

Motor Mounts



Contents



Features	1
Rapid Fit	2
Standard	3
Slide Rails	4

Motor Mounts



Features

Rapid Fit

- Available in five sizes covering motor frames 63 to 180
- Manufactured from cold rolled steel plate making them extremely durable
- Galvanised to protect against the elements
- Easily adjustable to accommodate more than one motor size and also adjust the belt tension
- No drilling necessary

Standard Motor Mounts

- Available in three sizes covering motor frames 63 to 225
- Manufactured from cold rolled steel plate making them extremely durable
- Stove enamelled finish with zinc plated adjustment screws to protect against the elements
- Requires drilling to accommodate various motor sizes

Slide Rails

- Available in seven sizes covering motor frames 63 to 255
- Manufactured from steel
- Galvanised to protect against the elements
- Easily adjustable

Rapid Fit Motor Mounts

Specification

The fastest and most economical method of securing motors to machine beds. The five sizes are manufactured from cold rolled steel and then galvanised. They can accommodate motor frame sizes 63 to 180 and have four slotted holes for fastening the base to the foundation.

Alignment

The pressed top plate is designed to slide over the base plate preventing vibration and noise whilst ensuring continuous belt alignment. Belts are tensioned by adjusting a single screw.

Motor Mounting

The motor is bolted to the two piece top plate which accommodates a wide range of motors. Centre distance adjustments can be made without the need to loosen the motor bolts.

Rapid Fit Motor Mount Fitting Instructions

1. Slightly loosen the two bolts holding the Cap (A), just in front of the hex adjustment nut
2. Lightly oil the shaft under this cap
3. Lightly oil the shaft thread where it enters the adjustment plate (B)
4. Adjust the base to accommodate the required motor
5. Tighten the two bolts (A) again, thus locking the Motor Mount in position

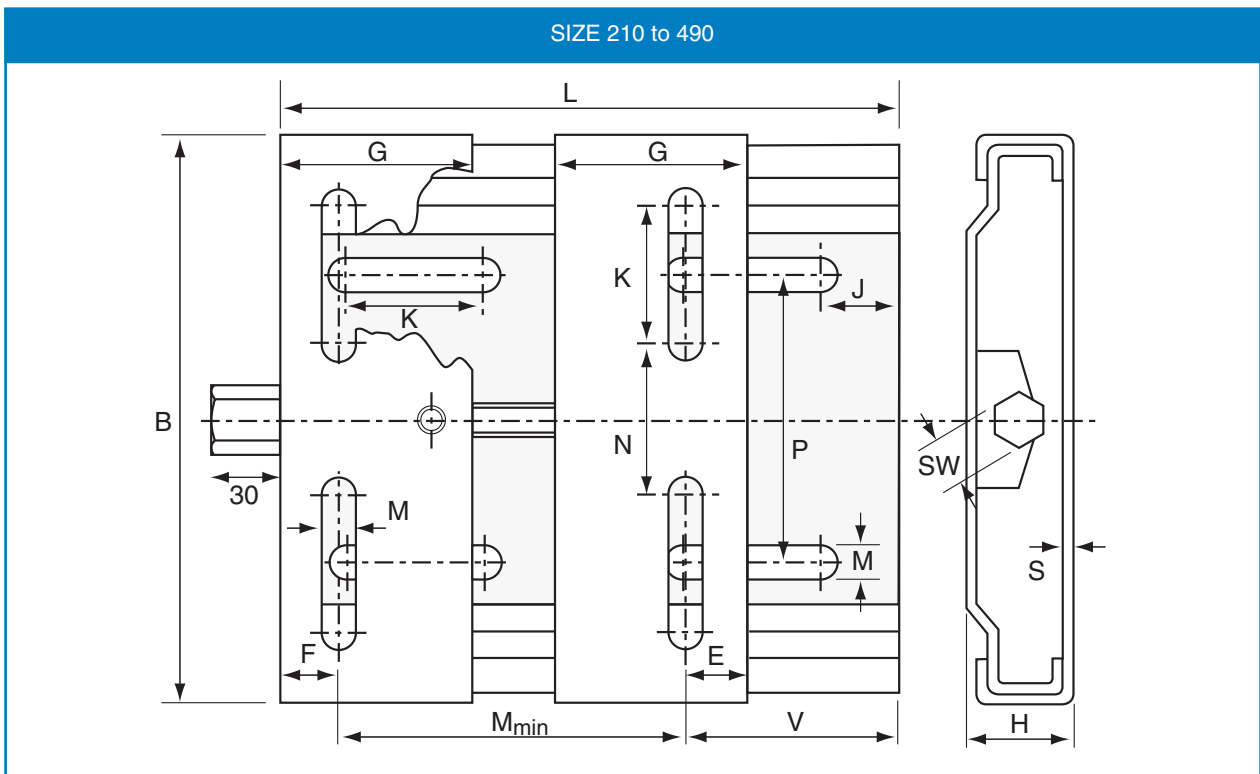
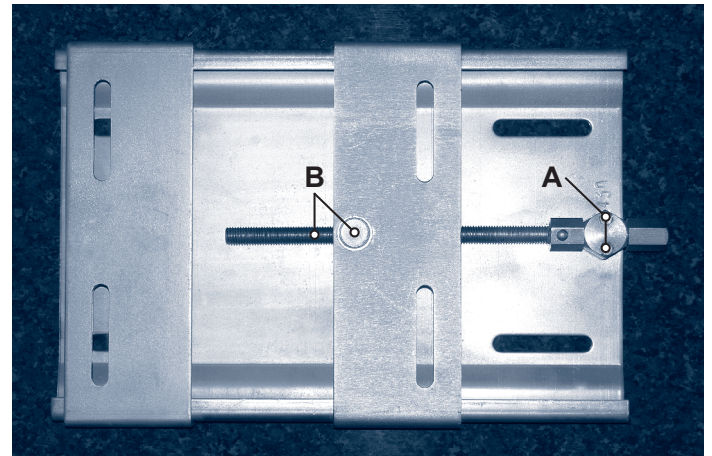

Dimensions for Sizes 210 to 490 Rapid Fit Motor Mount

Type	Frame Size	L	B	H	Mmin	G	E	J	K	M	N	P	SW	S	Weight kg
210	63 - 80	210	195	34	100	70	20	25	50	10.5	43	98	19	3	2.4
270	63 - 112	270	195	33	100	70	20	25	50	10.5	43	98	19	3	2.8
340	90 - 132	340	280	40	135	95	27	30	62	12.5	90	165	22	4	7.4
430	90 - 160	430	282	40	132	95	27	29	62	12.5	90	165	22	4	8.0
490	160 - 180	490	410	40	114	95	40	30	60	15.0	193	284	22	4	12.0

All dimensions in millimetres unless otherwise stated. Every effort has been taken to ensure that the data listed in this catalogue is correct. Challenge accepts no liability for any inaccuracies or damage caused.

Standard Motor Mounts

Specification

Produced in three sizes for motors from frame size 63 to 225 and manufactured from pressed steel fabrications with four slotted holes for fastening the base to the foundation.

Alignment

The pressed top plate is designed to slide exactly over the mounting rails preventing vibration and noise whilst ensuring continuous belt alignment. Belts are tensioned by adjusting a single screw which is possible whilst the motor is running.

Surface Finish

Stove enamelled finish with zinc plated adjustment screws to prevent corrosion.

Motor Mounting

The top plate requires drilling to accommodate the required motor mounting bolts. Centre distance adjustments can be made without the need to loosen the motor bolts.

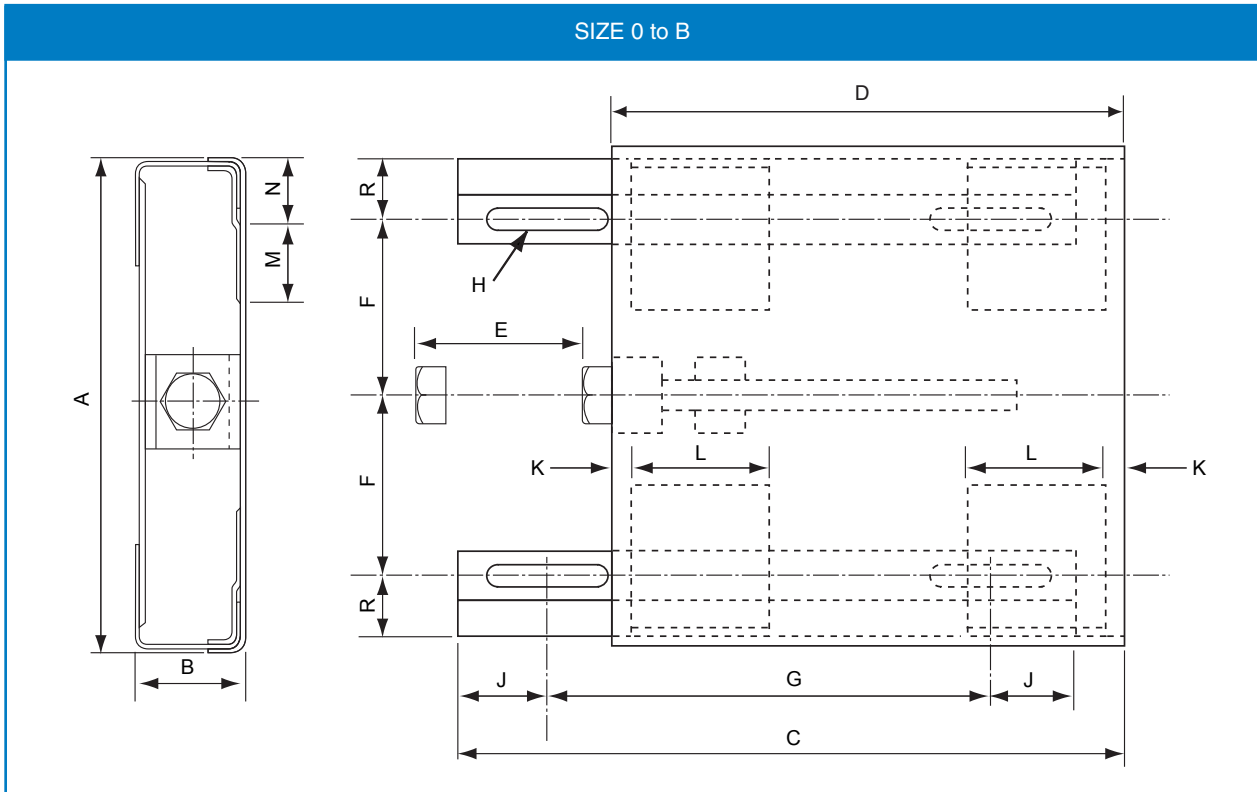

Dimensions for Sizes 0 to B Motor Mounts

Base Ref	Motor Frame Ref	Motor Bolt Holes	Movement														Weight kg	
			A	B	C	D	E	F	G	H	J	K	I	M	N	R		SW
0	63 71	7	146	29	225	170	80	55.0	148	9.5 x 25	27	60	50	32	18	15.0	17	1.4
A	80 90S 90L	10	240	55	325	258	100	89.0	215	13 x 51	45	10	70	51	32	28.5	24	5.3
	100S 100L 112S 112M 132S	12																
	132M	12																
	160M 160L 180M 180L	15																
	200M 200L 225S 225M	19																
B			428	60	578	450	180	172.5	370	17 x 50	51	28	100	98	42	36.0	24	19.0

Every effort has been taken to ensure that the data listed in this catalogue is correct. Challenge accepts no liability for any inaccuracies or damage caused. All dimensions in millimetres unless otherwise stated.

Slide Rails

Specification

Covering frame sizes 63 to 225, Challenge slide rails are manufactured in galvanised steel with movable positioning blocks for rapid accurate drive alignment.

Alignment

The pressed steel rails are solidly fixed by three securing bolts while the motor is bolted to the rails eradicating vibration and noise whilst ensuring rigid positioning.

Motor Mounting

The motor is bolted to the slide rails and positioned with the aid of adjustment screws. The motor must be stopped and the motor bolts loosened before repositioning.

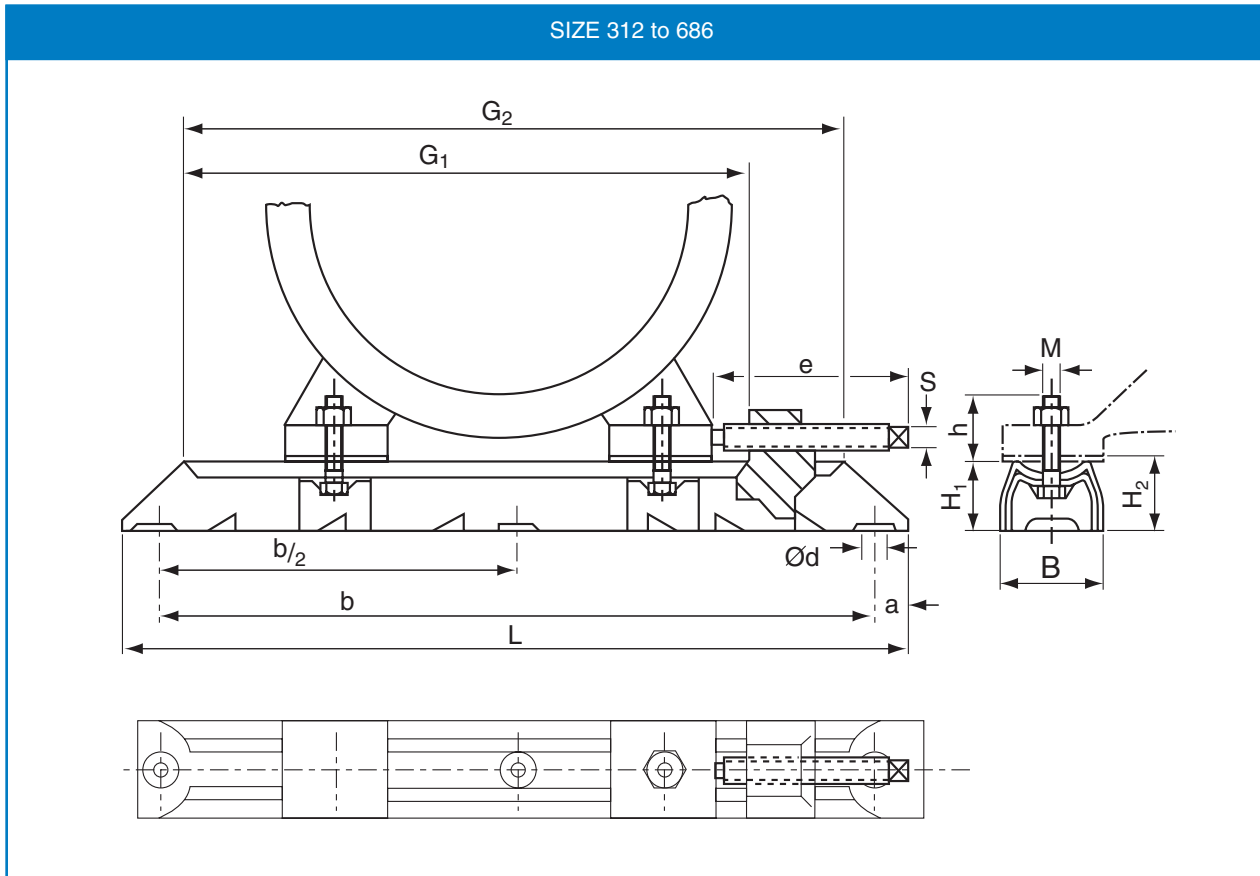

Dimensions for Sizes 312 to 686 Slide Rails

Base Ref	Overall Length L	Slide Length G ₁	Motor Frame Ref	M x h	I x S	G ₂	a	b	b/2	Ø d	B	H ₁	H ₂	Weight kg
312/6	312	240	63/71	M6 x 19	75 x 6	262	16	280	-	12	40	28	30	1.4
312/8	312	240	80/90	M8 x 27	75 x 6	262	16	280	-	12	40	28	30	1.5
375/6	375	305	63/71	M6 x 19	75 x 6	325	16	343	-	12	40	26	30	1.5
375/8	375	305	80/90	M8 x 27	75 x 6	325	16	343	-	12	40	28	30	1.6
375/10	375	305	100/112	M10 x 32	75 x 6	325	16	343	-	12	40	28	30	1.6
395/8	395	302	80/90	M8 x 28	97 x 8	325	20	355	-	12	50	40	43	3.4
395/10	395	302	100/112	M10 x 35	97 x 8	325	20	355	-	12	50	40	43	3.4
495/8	495	405	80/90	M8 x 29	97 x 8	425	20	455	-	12	50	40	43	4.0
495/10	495	405	100/112/132	M10 x 35	97 x 8	425	20	455	-	12	50	40	43	4.0
495/12	495	405	160	M12 x 49	97 x 8	425	20	455	-	12	50	40	43	4.0
530/10	530	413	132	M10 x 37	119 x 9	442	25	480	-	14	60	50	54	6.4
530/12	530	413	160	M12 x 49	119 x 9	442	25	480	-	14	60	50	54	6.4
630/10	630	515	132	M10 x 37	119 x 9	542	25	580	-	14	60	50	54	8.2
630/12	630	515	160/180	M12 x 45	119 x 9	542	25	580	-	14	60	50	54	8.2
686/12	686	538	160/180	M12 x 43	154 x 12	575	28	630	315	18	75	60	64	12.8
686/16	686	538	200/225	M16 x 62	154 x 12	575	28	630	315	18	75	60	64	12.8

All dimensions in millimetres unless otherwise stated. Every effort has been taken to ensure that the data listed in this catalogue is correct. Challenge accepts no liability for any inaccuracies or damage caused.

Notes

Notes

All dimensions in millimetres unless otherwise stated. Every effort has been taken to ensure that the data listed in this catalogue is correct. Challenge accepts no liability for any inaccuracies or damage caused.

Notes

Pillow blocks



Flange Units



Plummer Blocks



Pop Metric Bearings



Taper Roller Bearings

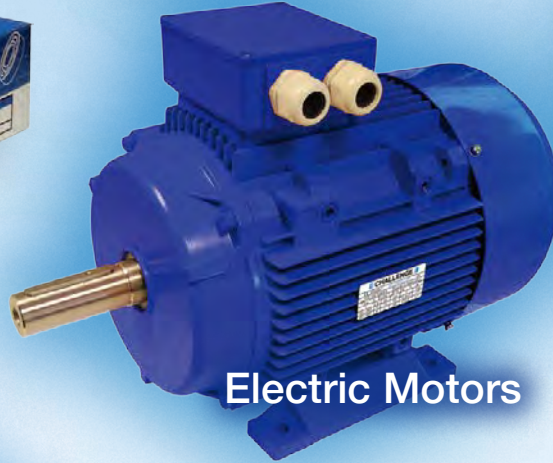

Electric Motors

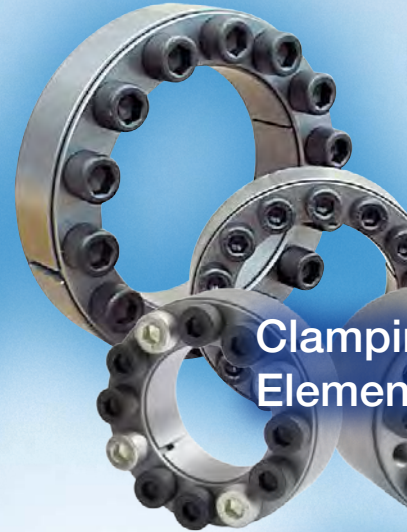

Clamping Elements

Transmission Sprockets



Conveyor Sprockets



All types of Chain



RPX Couplings

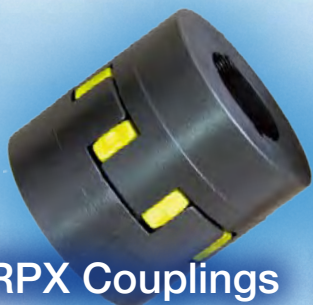

HRC Couplings



CNM Couplings



Jaw Couplings





Taper bushes

Bolt on Hubs

Taper Bore Pulleys

ng
ts

Shaft Mounted
Speed Reducers

Weld on Hubs

FFX Couplings

Synchronous
Belts

Vee Belts

Geared Drives

Torque
Limiters

af Chain

CRE Belts

Chain
Couplings

NPX Couplings

Motor Slide Bases

Timing Pulleys

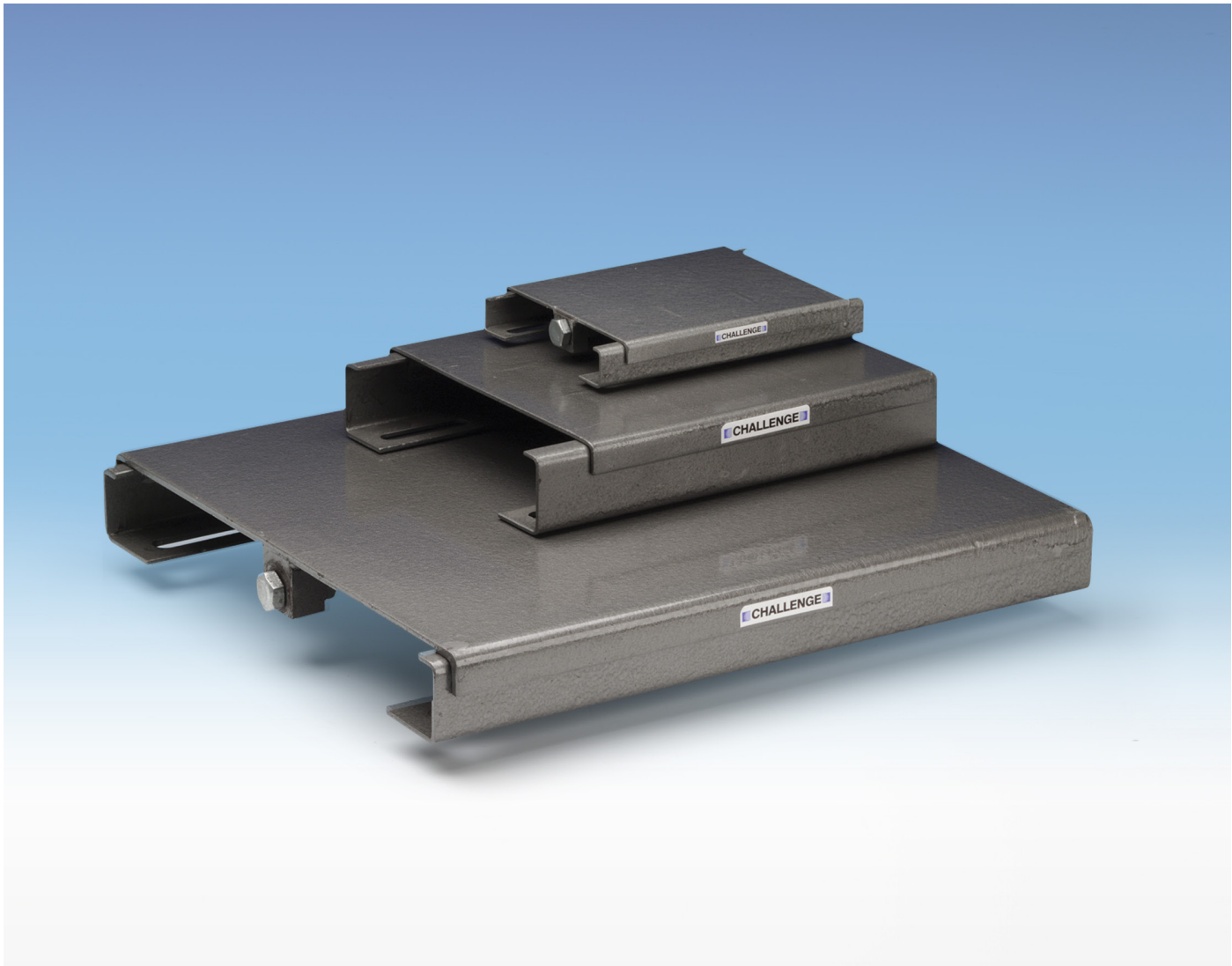

CHAIN & DRIVES®

chainanddrives.com.au
support@chainanddrives.com.au

Never a problem always a ...

CHALLENGE®

