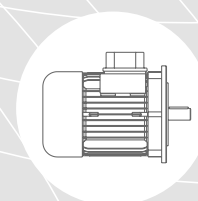
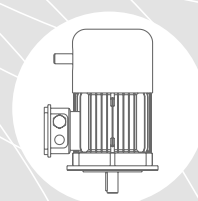
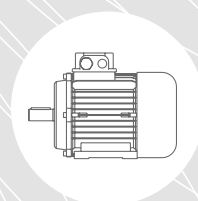




# ELECTRONIC Motive



DISTRIBUTED BY



**CHAIN & DRIVES**<sup>®</sup>  
COMPLETE BEARINGS  
& POWER TRANSMISSION

**SERVICE & SUPPORT**

Wangara, WA      Welshpool, WA      Arndell Park, NSW  
+61 8 9303 4966    +61 8 6314 1155    +61 2 9674 8611  
support@chainanddrives.com.au    salesnsw@chainanddrives.com.au

[chainanddrives.com.au](http://chainanddrives.com.au)

CATALOGO TECNICO  
TECHNICAL CATALOGUE


CT18 IGDB 1.0 | ITA - ENG - DEU

<b>A</b>	MOTORI ELETTRICI TRIFASE E MONOFASE <i>THREE-PHASE AND SINGLE-PHASE ELECTRIC MOTORS</i> DREHSTROM- UND EINPHASENMOTOREN	<b>A3</b>
<b>B</b>	MOTORI ELETTRICI TRIFASE SERIE VL <i>VELA ELECTRIC MOTORS</i> VELA ELEKTROMOTOREN	<b>B1</b>
<b>C</b>	INVERTER (STM DRIVE) <i>INVERTER (STM DRIVE)</i> FREQUENZUMRICHTER (STM DRIVE)	<b>C1</b>
<b>D</b>	ESV ESV ESV	<b>D1</b>
<b>Z</b>	WEB SITE MAP	<b>Z1</b>
	Gestione Revisione Cataloghi STM <i>Managing STM Catalog Revisions</i> Management Wiederholt Kataloge STM	<b>Z2</b>

**SIMBOLOGIA**

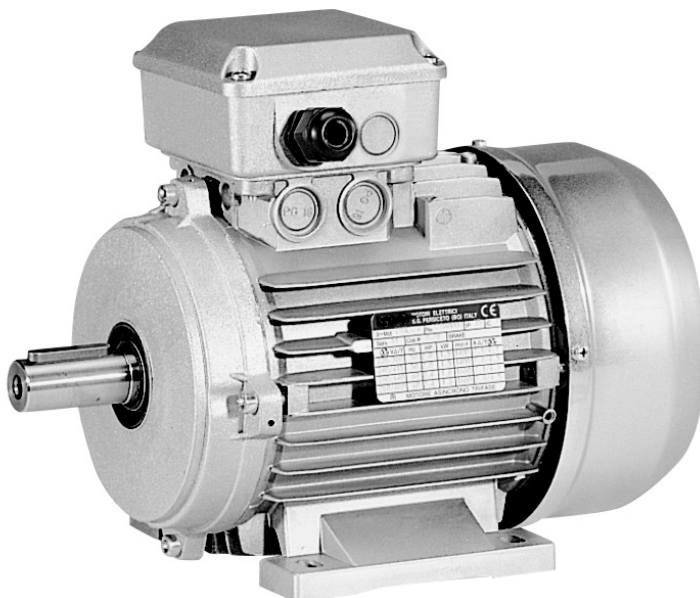
**SYMBOLS**

**VERWENDETE SYMBOLE**

Simbolo Symbols Symbol	Unità di misura Unit of measurement Maßeinheit	DEFINIZIONE	DEFINITION	DEFINITION
<b>Ca</b>	[Nm]	Coppia di avviamento	<i>Starting torque</i>	Startmoment
<b>C<sub>B</sub></b>	[Nm]	Coppia base	<i>Basetorque</i>	Grundmoment
<b>CF</b>	[Nm]	Coppia frenante	<i>Brake torque</i>	Bremsemoment
<b>C<sub>L</sub></b>	[Nm]	Coppia limite	<i>Limit torque</i>	Grenzemoment
<b>C<sub>max</sub></b>	[Nm]	Coppia massima	<i>Max. torque</i>	Höchstmoment
<b>C<sub>n</sub></b>	[Nm]	Coppia nominale	<i>Rated torque</i>	Nennmoment
<b>cosφ</b>	—	Fattore di potenza	<i>Power factor</i>	Leistungsfaktor
<b>Cr</b>	[Nm]	Coppia resistente	<i>Counter-torque during acceleration</i>	Lastmoment
<b>C<sub>VF</sub></b>	[μF]	Capacità condensatore	<i>Capacitor capacity</i>	Kondensatorkapazität
<b>F<sub>a</sub></b>	[N]	Carico assiale	<i>Axial Load</i>	Axialbelastung
<b>f<sub>B</sub></b>	[Hz]	Frequenza base	<i>Base Frequency</i>	Grund frequenz
<b>f<sub>L</sub></b>	[Hz]	Frequenza limite	<i>Limit frequency</i>	Grenze frequenz
<b>f<sub>max</sub></b>	[Hz]	Frequenza massima	<i>Max. frequency</i>	Höchst frequenz
<b>F<sub>r</sub></b>	[N]	Carico radiale	<i>Radial load</i>	Radialbelastung
<b>η</b>	—	Rendimento	<i>Efficiency</i>	Wirkungsgrad
<b>I<sub>a</sub></b>	[A]	Corrente di spunto	<i>Locked rotor current</i>	Kurzschlußstrom
<b>I<sub>n</sub></b>	[A]	Corrente nominale	<i>Rated current</i>	Nennstrom
<b>J<sub>c</sub></b>	[Kgm <sup>2</sup> ]	Momento di inerzia del carico	<i>Load moment of inertia</i>	Massenträgheitsmoment der externen Massen
<b>J<sub>m</sub></b>	[Kgm <sup>2</sup> ]	Momento di inerzia motore	<i>Moment of inertia</i>	Trägheitsmoment
<b>n<sub>B</sub></b>	[min <sup>-1</sup> ]	Velocità base	<i>Base speed</i>	Grund drehzahl
<b>n<sub>L</sub></b>	[min <sup>-1</sup> ]	Velocità limite	<i>Limit speed</i>	Grenze drehzahl
<b>n<sub>max</sub></b>	[min <sup>-1</sup> ]	Velocità massima	<i>Max. speed</i>	Höchst drehzahl
<b>n<sub>n</sub></b>	[min <sup>-1</sup> ]	Velocità nominale	<i>Rated speed</i>	Nenn Drehzahl
<b>P<sub>B</sub></b>	[W]	Potenza assorbita dal freno a 20° C	<i>Power drawn by the brake at 20°C</i>	Leistungs auf nahme der Bremse bei 20°C
<b>P<sub>L</sub></b>	[kW]	Potenza limite	<i>Limit power</i>	Grenzeleistung
<b>P<sub>max</sub></b>	[kW]	Potenza massima	<i>Max. power</i>	Max. Leistung
<b>P<sub>n</sub></b>	[kW,HP]	Potenza nominale motore	<i>Motor rated power</i>	Nennleistung
<b>P<sub>v</sub></b>	[W]	Potenza servoventilazione	<i>Cooling fan power</i>	Servoleiftung leistung
<b>Sc</b>	—	Capacità di spunto	<i>Starting capacity</i>	Startkapazität
<b>VB</b>	[m <sup>3</sup> /min]	Portata aria di raffreddamento	<i>Capacity cooling air</i>	Kühlluft der Kapazität
<b>V<sub>n</sub></b>	[V]	Tensione nominale	<i>Nominal voltage</i>	Nennspannung
<b>Z<sub>c</sub></b>	[1/h]	N° di avviamenti ammissibili a carico		
<b>Z<sub>0</sub></b>	[1/h]	N° di avviamenti ammissibili a vuoto (I = 50%)	<i>Max. permissible no-load starting frequency (I=50%)</i>	Max. Schalthäufigkeitim Leerl auf (relative Einschalt-dauerl=50%)
	[Kg]	Peso	<i>Weight</i>	Maße

**1.0 MOTORI TRIFASE E MONOFASE****THREE-PHASE AND SINGLE-PHASE ELECTRIC MOTORS  
DREHSTROM- UND EINPHASENMOTOREN****T-TA,D-DA,H-HA,I-IA.R-RA,  
S-SA,M-MA,MD-MDA,  
MF-MFA,MC**

				Pag. Page Seite
1.1	Generalità	<i>General information</i>	Allgemeines	A4
1.2	Designazione	<i>Designation</i>	Bezeichnungen	A12
1.3	Caratteristiche meccaniche	<i>Mechanical characteristics</i>	Mechanische Ausführung	A16
1.4	Caratteristiche elettriche	<i>Electrical specifications</i>	Elektrische eigenschaften	A26
1.5	Opzioni	<i>Options</i>	Optionen	A31
1.6	Motori asincroni autofrenanti	<i>Self-braking</i>	Selbstbremsende Asynchronmotoren	A37
1.7	Dati tecnici	<i>Technical specifications</i>	Technische Daten	A50
1.8	Dimensioni	<i>Dimensions</i>	Abmessungen	A72



## 1.1 GENERALITÀ

## 1.1 GENERAL INFORMATION

## 1.1 ALLGEMEINES

## Norme di riferimento

## Reference standards

## Bezugsnormen

Norme Standards	IEC (World)	CENELEC (Europe)	CEI (Italy)	UNEL (Italy)	DIN (Germany)	VDE (Germany)	BS (U.K.)	NFC (France)	UL* (USA)	NEMA* (USA)	CAN-CSA* (Canada)
Caratteristiche elettriche <i>Electrical specifications</i> Elektrische Merkmale	IEC 34-1	HD 53.1.S2	CEI EN 60034-1			VDE 0530T1	BS 2613 5000	NFC 51-100 51-120	UL 1004	NEMA MG1	CSA 22.2 No. 100
Grado di protezione <i>Protection class</i> Schutzart	IEC 34-5	EN 60034-5	CEI EN 60034-5	UNEL 05515	DIN 40050	VDE 0530	BS 4999-20	NFC 51-115	UL 1004	NEMA MG1	CSA 22.2 No. 100
Metodo ventilazione motori <i>Motor ventilation system</i> Methode der Motorenbelüftung	IEC 34-6	EN 60034-6			DIN IEC 34-6		BS 4999-21			NEMA MG1	
Forme costruttive <i>Configurations</i> Bauformen	IEC 34-7	HD 53.7	CEI EN 60034-7	UNEL 05513	DIN 42950			NFC 51117		NEMA MG1	
Limiti di rumorosità <i>Noise limits</i> Geräuschlimits	IEC 34-9		CEI EN 60034-9								
Voltaggi unificati <i>Standardized voltages</i> Genormte Spannungen	IEC 38		CEI 8-6					NFC 6	UL 1004	NEMA MG1	CSA 22.2 No. 100
Caratteristiche dimensionali <i>Sizes and dimensions</i> Abmessungen	IEC 72-1		CEI IEC 74-1	UNEL 13113 13117 13118	DIN 42673 42677 42946		BS 3979	NFC 51-105 51-120		NEMA MG1	
Sicurezza del macchinario equipaggiamento elettrico delle macchine <i>Machinery safety electric equipment of the machines</i> Sicherheit der Anlage und der elektrischen Ausrüstung der Maschinen			CEI EN 60204-1								

\* a richiesta / \* upon request / \* auf Anfrage

## Marcatura CE

I motori industriali del presente catalogo sono costruiti in conformità alla normativa **IEC 60034** la quale include la Direttiva Bassa Tensione CEE 73/23 (1973), modificata con CEE 93/68 (1993) e la direttiva EMC CEE 89/336.

I nostri motori sono conformi inoltre alla Direttiva Macchine 98/37/CEE rilevando che **il componente motore non potrà essere messo in servizio prima che la macchina, in cui esso sarà incorporato, sia stata dichiarata conforme alle disposizioni della direttiva.**

Ai fini della sicurezza è applicata la norma EN 60204-1 (Equipaggiamento elettrico delle macchine) e delle avvertenze generali sulla sicurezza riportate nel manuale d'uso del costruttore.

## CE mark

*The industrial motors in this catalogue are manufactured conforming to IEC 60034 standard which includes the Low Voltage Directive CEE 73/23 (1973), revised by CEE 93/68 (1993) and the EMC CEE 89/336 directive.*

*Our motors also comply with Machine Directive 98/37/CEE which states that **the motor component may not be put into service until the machine into which it is incorporated has been declared to comply with the rules of the directive.***

*In the interests of safety, standard EN 60204-1 (Machine electrical equipment) is applied as well as general safety warnings given in the manufacturer's User manual.*

## EG-Kennzeichnung

Die in diesem Katalog aufgeführten Motoren für den industriellen Einsatz sind gemäß der Norm **IEC 60034** gebaut, die die Richtlinie 73/23/EWG (1973) für Niederspannung, geändert durch die Richtlinie 93/68/EWG (1993), und die Richtlinie EMC 89/336/EWG umfasst.

Unsere Motoren stimmen ferner mit der Richtlinie 98/37/EWG für Maschinen überein. Hierbei wird herausgestellt, dass das **Bauteil Motor erst in Betrieb genommen werden kann, nachdem die Maschine, in die er eingebaut ist, in Übereinstimmung mit den Bestimmungen der Richtlinie erklärt wurde.**

Für die Sicherheit kommen die Norm EN 60204-1 (Elektrische Ausrüstung von Maschinen) und die allgemeinen Sicherheitshinweise aus der Betriebsanleitung des Herstellers zur Anwendung.

## Omologazione (USA - Canada)



Su richiesta sono possibili, previo accordo sulle quantità con la STM SpA, forniture di motori marcati secondo Norma UL 1004 Standard for Safety e Norma CAN/CSA C22.2 No. 100 Motors and Generators.

## Approval

(USA - Canada)

*Upon agreement as to the quantities supplied by STM SpA, motors marked for approval by UL 1004 Standard for Safety and CAN/CSA-C22.2 standard No. 100, Motors and Generators, are available for supply.*



## Zulassung

(USA - Canada)

Die STM SpA liefert auf Wunsch bei vereinbarten Mengen Motoren nach UL 1004 (Standard for Safety) und nach CAN/CSA-C22.2 No. 100 (Motors and Generators).

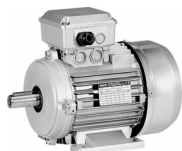


## MOTORI TRIFASE / THREE-PHASE MOTORS / DREHSTROMMOTOREN

## Motori asincroni trifase

## Three-phase induction motors

## Drehstrom-asynchronmotoren



Serie / Series/ Serie	Designazione	<i>Designation</i>	Typenschlüssel	A12
<b>T - TA</b> <b>D - DA</b>	Caratteristiche meccaniche	<i>Mechanical characteristics</i>	Mechanische Ausführung	A16
	Caratteristiche elettriche	<i>Electrical characteristics</i>	Elektrische Ausführung	A26
Grand. / Size / Größe 50...160	Collegamenti morsettiera	<i>Terminal board connections</i>	Klemmenanschlüsse	A29
	Opzioni	<i>Options</i>	Optionen	A31
	Freno	<i>Brake</i>	Bremse	A37
	Dati tecnici	<i>Technical specifications</i>	Technische Daten	A52
	Dimensioni	<i>Dimensions</i>	Abmessungen	A72

I motori asincroni sono con rotore a gabbia di scoiattolo pressofusa, statore avvolto, chiusi, ventilati esternamente secondo IEC 34-6.

*The induction motors we produce have die-cast squirrel cage motor and wound stator, are enclosed and have external cooling to IEC 34-6.*

Alle unsere Asynchronmotoren haben einen druckgegossenen Käfigläufer, gewickelten Stator und sind geschlossen und außenbelüftet nach IEC 34-6.

## Motori ad alta efficienza (EFF1)

## High efficiency motor (EFF1)

## High efficiency motor (EFF1)



Serie / Series/ Serie	Designazione	<i>Designation</i>	Typenschlüssel	A12
<b>H</b> <b>HA</b>	Caratteristiche meccaniche	<i>Mechanical characteristics</i>	Mechanische Ausführung	A16
	Caratteristiche elettriche	<i>Electrical characteristics</i>	Elektrische Ausführung	A26
Grand. / Size / Größe 56...160	Collegamenti morsettiera	<i>Terminal board connections</i>	Klemmenanschlüsse	A29
	Opzioni	<i>Options</i>	Optionen	A31
	Freno	<i>Brake</i>	Bremse	A37
	Dati tecnici	<i>Technical specifications</i>	Technische Daten	A52
	Dimensioni	<i>Dimensions</i>	Abmessungen	A72

Progetto di elevato contenuto tecnologico e di caratteristiche innovative per quanto riguarda la tecnologia utilizzata, studiato per applicazioni generali. L'efficienza rispetto un motore standard è incrementata nel range del (5-10)%, funzione del tipo che si considera.

In generale l'alta efficienza comporta un risparmio energetico notevole con grossi consumi, quindi con molti motori o di elevata potenza.

*Design with high level of technology, with new characteristics of construction, multipurpose applications for save energy. Efficiency, is increased on range of (5 - 10)%, in function of motor type. In general high efficiency save energy with high power applications, with a lot of motors or with high power motors.*

Für allgemeine Anwendungen entwickeltes Projekt auf hohem technologischem Niveau mit innovativen Merkmalen hinsichtlich der eingesetzten Technologie. Je nach Motortyp wurde der Wirkungsgrad gegenüber einem Standardmotor um 5-10% gesteigert.

Im Allgemeinen garantiert der hohe Wirkungsgrad eine bemerkenswerte Reduzierung des Energieverbrauchs insbesondere bei Großverbrauchern, d.h. beim Einsatz vieler Motoren oder von Motoren hoher Leistung.

## MOTORI TRIFASE / THREE-PHASE MOTORS / DREHSTROMMOTOREN

## Motori per inverter

## Inverter motors

## Invertermotoren



Serie / Series/ Serie	Designazione	Designation	Typenschlüssel	
<b>I - IA</b>	Caratteristiche meccaniche	Mechanical characteristics	Mechanische Ausführung	A12
	Caratteristiche elettriche	Electrical characteristics	Elektrische Ausführung	A16
	Collegamenti morsetteria	Terminal board connections	Klemmenanschlüsse	A26
	Opzioni	Options	Optionen	A29
	Freno	Brake	Bremse	A31
	Dati tecnici	Technical specifications	Technische Daten	A37
	Dimensioni	Dimensions	Abmessungen	A52
				A72

Dal punto di vista meccanico, data l'equilibratura dei rotanti di grado G6.3 secondo ISO 1940-UNI 4218, a discrezione ufficio tecnico, si possono raggiungere in zona di deflussaggio circa 3 volte la velocità nominale del motore, senza contatti rotore statore. È presente un inserto in acciaio nella sede del cuscinetto che permette con una certa sicurezza di evitare movimenti radiali dell'anello esterno (a discrezione ufficio tecnico). In questo tipo di motori il cuscinetto è precaricato da un anello elastico appropriato, che elimina i giochi meccanici residui all'interno dei cuscinetti stessi. Essendo ancora i nostri cuscinetti a una corona di sfere in grado di girare senza problemi, per le grandezze da noi utilizzate, a velocità di rotazione dell'ordine di 10000 rpm (giri/minuto) ciò è ulteriore garanzia di durata e silenziosità del motore. Dal punto di vista elettrico si vuole ancora fare presente che molti motori sono realizzati con avvolgimenti speciali a doppio strato e passo raccorciato, con lo scopo di eliminare armoniche indesiderate di coppia, per soddisfare le esigenze di controlli a velocità variabile.

Sono sempre utilizzate lamiere magnetiche a bassa perdita  $C_p=10W/Kg$  a  $50Hz/1T$ , con rapporto favorevole (cave statore/cave rotore). Sono utilizzati sistemi di isolamento speciali, rinforzati. Indicativamente, con questo tipo di motore si può deflussare circa 2 volte, mantenendo costante la potenza di targa ( $2p - 6000 \text{ min}^{-1}$ ). Ciò per motori 2 e 4 poli, alimentati alla tensione massima di targa stellata Y. Si può ancora utilizzare questo tipo di motore collegato a  $\Delta$  (e alimentato dall'inverter in modo da arrivare a coppia costante nominale, alla V nominale stellata Y (vedi figura sotto), con verifica del servizio termico.

Esempio: un motore 230V/400V/50 Hz si collega a  $\Delta$  (e lo si porta a coppia costante fino a 400V/87Hz. Le potenze disponibili indicativamente sono quelle da catalogo.

Se si scende a funzionare al di sotto dei 50Hz, o a caratteristiche diverse dalle nominali di targa, è imposto l'uso della servoventilazione.

*From a mechanical standpoint, given the grade G6.3 rotary balance per ISO 1940-UNI 4218, at discretion of technical office, in the defluxing area it is possible to achieve approximately 3 times the rated motor speed without rotorstator contacts.*

*A steel insert is provided in the bearing slot that prevents radial movement by the outer ring with a fair degree of security (at discretion of technical office).*

*In this type of motor, the bearing is pre-charged with an appropriate elastic ring that eliminates residual mechanical clearance within the bearing itself.*

*As our row radial ball bearings are still able to turn without problems for the sizes we use at rotation speeds around 10000 rpm, this is additional insurance of long motor life and low noise levels.*

*From an electrical standpoint, we also wish to point out that many motors are built with special duallayer and shortened-pitch windings for the purpose of eliminating undesired torque harmonics and satisfy the need for variable-speed controls. Low-leak magnetic sheet metals  $C_p = 10W/Kg$  at  $50 \text{ Hz}/1T$  are always used with a favorable ratio (stator slots/rotor slots). Special, reinforced insulation systems are used.*

*Generally speaking, it is possible to deflux approximately 2 times with this type of motor while keeping the rated power constant ( $2p - 6000 \text{ rpm}$ ).*

*This holds for 2- and 4-pole motors powered at the maximum rated star voltage Y. This type of motor may also be used connected to  $\Delta$  (and powered by the inverter to achieve a constant rated torque at the rated star voltage Y – see figure below), with thermal duty control.*

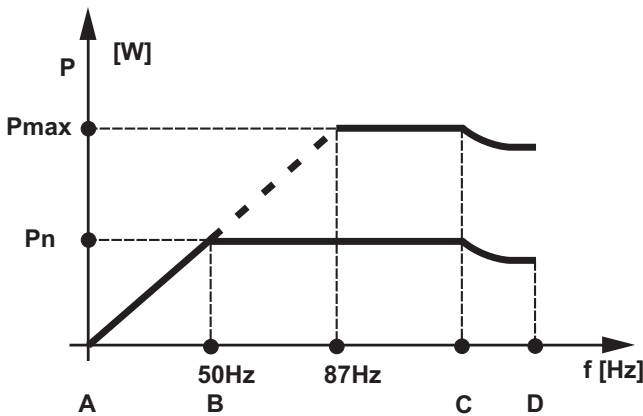
*Example: a 230V/400V/50 Hz motor is connected to  $\Delta$  and taken to 400V/87 Hz at constant torque. The available powers are more or less those listed in the catalogue. If the motor operates below 50 Hz, or with specifications other than the rated listings, power cooling is required.*

Aufgrund der Auswuchtung der rotierenden Teile vom Grade G 6.3 nach ISO 1940-UNI 4218 kann von der Mechanik her im Bereich der verminderten Stromentnahme circa die dreifache Nenndrehzahl des Motors ohne Kontakt zwischen Läufer und Stator erreicht werden. Um Radialbewegungen des äußeren Rings weitgehend auszuschließen, wurde der Sitz des Lagers mit einem Einsatz aus Stahl versehen (nach Ermessen der technischen Abteilung). Das Lager wird bei dieser Art von Motoren durch einen geeigneten elastischen Ring vorgespannt, der das in den Lagern verbliebene mechanische Spiel beseitigt. Unsere Lager mit einem Kugelkranz sind großdimensioniert und sind problemlos für Drehzahlen bis zu  $10000 \text{ min}^{-1}$  einsetzbar. Außerdem gewährleisten sie eine lange Lebensdauer und einen ruhigen Lauf des Motors.

Durch den Einsatz von Spezialwicklungen mit doppelter Lackschicht und vermindertem Wicklungsschritt werden, um den Anforderungen der Überwachung wechselnder Drehzahlen zu genügen, Oberschwingungen vermieden. Auch in diesem Fall werden Magnetbleche mit einem niedrigen Verlustfaktor von  $C_p=10W/kg$  bei 50 Hz mit einem günstigen Verhältnis zwischen Stator- und Läuferfritzen sowie besonders verstärkte Isoliersysteme eingesetzt. Mit dieser Art von Motor kann die Stromentnahme bei gleichbleibender Leistung um etwa die Hälfte vermindert werden ( $2p - 6000 \text{ min}^{-1}$ ), d.h. bei 2- und 4-poligen Motoren auf die max. Sternspannung Y des Typenschildes. Dieser Motor kann außerdem in  $\Delta$ -Schaltung (invertergespeist) verwendet werden, so daß bei max. Sternspannung Y ein konstantes Nennmoment erreicht wird (siehe Abbildung unten) mit Überwachung des thermischen Verhaltens.

Beispiel: Ein Motor von 230V/400V/50Hz ist in  $\Delta$ -Schaltung angeschlossen (und wird dann auf das konstante Drehmoment bis 400V/87Hz gebracht). Die verfügbaren Leistungen sind im Katalog angegeben. Wenn der Motor unter 50Hz oder mit von den Typenschild-Nennwerten abweichenden Werten betrieben wird, muß eine Servobelüftung vorgesehen werden.

MOTORI TRIFASE / THREE-PHASE MOTORS / DREHSTROMMOTOREN



- B** Frequenza di base / Base frequency / Grundfrequenz
- C** Frequenza massima / Maximum frequency / Höchstfrequenz
- D** Frequenza limite / Limit frequency / Grenzfrequenz

Motore collegato a A  
**P<sub>n</sub>**= potenza nominale motore (230V)  
**P<sub>max</sub>**= potenza massima (400V)

Motor connected to A  
**P<sub>n</sub>**= rated motor power (230V)  
**P<sub>max</sub>**= maximum power (400V)

Motor in A-Schaltung  
**P<sub>n</sub>**= Nennleistung des Motors (230V)  
**P<sub>max</sub>**= max. Leistung (400V)

Zone di funzionamento  
 (per collegamento standard):  
**AB**= zona a coppia costante  
**BC**= zona a potenza costante  
**CD**= zona a potenza calante

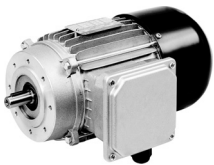
Operating areas  
 (for standard connection):  
**AB**= constant torque  
**BC**= constant power area  
**CD**= falling power area

Betriebsbereiche  
 (für Standardanschlüsse):  
**AB**= Bereich mit konstantem Drehmoment  
**BC**= Bereich mit konstanter Leistung  
**CD**= Bereich mit abnehmender Leistung

**Motori asincroni trifase  
 sincronizzati (riluttanza).  
 (secondo CEI EN 60034-1 / IEC**

**Synchronous asynchronous  
 threephase motors (reluctance)  
 (per CEI EN 60034-1 / IEC 34-1)**

**Drehstrom-Asynchronmotoren und  
 Synchronmotoren (Reluktanz).  
 (nach CEI EN 60034-1 / IEC 34-1)**



Serie / Series/ Serie	Designazione	Designation	Typenschlüssel	A12
<b>R RA</b>	Caratteristiche meccaniche	Mechanical characteristics	Mechanische Ausführung	A16
	Caratteristiche elettriche	Electrical characteristics	Elektrische Ausführung	A26
Grand. / Size / Größe 63...160	Collegamenti morsettiera	Terminal board connections	Klemmenanschlüsse	A29
	Opzioni	Options	Optionen	A31
	Freno	Brake	Bremse	A37
	Dati tecnici	Technical specifications	Technische Daten	A66
	Dimensioni	Dimensions	Abmessungen	A72

Motori speciali ad elevata tecnologia per applicazioni in cui è richiesta un'alta coppia di spunto e contemporaneamente il mantenimento della velocità di sincronismo. Il motore si avvia come un asincrono di elevate caratteristiche poi, se le condizioni di carico lo permettono, si sincronizza raggiungendo e mantenendo la velocità sincrona in funzionamento sincrono.

Esempio: un motore 4 Poli alimentato a 50 Hz., raggiunge esattamente i 1500 rpm a carico nominale. Indicativamente si ottengono potenze rese di regime, rispetto un motore da catalogo, nell'ordine del 40% in servizio S1 alle caratteristiche nominali di ingresso.

Special high-technology motors for applications requiring a high starting torque while maintaining the synchronous speed. The motor starts as a high-performance asynchronous motor; then, if load conditions permit, it synchronizes to achieve and maintain synchronous speed in synchronous mode. Example: a 4-pole motor powered at 50 Hz reaches exactly 1500 rpm at nominal load. Standard power outputs are generally achieved, in relation to a catalogue motor, at around 40% in S1 duty at the rated input.

Es handelt sich dabei um hochtechnologische Spezialmotoren für Anwendungsbereiche, in denen ein hohes Anzugsmoment und zugleich die Erhaltung der Synchrongeschwindigkeit i terforderlich ist. Der Motor startet wie ein hochleistungsfähiger Asynchronmotor, synchronisiert sich, sobald es die Last gestattet, und läuft dann mit Synchrongeschwindigkeit im Synchronbetrieb weiter.

Beispiel: Ein 4poliger Motor mit 50 Hz erreicht bei Nennlast genau 1500 Umdrehungen. Verglichen mit Standardmotoren werden Betriebsleistungen von 40% im S1-Betrieb bei gleichen Eingangsnennwerten erzielt.



## MOTORI TRIFASE / THREE-PHASE MOTORS / DREHSTROMMOTOREN

## Motori a scorrimento

## Slip motors

## Drehstrom-Schlupfmotoren



Serie / Series/ Serie	Designazione	Designation	Typenschlüssel	
<b>S - SA</b>	Caratteristiche meccaniche	<i>Mechanical characteristics</i>	Mechanische Ausführung	A12
	Caratteristiche elettriche	<i>Electrical characteristics</i>	Elektrische Ausführung	A16
Grand. / Size / Größe 71...132	Collegamenti morsetteria	<i>Terminal board connections</i>	Klemmenanschlüsse	A26
	Opzioni	<i>Options</i>	Optionen	A29
	Freno	<i>Brake</i>	Bremse	A31
	Dati tecnici	<i>Technical specifications</i>	Technische Daten	A37
	Dimensioni	<i>Dimensions</i>	Abmessungen	A62
				A72

Sono motori speciali, con impiego di tecnologie di progetto e costruzione moderne. Lo statore è avvolto, mentre il rotore è monoblocco ad alta resistenza in cortocircuito. La caratteristica principale di tale motore è la possibilità di funzionare a potenza costante al variare del numero di giri. In particolari condizioni il motore può rimanere a rotore bloccato senza che superi la temperatura alla classe di isolamento per cui è progettato. Per applicazioni speciali si può dotare il motore di servo ventilazione assistita assiale, con incrementi di coppia motrice a rotore bloccato elevati, rispetto il motore standard.

**Campo di utilizzazione.**

Il campo di applicazione usuale è quello dove si bobinano fili metallici, filati, nastri adesivi, reggetta, quindi nelle situazioni in cui al variare della velocità si desidera tiro costante del materiale per evitare di spezzarlo. Altra possibilità è di utilizzarlo come FRENO IN CONTROCAMPO, fino a circa la metà della velocità di sincronismo. Per applicazioni speciali contattare il nostro ufficio tecnico.

**Motori a scorrimento speciali e monofasi**

Si possono realizzare, motori a scorrimento monofasi e speciali, nelle varie forme e polarità, con caratteristiche di coppia motrice erogata su richiesta.

**Regolazione della coppia motrice**

Per regolare il valore della coppia motrice erogata, in funzione del tipo o materiale da trattare, si utilizzano dei variatori di tensione, con variazione della coppia motrice funzione quadratica della tensione applicata ai morsetti. La regolazione di tensione può essere fatta con dispositivi elettronici o meccanici che rilevano la tensione del filo e regolano la coppia motrice erogata dal motore di conseguenza, realizzando un sistema in retroazione ad anello chiuso.

*These are special motors that make use of up-to-date design and manufacturing technologies. The stator is wound whereas the rotor is monobloc and features high short-circuit resistance. The main characteristic of this motor is the possibility of working at constant power when the number of rpm changes. Under particular conditions the motor's rotor can stay locked without exceeding the rated temperature class for which it is designed. For special applications the motor can be equipped with axial servoassisted ventilation with high locked-rotor torque increments as compared to the standard motor.*

**Use range.**

*The usual range of application is for the winding of stitching wire, yarn, adhesive tape, steel band, etc., situations in which when the speed changes the material is to be pulled constantly and steadily to prevent it from breaking. Another possibility is that of using it as a BRAKE IN THE OPPOSING FIELD, up to about half the synchronism speed. As far as special applications are concerned, please contact our technical department.*

**Special and single-phase cumulatively compound motors**

*Single-phase and special cumulatively compound motors can be manufactured, in various shapes and polarities, with supplied torque features on request.*

**Torque adjustment**

*Voltage converters are used for adjusting the value of the supplied torque, depending on the type of material to be processed, with change of torque in quadratic function of the voltage applied to the terminals. Voltage is adjusted by means of electronic or mechanical devices that detect the tension of the wire and therefore regulate the torque supplied by the motor accordingly, creating a closed-ring feedback system.*

Hierbei handelt es sich um Spezialmotoren mit moderner Entwicklungstechnologie und Konstruktionstechnik. Der Stator ist gewickelt, während der Läufer aus einem Block mit hohem Kurzschlußwiderstand besteht. Das wichtigste Merkmal eines solchen Motors liegt in der Möglichkeit des Betriebs bei konstanter Leistung und variablen Drehzahlen. Unter besonderen Bedingungen überschreitet der Motor auch bei blockiertem Läufer die Temperatur der Isolierungskategorie, für die er entwickelt wurde, nicht. Für Sonderanwendungen kann der Motor mit einem axialen Servolüfter mit gegenüber dem Standardmotor erhöhtem Antriebsdrehmoment bei blockiertem Läufer geliefert werden.

**Einsatzbereich.**

Der normale Anwendungsbereich umfaßt die Wicklung von Metalldrähten, Zwirn, Klebändern, Bandisen, d.h. diese Motoren kommen in den Anwendungen zum Einsatz, in denen bei Änderungen der Drehzahl eine konstante Spannung des Materials erforderlich ist, um ein Reißen desselben zu vermeiden. Eine weitere Möglichkeit liegt im Einsatz als BREMSE IM GEGENFELD bis ca. zur Hälfte der Synchrongeschwindigkeit. Hinsichtlich Sonderanwendungen sollten Sie sich an unsere technische Abteilung wenden.

**Spezial- und Einphasen-Schlupfmotoren**

Auf Anfrage sind wir in der Lage, Spezial- und Einphasen-Schlupfmotoren in verschiedenen Bauformen und Polanzahlen mit kundenspezifischem Anlaufdrehmoment herzustellen.

**Einstellung des Anlaufdrehmoments**

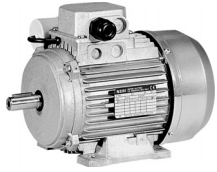
Um den Wert des verfügbaren Anlaufdrehmoments je nach Typ oder zu verarbeitendem Material einzustellen, werden Spannungsregler eingesetzt, die das Anlaufdrehmoment als quadratische Funktion der an den Klemmen angelegten Spannung regulieren. Die Einstellung der Spannung kann über elektronische oder mechanische Vorrichtungen erfolgen, die die Spannung auf dem Leiter erfassen und das vom Motor erzeugte Anlaufdrehmoment entsprechend regulieren. Dabei wird ein System mit Rückkopplung im geschlossenen Kreislauf gebildet.

## MOTORI MONOFASE / SINGLE-PHASE MOTORS / EINPHASENMOTOREN

## Motori monofase

## Single-phase motors

## Einphasenmotoren



Serie / Series/ Serie

**M - MA  
MD - MDA**Grand. / Size / Größe  
50...100

Designazione

Caratteristiche meccaniche

Caratteristiche elettriche

Collegamenti morsetteria

Opzioni

Freno

Dati tecnici

Dimensioni

Designation

Mechanical characteristics

Electrical characteristics

Terminal board connections

Options

Brake

Technical specifications

Dimensions

Tipenschlüssel

Mechanische Ausführung

Elektrische Ausführung

Klemmenanschlüsse

Optionen

Bremsen

Technische Daten

Abmessungen

A12

A16

A26

A29

A31

A37

A68

A76

I motori asincroni sono con rotore a gabbia di scoiattolo pressofusa, statore avvolto, chiusi, ventilati esternamente secondo IEC 34-6.

*The induction motors we produce have die-cast squirrel cage motor and wound stator, are enclosed and have external cooling to IEC 34-6.*

Alle unsere Asynchronmotoren haben einen druckgegossenen Käfigläufer, gewickelten Stator und sind geschlossen und außenbelüftet nach IEC 34-6.

**MD - MDA**

Motori ad alto contenuto tecnologico derivati dalla nostra esclusiva esperienza e tecnologia.

Si ottengono elevate potenze rese, ridotte di un 30% rispetto i motori standard da catalogo, a parità di tutte le altre condizioni.

In alcuni casi, utilizzando un solo condensatore per le due velocità, con conseguente semplificazione circuitale. Silenziosi, affidabili, di elevate prestazioni, sono una ulteriore evoluzione del motore monofase, hanno correnti di spunto in % e coppie motrici di avviamento %, simili ai motori standard.

**MD - MDA**

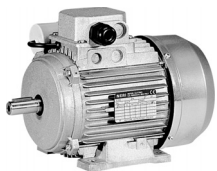
*High-technology motors resulting from our own exclusive experience and technology. High power outputs, 30% lower than standard catalogue motors, all other conditions being equal. In some cases a single capacitor is used for both speeds, providing simpler circuitry.*

*Quiet, reliable, high performance, they represent an evolutionary step for the single-phase motor. They have % starting currents and starting drive torque % similar to standard motors.*

**MD - MDA**

Es handelt sich dabei um hochtechnologische Spezialmotoren, die aus unserer exklusiven Erfahrung und Technologie entstanden sind, die ausschließlich dank unserer Erfahrung und unserer technologischen Kenntnisse entworfen und gebaut werden konnten.

Mit diesen Motoren können hohe Betriebleistungen erzielt werden, die bei Gleichheit aller übrigen Bedingungen um ca. 30% niedriger sind als bei unseren Standardmotoren. Es besteht die Möglichkeit, um den Schaltkreis zu vereinfachen, nur einem Kondensator für zwei Geschwindigkeiten einzusetzen. Es handelt sich um geräuscharme und zuverlässige Motoren mit hoher Leistung, die als Weiterentwicklung des herkömmlichen Einphasenmotors mit ähnlichen Anlaufströmen und Anlaufmomenten, angesehen werden können.

**Monofase doppia tensione e doppia frequenza****Single-phase, dual voltage and dual frequency motors****Einphasenmotoren Spannungs-und Frequenzumschaltbar**

Serie / Series/ Serie

**MF  
MFA**Grand. / Size / Größe  
50...100

Designazione

Caratteristiche meccaniche

Caratteristiche elettriche

Collegamenti morsetteria

Opzioni

Freno

Dati tecnici

Dimensioni

Designation

Mechanical characteristics

Electrical characteristics

Terminal board connections

Options

Brake

Technical specifications

Dimensions

Tipenschlüssel

Mechanische Ausführung

Elektrische Ausführung

Klemmenanschlüsse

Optionen

Bremsen

Technische Daten

Abmessungen

A12

A16

A26

A29

A31

A37

A70

A76

Sono motori realizzati con un avvolgimento speciale. Si ottiene un funzionamento con un solo condensatore per le due tensioni e le due frequenze. (esempio 115V/230V-50Hz/60Hz). È possibile l'inversione del senso di rotazione del motore con semplici collegamenti in morsetteria. Le potenze rese all'albero [W], e le prestazioni in generale sono paragonabili, ai motori SERIE M a pari grandezza di macchina.

*They are motors produced with a special winding, they work with a single capacitor for double voltage and frequency (example 115V/230V -50 Hz/60 Hz). You can reverse the rotation of the motor with simple connections in the terminal box. Referring to the power given to the shaft (W) and the general performance of the motors, they can be compared to M series.*

Es handelt sich hier um Motoren mit einer Spezialwicklung. Mit nur einem Betriebskondensator kann der Motor mit zwei Spannungen und zwei Frequenzen betrieben werden (Beisp.: 115V/230V-50Hz/60Hz). Durch einfache Verbindungen am Klemmbrett ist die Umschaltung der Drehrichtung möglich. Die an die Welle abgegebene Leistung [W] und die Leistungen im allgemeinen sind bei gleicher Baugröße mit den Motoren der Serie M.

## MOTORI MONOFASE / SINGLE-PHASE MOTORS / EINPHASENMOTOREN

**Motori monofase ad alta coppia di spunto**

Sono motori provvisti di dispositivi che hanno lo scopo di connettere, in parallelo al condensatore di marcia, un condensatore di spunto che, una volta avviato il motore, viene disinserito automaticamente rilevando diverse grandezze in funzione del dispositivo utilizzato.

Le coppie motrici ottenibili allo spunto [Nm], sono paragonabili a quelle di un motore trifase equivalente.

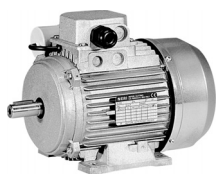
**Single-phase motors with high starting torque**

*These are motors with devices for the purpose of connecting a starting capacitor in parallel with the run capacitor, which is shut off automatically once the motor is started and measures various parameters based on the device in question.*

*The drive torque that may be achieved during starting [Nm] is comparable to that of an equivalent three-phase motor.*

**Wechselstrommotoren mit hohem Anlaufmoment**

Es handelt sich um Motoren, die über Vorrichtungen für die Parallelschaltung des Anlaufkondensators mit dem Betriebskondensator verfügen. Sobald der Motor läuft wird der Anlaufkondensator automatisch ausgeschaltet und unterliegt der Steuerung der eingesetzten Vorrichtung. Das erreichbare Anlaufmoment [Nm] entspricht dem vergleichbarer Drehstrommotoren.

**Motori monofase con disgiuntore centrifugo**

Serie / Series/ Serie  
**MC**  
Grand. / Size / Größe  
50...100

**Centrifugal circuit breaker**

Designazione	<i>Designation</i>
Caratteristiche meccaniche	<i>Mechanical characteristics</i>
Caratteristiche elettriche	<i>Electrical characteristics</i>
Collegamenti morsettiera	<i>Terminal board connections</i>
Opzioni	<i>Options</i>
Freno	<i>Brake</i>
Dati tecnici	<i>Technical specifications</i>
Dimensioni	<i>Dimensions</i>

**Fliehkraftschalter**

È un dispositivo molto stabile in quanto rileva i giri al minuto del motore. È composto da una parte rotante calettata sull'albero motore, da una parte elettrica debitamente isolata, calettata sullo scudo posteriore al motore e da una calotta in alluminio di protezione meccanica, con guarnizioni di tenuta, che assicurano una protezione IP 55 all'insieme. La protezione completa del motore con disgiuntore centrifugo in IP 55 tramite calotta in alluminio (fornibile a richiesta).

Senza calotta di protezione (standard):

- disgiuntore IP20
- motore IP55.

**A richiesta disgiuntore interno al motore.**

Questo dispositivo ha un contatto normalmente chiuso tramite molla; quando il motore inizia a girare, la forza centrifuga, agendo su due masse rotanti sull'albero, esercita una forza che raggiunto il numero di giri nominali vince l'opposizione della molla aprendo il contatto e sconnettendo il condensatore di spunto servito per ottenere l'alta coppia motrice di avviamento.

È omologabile secondo norme UL o CSA (a richiesta).

*This is a highly stable device, as it detects the rpm of the motor. It consists of a rotary part keyed to the motor shaft, a duly insulated electrical part keyed to the rear motor shield, and an aluminum cap for mechanical protection, with sealing gaskets that ensure an IP 55 rating for the unit.*

*Only STM can offer complete motor protection with centrifugal circuit breaker at IP 55 through an aluminum cap (on request). Without protection cap. (standard)*  
- Centrifugal switch IP20  
- Motor IP55.

**Upon request internal centrifugal circuit breaker.**

*This device has a normally closed spring-loaded contact. When the motor begins to turn, the centrifugal force acts on two masses rotating on the shaft and exerts a force that overcomes the opposition of the spring once the rated rpm is reached.*

*This opens the contact and disconnects the starting capacitor used to achieve the high starting drive torque.*

*It may be approved by UL and CSA standards. (on request).*

Es handelt sich um eine Vorrichtung die ununterbrochen eingeschaltet ist, da sie die Motordrehzahl erfaßt. Der Fliehkraftschalter besteht aus einem Drehteil, das an der Motorwelle befestigt ist, aus einem entsprechend rechenisolierten elektrischen Teil, das am hinteren Lagerschild angebracht ist, und aus einer Schutzhaube aus Aluminium mit Dichtungen in der Schutzart IP55. Der komplette Schutz des Motors durch einen Fliehkraftschalter mit Aluhaube in der Schutzart IP55 ist ein Exklusivprodukt der STM (auf Anfrage). Ohne Schutzkalotte (standard):

- Abschalter IP20
- Motor IP55.

**Auf Anfrage eingebauter Fliehkraftschalter am Motor.**

Diese Vorrichtung hat einen normalerweise von einer Feder geschlossenen Kontakt. Wenn sich der Motor in Betrieb setzt, überwindet die Fliehkraft - mit Hilfe von zwei Drehgewichten an der Welle - beim Erreichen der Nenndrehzahl die Kraft der Feder und öffnet den Kontakt, wobei der zum Erreichen des hohen Anzugsmoments dienende Anlaufkondensator ausgeschaltet wird. Der Fliehkraftschalter kann nach UL oder CSA zugelassen werden (auf Anfrage).

## MOTORI MONOFASE / SINGLE-PHASE MOTORS / EINPHASENMOTOREN

Motori monofase con Relè  
amperometrico (Klixon)Single-phase motor with Ampere  
relay (Klixon)Einphasenmotoren mit Stromrelais  
(Klixon)

Serie / Series/ Serie	Designazione	Designation	Typenschlüssel	A12
<b>MR</b> <b>MRA</b>	Caratteristiche meccaniche	Mechanical characteristics	Mechanische Ausführung	A16
	Caratteristiche elettriche	Electrical characteristics	Elektrische Ausführung	A26
Grand. / Size / Größe 50...100	Collegamenti morsetteria	Terminal board connections	Klemmenanschlüsse	A29
	Opzioni	Options	Optionen	A31
	Freno	Brake	Bremse	A37
	Dati tecnici	Technical specifications	Technische Daten	A68
	Dimensioni	Dimensions	Abmessungen	A76

È un relay amperometrico, il quale quando la corrente allo spunto è elevata, agendo tramite una bobina e un'ancora mobile con contatto elettrico, vince la forza di una molla antagonista, connettendo in parallelo al condensatore di marcia quello di avviamento.

Nel momento in cui il motore si è avviato, la corrente assorbita cala e la molla antagonista questa volta è in grado di vincere la forza elettromagnetica della bobina per cui disconnette il condensatore di spunto.

Tale dispositivo è disponibile in varie portate amperometriche, ed è omologato secondo norme UL e CSA.

*This is an ampere relay which overcomes the force of an antagonist spring when the starting torque is high, working through a coil and mobile armature with electrical contact, to connect the starting capacitor parallel to the run capacitor.*

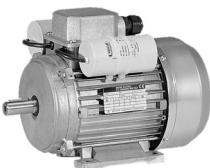
*When the motor has started the absorbed current drops and the antagonist spring is then able to overcome the electromagnetic force of the coil, thereby disconnecting the starting capacitor.*

*This device is available in various ampere capacities and is approved per UL and CSA standards.*

Es handelt sich dabei um ein amperometricches Relais. Wenn der Anlaufstrom hoch ist, überwindet dieses Relais durch eine Spule und einen beweglichen Anker mit Schaltkontakt die Kraft einer Gegenfeder und schaltet den Anlaufkondensator und den Betriebskondensator parallel.

Sobald der Motor läuft, vermindert sich die Stromaufnahme, und die Gegenfeder überwindet die elektromagnetische Kraft der Spule und schaltet den Anlaufkondensator aus.

Diese Vorrichtung, die über eine UL- bzw. CSA-Zulassung verfügt, ist für unterschiedliche Amperwerte lieferbar.

Motori monofase con condensatore  
elettronicoSingle/phase induction motors with  
electronic capacitorAsynchronmotoren mit  
elektronischem Kondensator und

Serie / Series/ Serie	Designazione	Designation	Typenschlüssel	A12
<b>ME</b> <b>MEA</b>	Caratteristiche meccaniche	Mechanical characteristics	Mechanische Ausführung	A16
	Caratteristiche elettriche	Electrical characteristics	Elektrische Ausführung	A26
Grand. / Size / Größe 50...100	Collegamenti morsetteria	Terminal board connections	Klemmenanschlüsse	A29
	Opzioni	Options	Optionen	A31
	Freno	Brake	Bremse	A37
	Dati tecnici	Technical specifications	Technische Daten	A68
	Dimensioni	Dimensions	Abmessungen	A76

Motori asincroni monofase con  
condensatore elettronicoSingle/phase induction motors with  
electronic capacitorAsynchronmotoren mit  
elektronischem Kondensator und  
hohem Anlaufmoment

È un dispositivo elettronico temporizzato integrato nell'involucro di un condensatore a carta impregnata.

Questo dispositivo, al momento dell'alimentazione del motore, quando il condensatore di spunto è in parallelo a quello di marcia, fa partire un timer che dopo un certo periodo di tempo disconnette il condensatore di spunto stesso, ottenendo così l'alta coppia di spunto, consente cicli start-stop ogni 3 secondi.

*This is a timed electronic device built into the housing of an impregnated-paper capacitor.*

*This device starts a timer when the motor is powered, when the starting capacitor is parallel to the run capacitor; after a certain period of time, the timer disconnects the starting capacitor to achieve a high starting torque, allowing start-stop cycles every 3 seconds.*

Es handelt sich um eine zeitgesteuerte, elektronische Vorrichtung, die sich in der Hülle eines Kondensators aus imprägniertem Papier befindet.

Sobald der Motor mit Strom versorgt wird und wenn der Anlaufkondensator parallel zum Betriebskondensator geschaltet ist, schaltet diese Vorrichtung einen Timer ein, der nach Ablauf einer bestimmten Zeit den Anlaufkondensator ausschaltet. Auf diese Weise wird ein hohes Anlaufmoment erreicht. Der Ein- und Ausschaltvorgang kann in Abständen von 3 Sekunden erfolgen.

## 1.2 DESIGNAZIONE

## 1.2 DESIGNATION

## 1.2 BEZEICHNUNGEN

Descrizione Description Beschreibung	T	63	A	4	B5	—	55	F	FA	M	LS1
	Tipo Type Typ	Grandezza Size Größe	Lunghezza Length Länge	n° poli Pole n. Polzahl	[*1]	[*2]	[*3]	[*4]	[*5]	[*6]	[*7]
<b>MOTORI TRIFASE / THREE-PHASE MOTORS / DREHSTROMMOTOREN</b>											
Trifase Three-phase Drehstrom	T	50...160		2							
Trifase autofrenante Self braking three-phase Drehstrom, Bremsmotor	TA			4 6 8 12							
Alta Efficienza High efficiency Mit hohem Wirkungsgrad	H	56...160		2-4							
Alta Efficienza autofrenante Self braking high efficiency Mit hohem Wirkungsgrad, Bremsmotor	HA										
Per Inverter For inverter Für Inverter	I	50...160		2-4-6							
Per Inverter autofrenante For self braking inverter Für Inverter, Bremsmotor	IA										
Trifase doppia polarità Dual polarity three-phase Drehstrom, polumschaltbar	D	56...160	A ... ML	2/4	*B35 (B3/B5) *B34 (B3/B14) B3L4 B3L2	— A B	54 55 56	F H	FA	M	
Trifase doppia polarità autofrenante Self braking dual polarity three-phase Drehstrom, polumschaltbar, Bremsmotor	DA			4/8 4/6 6/8 2/6 2/8 2/12							
a Scorrimento Slip Schlupf	S	71...132		4-6-8							
a Scorrimento autofrenante Self braking slip Schlupf, Bremsmotor	SA										
a Riluttanza Reluctance Reluktanz	R	63...160		2-4-6							
a Riluttanza autofrenante Self braking reluctance Reluktanz, Bremsmotor	RA										
<b>MOTORI MONOFASE / SINGLE-PHASE MOTORS / EINPHASENMOTOREN</b>											
Monofase Single-phase Einphasen	M	50...100	A ... ML	2-4-6	5 B14 *B3 *B35 (B3/B5) *B34 (B3/B14) B3L4 B3L2	—  (Vedi tabelle) (See tables) (Siehe Tabellen)	54 55 56	F H	FA	M	
Monofase autofrenante Self braking single-phase Einphasen, Bremsmotor	MA										
Monofase doppia polarità Dual polarity single-phase Einphasen, polumschaltbar	MD										
Monofase doppia polarità autofrenante Self braking dual polarity single-phase Einphasen, polumschaltbar, Bremsmotor	MDA										
Doppia tensione doppia frequenza Dual frequency dual voltage Spannungs- und frequenzumschaltbar	MF										
Doppia tensione doppia frequenza autofrenante Self braking dual frequency dual voltage Spannungs- und frequenzumschaltbar, Bremsmotor	MFA										
Con disgiuntore centrifugo With centrifugal circuit breaker Mit Fliehkraftschalter	MC										
Con relè amperometrico With ampere relay Mit Stromrelais	MR										
Con relè amperometrico autofrenante With self braking ampere relay Mit Stromrelais, Bremsmotor	MRA										
Con condensatore elettronico With electronic capacitor Mit elektronischem Kondensator	ME										
Con condensatore elettronico autofrenante With self braking electronic capacitor Mit elektronischem Kondensator, Bremsmotor	MEA										

**[\*1] Forma** (pag. A16)

Specificare attacchi ridotti.  
Se attacchi ridotti IEC: ES. 71 B5.  
Se solo albero o flangia specificare dimensioni : Es. 160/11.

Nelle forme costruttive con piede, la scatola morsettiera può essere orientata in tre posizioni.

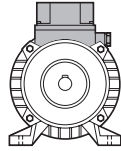
**[\*1] Design version** (page A16)

Specify adapted connections  
If IEC adapted connections: e.g. 71 B5.  
If just shaft or flange specify dimensions. e.g.: 160/11.

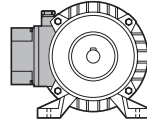
On design versions with feet, the terminal box can be set in three positions.

**[\*1] Bauform** (S. A16)

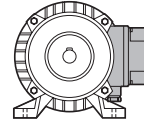
Verkleinerte Befestigungen angeben  
Wenn verkleinerte Befestigungen IEC:ES.71 B5.  
Wenn nur Welle oder Flansch Maße angeben z.B.: 160/11.  
Bei den Bauformen mit Fuß kann der Klemmenkasten in drei Positionen ausgerichtet werden.



**B3**  
standard



**B3L4**



**B3L2**

**[\*2] Tensione e frequenza** (pag. A27)

Specificare tensione STD o a richiesta

**[\*2] Voltage and frequency** (page A27)

Specify STD voltage or upon request

**[\*2] Spannung und Frequenz** (S. A27)

Spannung STD oder auf Wunsch angeben

**[\*3] Grado di protezione**

**[\*3] Protection level**

**[\*3] Schutzart**

T-D-H-I-R-S-M-MD-MF	IP54	IP55	IP56	IP65
Indicazione designazione Designation indication Bezeichnung	<b>54</b>	Standard	<b>56</b>	<b>65</b>

TA-DA-HA-IA-RA-SA-MA-MDA-MFA	Freno Brake Bremsen	IP54	IP55	IP56	IP65
	Indicazione designazione Designation indication Bezeichnung	FA	Standard		
	FD	Standard			
	FS	Standard			
	FP	Standard			
		<b>54</b>	<b>55</b>	<b>56</b>	<b>65</b>

A richiesta  
On request  
Auf anfrage

**[\*4] Classe di isolamento** (pag. A26)

**[\*4] Insulation class** (page A26)

**[\*4] Isolierstoffklasse** (S. A26)

Indicazione designazione Designation indication Bezeichnung	CL F Standard	CL H
		<b>F</b>

**[\*5] Tipo di freno**

**[\*5] Type of brake**

**[\*5] Bremsentyp**

Freni disponibili	Brakes available	Lieferbare Bremsen		Pag./ Page / Seite
Freno in C.A.	AC brake	Wechselstrombremse	<b>FA</b>	42
Freno in C.C.	DC brake	Gleichstrombremse	<b>FD</b>	44
Freno di stazionamento	Parking brake	Haltebremse	<b>FS</b>	46
Freno ad azione positiva	Positive action brake	Arbeitsstrombremse	<b>FP</b>	48

**[\*6] Freno maggiorato** (pag. A43-A45)  
**M** – Disponibile solo sui freni FA e FD

**[\*6] Increased brake** (page A43-A45)  
**M** – Only available on FA and FD brakes

**[\*6] Vergrößerte Bremse** (S. A43-A45)  
**M** – Nur für die Bremsen FA und FD erhältlich

**[\*7] Opzioni**  
Indicare il simbolo della opzione che si desidera.  
Dettaglio opzioni a pag. A14.

**[\*7] Options**  
State the symbol for the option required.  
Option details on page A14.

**[\*7] Optionen**  
Das Symbol der gewünschten Option angeben.  
Optionen siehe S. A14

Tipo opzione / Option type / Option		Applicabilità / Applicability / Anwendbarkeit		Descrizione / Description / Beschreibung	Note	Pag.
		trifase / three-phase Drehstrommotoren 50..160	monofase / single-phase Einphasenmotoren 50..160			
Alimentazione separata <i>Separate voltage supply</i> Separate Stromversorgung	..SA			Freno ad alimentazione separata A.C. <i>Brake with separate AC voltage supply</i> Bremsse mit separater Wechselstromversorgung	1)	39
	..SD			Freno ad alimentazione separata D.C. <i>Brake with separate DC voltage supply</i> Bremsse mit separater Gleichstromversorgung		39
Leva di sblocco <i>Release lever</i> Entsperrhebel	LS..			Posizione leva di sblocco <i>Release lever position</i> Position des Entsperrhebels	2)	38
Avviamento e frenata progressivi <i>Progressive starting and braking</i> Anlauf- und bremsverzögert	PR				3)	39
Servoventilazione <i>Power cooling</i> Servobelüftung	VF			Servoventilato monofase <i>Single-phase power cooled</i> Servobelüftet Einphasen	4)	32
	VT			Servoventilato trifase <i>Three-phase power cooled</i> Servobelüftet Drehstrom	5)	32
Albero bisporgente <i>Double ended shaft</i> Zweiseitige Welle	BI				6)	35
Protezioni termiche <i>Thermal overload cut-out switches</i> Überhitzungsschutz	TO			Protezione termica PTO <i>PTO thermal overload cut-out switch</i> PTO-Überhitzungsschutz		35
	TC			Protezione termica PTC <i>PTC thermal overload cut-out switch</i> PTC-Überhitzungsschutz		35
	3TO			3 Protezioni termiche PTO (standard) <i>3 PTO thermal overload cut-out switches (standard)</i> PTO-Überhitzungsschutz 3 Stück (Standard)		—
	3TC			3 Protezioni termiche PTC <i>3 PTC thermal overload cut-out switches</i> PTC-Überhitzungsschutz 3 Stück		—
Protezione umidità <i>Damp protection</i> Feuchtigkeitsschutz	TR			Tropicalizzato <i>Tropicalized</i> Tropenfest		31
Interruttore <i>Switch</i> Schalter	IT			Interruttore semirotativo <i>Semi-rotary switch</i> PTC-Überhitzungsschutz 3 Stück	7)	—
	IV			Invertitore semirotativo <i>Semi-rotary inverter</i> Umkehrschalter 180°-Drehbereich		—
Normative estere <i>Foreign standards</i> Ausländische Normen	UR			cRSus (Normative americane) <i>cRSus (American standards)</i> cRSus (Amerikanische Normen)		—
Ventole <i>Fans</i> Lüfterräder	VM			Ventola in metallo <i>Metal fans</i> Lüfterrad aus Metall		32
	SV			Senza ventola <i>No fan</i> Ohne Lüfterrad		32
Tettuccio parapioggia <i>Rain shield</i> Regenschutzdach	PP				8)	36
Scarico condensa <i>Condensation drainage</i> Kondenswasserablauf	FC			Foro scarico condensa <i>Condensation drainage hole</i> Kondenswasserablaufloch		31
Scaldiglie anticondensa <i>Anti-condensation heaters</i> Wicklungsheizung	SC					31
Doppia morsettiera <i>Double terminal board</i> Doppelte Klemmenleisten	DM				8b)	—
Encoder	EN					34
Motore per alte temperature <i>Motor for high temperatures</i> Motor für hohe Temperaturbereiche	T			Con anelli tenuta Viton e parti metalliche <i>With Viton retention rings and metal parts</i> Mit Viton-Dichtungsringen und Metallteilen		—
Doppio avvolgimento <i>Double winding</i> Doppellagige Wicklung	DA				9)	—
Condensatore MF <i>MF Capacitor</i> Kondensator MF	C..					—
Avvolgimento equilibrato <i>Balanced winding</i> Ausgewuchtete Wicklung	AE					36
Tipo di servizio <i>Type of duty</i> Betriebsart	S					21



<p><b>Note:</b></p> <p>1) Se non viene indicato niente si intende il valore di tensione riportato a catalogo. Altrimenti riportare il valore della tensione di alimentazione ( esempio: 24SD per 24 V in D.C.).</p> <p>2) Opzione non disponibile sui freni tipo : FS; FP</p> <p>3) Ventola in ghisa (o volano, nei motori autofrenanti)</p> <p>4) Opzione non disponibile: BI</p> <p>5) Opzione non disponibile: BI Alimentazione separata Standard Non disponibile IEC: 50, 56, 63, 71</p> <p>6) Opzioni non disponibili: PP, VF, VT</p> <p>7) Solo su trifase e monofase standard</p> <p>8) Opzione non disponibile: BI</p> <p>8b) Vedi tabella morsettiere a pag. A30</p> <p>9) Opzione non disponibile: Motori doppia polarità con polarità doppia (esempio: 2/4; 4/8 ecc.)</p>	<p><b>Note:</b></p> <p>1) <i>If nothing is indicated the voltage shown in the catalogue applies. Otherwise indicate the voltage supply (e.g.: 24SD for 24 V in DC)</i></p> <p>2) <i>Option not available of brake types: FS, FP</i></p> <p>3) <i>Cast iron fan (or flywheel, on self braking motors)</i></p> <p>4) <i>Option not available: BI</i></p> <p>5) <i>Option not available: BI. Standard separate power supply. Not available IEC: 50, 56, 63, 71.</i></p> <p>6) <i>Option not available: PP, VF, VT</i></p> <p>7) <i>Only on standard single-phase and three-phase</i></p> <p>8) <i>Option not available: BI</i></p> <p>8b) <i>See terminal board table on page A30</i></p> <p>9) <i>Option not available. Dual polarity motors with dual polarity (e.g.: 2/4, 4/8, etc.)</i></p>	<p><b>Anmerkungen:</b></p> <p>1) Sofern nicht anderweitig angegeben, gilt der Spannungswert aus dem Katalog. Andernfalls den Wert der Versorgungsspannung angeben (Beispiel: 24SD für 24 V Gleichstrom)</p> <p>2) Option nicht erhältlich für Bremsen vom Typ: FS, FP</p> <p>3) Lüfterrad aus Gusseisen (oder Schwungrad bei Bremsmotoren)</p> <p>4) Option nicht erhältlich: BI</p> <p>5) Option nicht erhältlich: BI. Separate Standardversorgung. Nicht erhältlich IEC: 50, 56, 63, 71</p> <p>6) Option nicht erhältlich: PP, VF, VT</p> <p>7) Nur für Drehstrom und Einphasen in Standardausführung</p> <p>8) Option nicht erhältlich: BI</p> <p>8b) Siehe Klemmenanschlusstabelle S. A 30</p> <p>9) Option nicht erhältlich. Polumschaltbare Motoren mit zwei Polungen (Beispiel: 2/4, 4/8, etc.)</p>
--	--	--

Esempio / Example / Beispiel **		
<b>LS1</b>	<b>VF</b>	<b>3TO</b>

\*\* Motore con leva di sblocco in posizione 1, servoventilazione e 3 protezioni PTO

\*\* *Motor with release lever in position 1, power cooling and 3 PTO overload switches*

\*\* Motor mit Entsperrhebel in Position 1, Servobelüftung und 3 Stück PTO-Überhitzungsschutz



**1.3 CARATTERISTICHE MECCANICHE**

**Forme costruttive**

Nella tabella seguente sono riportate le forme costruttive dei motori e le posizioni di montaggio secondo IEC 34-7. Versioni B3, B5, B14.

**1.3 CHARACTERISTICS**

**Available configurations**

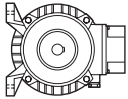
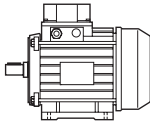
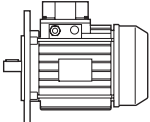
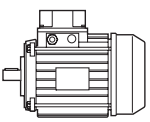
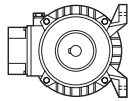
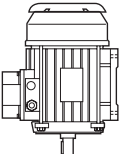
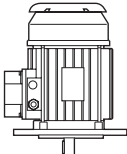
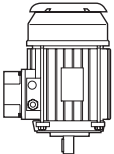
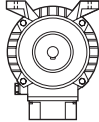
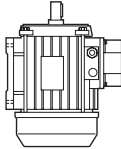
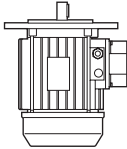
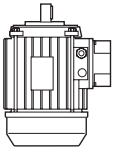
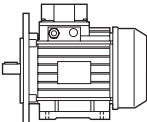
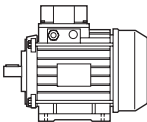
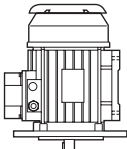
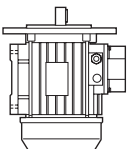
*Available configurations Table shows the available motor configurations and installation positions per IEC 34-7. Versions B3, B5, B14.*

**1.3 DREHMOMENTMERKMALE**

**Bauformen**

Bauformen In der Tabelle sind die Bauformen der Motoren und die Einbaupositionen nach IEC 34-7 aufgeführt. Ausführungen: B3, B5, B14.

Tab. 1.1

<b>Motori con piedi B3</b> <i>Motors with feet B3</i> Motoren mit Füßen B3		<b>Motori con Flangia B5</b> <i>Flange-mounted motors B5</i> Motoren mit Flansch B5		<b>Motori con Flangia B14</b> <i>Flange-mounted motors B14</i> Motoren mit Flansch B14			
IM 1051 (IM B6) 	IM 1001 (IM B3) 	IM 3001 (IM B5) 	IM 3601 (IM B14) 				
IM 1061 (IM B7) 	IM 1011 (IM V5) 	IM 3031 (IM V1) 	IM 3631 (IM V18) 				
IM 1071 (IM B8) 	IM 1031 (IM V6) 	IM 3031 (IM V3) 	IM 3631 (IM V19) 				
IM 2001 (IM B35) 	IM 2101 (IM B34) 	IM 2011 (IM V15) 	IM 2031 (IM V36) 				
B3/B5		B3/B14		V3/V5		V3/V6	

I motori riportano in targa (salvo diversa indicazione) la forma costruttiva base ma possono essere installati nelle forme derivate come indicato nella tabella seguente:

*The plates on the motors show (unless otherwise indicated) the basic design version but can be installed in the derived design versions as indicated in the following table:*

Die Motoren weisen auf dem Typenschild (sofern nicht anderweitig angegeben) die Grundbauform auf, sie können jedoch in den abgeleiteten Formen gemäß der nachstehenden Tabelle installiert werden:

Tab. 1.2

<b>Forma costruttiva base</b> <i>Basic design version</i> Grundbauform	<b>Forma costruttiva derivata</b> <i>Derived design version</i> Andere Einbaulagen				
<b>IM B3</b>	IM B6	IM B7	IM B8	IM V5	IM V6
<b>IM B5</b>	IM V1	IM V3			
<b>IM B14</b>	IM V18	IM V19			

**Carcassa (secondo CEI-IEC 72-1)**

È in alluminio pressofuso, ad elevata capacità meccanica, con buona conducibilità termica, ed elevata leggerezza. È disponibile in versione con tiranti standard e a richiesta con borchie.

**Frame (per CEI-IEC 72-1)**

*Die-cast aluminum with high mechanical capacity, good thermal conductivity, and very lightweight. Frames are available in a version with standard tie-rods, with studs upon request.*

**Gehäuse (nach CEI-IEC 72-1)**

Das Motorgehäuse ist Aluminium-Druckguß mit hoher Widerstandsfähigkeit, guter Wärmeleitfähigkeit und geringem Gewicht. Das Gehäuse ist als Ausführung mit Standard-Zugstangen oder auf Wunsch mit Nieten lieferbar.

I **cuscinetti** da noi utilizzati sono ad una corona di sfere radiali, precaricati, di marche primarie.

I motori sono costruiti per un servizio S1 standard, altre esecuzioni a richiesta.

We use preloaded radial **ball bearing rings of the best makes, which our company considers reliable.**

*Motors are manufactured for standard S1 service, other executions on request..*

Die von uns eingesetzten Lager sind vorgespannte einreihige **Radialkugellager** eines erstrangigen Lieferanten, die wir für zuverlässig halten. Die Motoren sind für die Betriebsart S1 Standard ausgelegt. Andere Ausführungen auf Anfrage.

## Cuscinetti

Tab.1.3

Grandezza / Size / Baugröße	50	56	63	71	80	90	100	112	132	160
Lato comando / Front / Vorne	6000-ZZ	6201-ZZ	6202-ZZ	6203-ZZ	6204-ZZ	6205-ZZ	6206-ZZ	6206-ZZ	6308-ZZ	6309-ZZ
* Lato opposto comando / Back / Hinten	6000-ZZ	6201-ZZ	6202-ZZ	6203-ZZ	6204-ZZ	6205-ZZ	6206-ZZ	6206-ZZ	6308-ZZ	6309-ZZ

\* 2RS a richiesta / \* 2RS upon request / \* 2RS auf Anfrage

Sono del tipo ZZ anteriormente e posteriormente (2RS stagni a richiesta), con due schermi metallici, e prelubrificati con grasso al litio con range di temperature da -10 °C a +110 °C.

Possono essere applicati cuscinetti stagni anteriori, cuscinetti a gioco maggiorato C3 o con grasso speciale per alte temperature (-30 °C a +140 °C) - grassi sintetici.

Sono tutti precaricati, tramite anelli ondulati in acciaio temprato, per eliminare i giochi residui del cuscinetto.

*Bearings are type ZZ front and back ( 2RS upon request), with two metal screens, pre-lubricated with lithium grease with a temperature range from -10° C till +110° C. Waterproof front bearings, C3 bearings with increased clearance, or bearings with special grease for high temperatures (-30 °C to +140 °C)/synthetic grease may be applied. All are pre-loaded with corrugated tempered steel rings to eliminate residual clearance from the bearing.*

Vorn und hinten vom Typ ZZ (abgedichtete 2RS-Lager auf Anfrage), ausgestattet mit zwei metallenen Schutzkappen, vorgeschmiert mit Lithiumfett und geeignet für den Temperaturbereich von -10° C bis +110° C.

Auf Wunsch sind geschlossene Vorderlager, Lager mit größerem Spiel (C3) oder mit Spezialfett für extreme Temperaturbereiche von -30° C bis +140° C (synthetische Fette) lieferbar. Alle Lager sind durch Ausgleichsringe aus gehärtetem Stahl axial vorgespannt, um eventuell noch vorhandenes Spiel zu beseitigen.

**Gli alberi motore** e le linguette di serie sono conformi, per quanto riguarda dimensioni e tolleranze, alle CEI IEC 72-1.

Gli alberi di serie sono costruiti con acciaio C43.

*As standard, the drive shafts and tangs have dimensions and tolerances to CEI IEC 72-1.*

*Standard shafts are constructed in C43 steel.*

Die serienmäßigen **Antriebswellen** und Federkeile entsprechen in den Abmessungen und der Toleranz der Norm CEI IEC 72-1. Die serienmäßigen Wellen sind aus C43-Stahl hergestellt, Motorengehäuse.

## Tolleranze geometriche

Nella tabella seguente sono riportate le tolleranze meccaniche dal lato comando.

## Geometric tolerances

*The table below shows the mechanical tolerances of the control side.*

## Geometrische Toleranzen

In der nachstehenden Tabelle sind die mechanischen Toleranzen auf der Frontseite angegeben.

Tab.1.4

Descrizione Description Beschreibung	Dimensioni Dimensions Abmessungen	Tolleranza Tolerance Toleranz
Diametro albero Shaft diameter Wellendurchmesser	<b>D</b> Ø 9 ÷ 28 Ø 32 ÷ 48 Ø 55 ÷ 110	<b>j6</b> <b>k6</b> <b>m6</b>
Linguetta CEI IEC 72-1 CEI IEC 72-1 Standardized keys Nach CEI IEC 72-1 genormte Paßfedern	<b>F</b>	<b>h9</b>
	<b>GA</b> 2 ÷ 6 7 ÷ 16	<b>h9</b> <b>h11</b>
Flange unificate CEI IEC 72-1 CEI IEC 72-1 Standardized flanges Nach CEI IEC 72-1 genormte Flansche	<b>N</b> Ø ≤ 450	<b>j6</b>
Alltezza d'asse secondo CEI IEC 72-1 Axis height per CEI IEC 72-1 Achsenhöhe nach CEI IEC 72-1	<b>H</b>	<b>+0 ÷ -0.5</b>
Battuta albero Shaft stop Wellenansatz	<b>E - EA</b>	<b>+0 ÷ -0.2</b>

**Flange e scudi (secondo CEI IEC 72-1)**

Sono in lega di alluminio pressofuso, di dimensioni unificate secondo CEI IEC 72-1, su disegno del cliente, ridotte o maggiorate. Nella grandezza 160 le flange B5 e B14 sono in ghisa.

**Flanges and shields (per CEI-IEC 72-1)**

These are made of die-cast aluminum alloy, with standard dimensions per CEI-IEC 72-1 or based on customer drawings, reduced or enlarged.

On 160 sizes the B5 and B14 flanges are in cast iron.

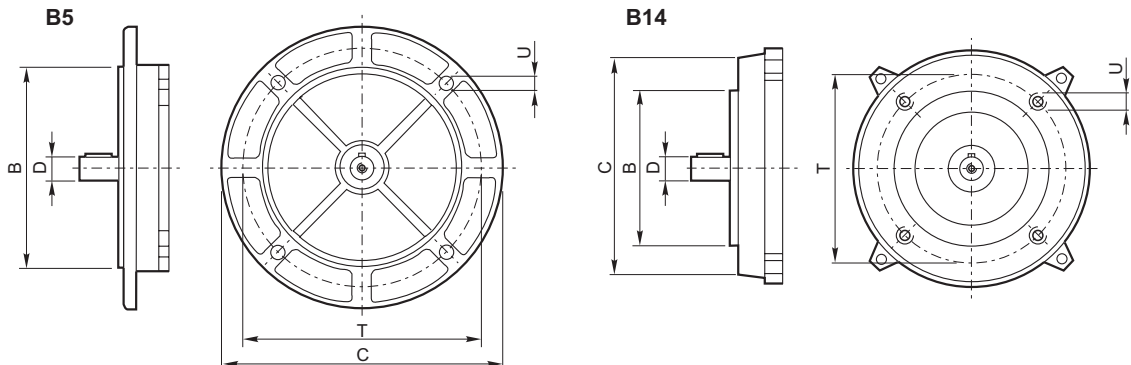
**Flansche und Lagerschilder (nach CEI-IEC 72-1)**

Die Flansche und Lagerschilder sind aus Aluminium-Druckguß und sind mit genormten Abmessungen nach CEI-IEC 72-1 oder nach Kundenzeichnung in größerer oder kleinerer Ausführung lieferbar. In der Größe 160 sind die Flansche B5 und B14 aus Guß.

**Dimensioni delle forme costruttive con flangia**

**Dimensions of design versions with flange**

**Abmessungen der Bauformen mit Flansch**



Tab.1.5

Grandezza motore Motor size Baugröße	IEC 71_1	∅ albero Shaft diam. ∅ Welle	∅ flangia B5 B5 Flange diam. ∅ Flansch B5			∅ flangia B14 B14 Flange diam. ∅ Flansch B14		
		D	C	T	B	C	T	B
50	IEC 56 Standard	9	—	—	—	80	65	50
56	IEC 56 Standard	9	120	100	80	80	65	50
	IEC 63	11	—	—	—	90	75	60
63	IEC 56	9	120	100	80	90	65	50
	IEC 63 Standard	11	140	115	95	90	75	60
	IEC 71	14	—	—	—	105	85	70
71	IEC 80	14	—	—	—	120	100	80
	IEC 56	9	120	100	80	—	—	—
	IEC 63	11	140	115	95	105	75	60
	IEC 71 Standard	14	160	130	110	105	85	70
80	IEC 80	19	—	—	—	120	100	80
	IEC 90	19	—	—	—	140	115	95
	IEC 63	11	140	115	95	—	—	—
	IEC 71	14	160	130	110	120	85	70
90	IEC 80 Standard	19	200	165	130	120	100	80
	IEC 90	24	—	—	—	140	115	95
	IEC 100/112	24	—	—	—	160	130	110
	IEC 71	14	160	130	110	—	—	—
100	IEC 80	19	200	165	130	140	100	80
	IEC 90 Standard	24	200	165	130	140	115	95
	IEC 100/112	28	—	—	—	160	130	110
	IEC 71	14	160	130	110	—	—	—
112	IEC 80	19	200	165	130	120	100	80
	IEC 90	24	200	165	130	160	115	95
	IEC 100/112 Standard	28	250	215	180	160	130	110
	IEC 132	28	—	—	—	200	165	130
132	IEC 90	24	200	165	130	140	115	95
	IEC 100/112 Standard	28	250	215	180	160	130	110
160	IEC 132 Standard	—	—	—	—	200	165	130
	IEC 100/112	28	250	215	180	—	—	—
160	IEC 132 Standard	28	300	265	230	200	165	130
	IEC 160 Standard	42	350	300	250	250	215	180

**Gradi di protezione (IP)**

Il grado di protezione standard dei motori è IP55. Sono possibili esecuzioni speciali per ambienti aggressivi con protezione migliorata o specifica, salvo diverse indicazioni in targa motore.

Il grado di protezione meccanica è stabilito in accordo alla IEC 60034-5 ed è indicato dalla dicitura IP seguita da due cifre caratteristiche.

**Housing protection level (IP)**

*IP55 standard protection rating of the motors. Special executions are possible for harsh environments with greater or specific protection except for other indications on motor rating plate.*

*The mechanical protection level is set in accordance with IEC 60034-5 and is indicated by the letters IP followed by two characteristic numbers*

**Schutzarten (IP)**

Die Motoren verfügen über die Standard-Schutzart IP55. Sonderausführungen für aggressive Umgebungen mit verstärktem oder spezifischem Schutz sind, sofern auf dem Typenschild des Motors nicht anders angegeben, lieferbar.

Die mechanische Schutzart in gemäß IEC 60034-5 festgelegt und durch die Kennzeichnung IP gefolgt von zwei Ziffern angegeben.

Tab.1.6

IP	Definizione / Definition / Erklärung	IP	Definizione / Definition / Erklärung
0	Nessuna protezione speciale <i>No special protection</i> Kein besonderer Schutz	0	Nessuna protezione speciale <i>No special protection</i> Kein besonderer Schutz
1	Protezione contro i corpi solidi superiori a 50 mm (esempio: contatti involontari della mano) <i>Protection from solid bodies larger than 50 mm (e.g.: accidental hand contact)</i> Schutz gegen feste Fremdkörper > 50 mm (Beispiel: zufälliges Berühren mit der Hand)	1	Protezione contro la caduta verticale di gocce d'acqua (condensa) <i>Protection from drops of water falling vertically (condensation)</i> Schutz gegen senkrecht fallendes Tropfwasser (Kondenswasser)
2	Protezione contro i corpi solidi superiori a 12 mm (esempio: contatti involontari delle dita della mano) <i>Protection from solid bodies larger than 12 mm (e.g.: accidental contact with fingers)</i> Schutz gegen feste Fremdkörper > 12 mm (Beispiel: zufälliges Berühren mit den Fingern)	2	Protezione contro la caduta verticale di gocce d'acqua con un'inclinazione fino a 15° <i>Protection from drops of water falling vertically at angles up to 15°</i> Schutz gegen senkrecht fallendes Tropfwasser mit einem Schrägwinkel bis 15°
3	Protezione contro i corpi solidi superiori a 2.5 mm (esempio: fili utensili) <i>Protection from solid bodies larger than 2.5 mm (e.g.: tool cables)</i> Schutz gegen feste Fremdkörper > 2,5 mm (Beispiel: Drähte, Werkzeuge)	3	Protezione contro gli spruzzi d'acqua con inclinazione fino a 60° <i>Protection from sprayed water at angles of up to 60°.</i> Schutz gegen Sprühwasser mit einem Schrägwinkel bis 60°
4	Protezione contro i corpi solidi superiori a 1 mm <i>Protection from solid bodies larger than 1 mm</i> Schutz gegen feste Fremdkörper > 1 mm	4	Protezione contro i getti d'acqua provenienti da tutte le direzioni <i>Protection from water spray coming from all direction</i> Schutz gegen Spritzwasser, das aus allen Richtungen gegen die Maschine spritzt
5	Protezione contro la polvere (non deve penetrare in quantità dannosa) <i>Protection from dust (must not penetrate in dangerous quantities)</i> Schutz gegen Staubablagerungen (darf nicht in schädlichen Mengen eindringen)	5	Protezione contro l'acqua proiettata con un ugello sul motore da tutte le direzioni <i>Protection from water sprayed with a nozzle on the motor from all directions</i> Schutz gegen Strahlwasser, das mit einer Düse aus allen Richtungen auf den Motor gerichtet wird.
6	Protezione completa contro la polvere <i>Complete protection from dust</i> Vollständiger Schutz gegen Staubablagerung	6	Protezione contro i getti d'acqua potenti da tutte le direzioni (non deve penetrare in quantità dannosa) <i>Protection from water spray coming from all directions (must not penetrate in dangerous quantities)</i> Schutz gegen starkes Strahlwasser, das aus allen Richtungen gegen die Maschine gerichtet ist (darf nicht in schädlichen Mengen eindringen)
		7	Protezione contro gli effetti dell'immersione tra 0.15 1 m <i>Protection from the effects of immersion between 0.15 and 1 m</i> Schutz beim Eintauchen zwischen 0,15 und 1 m
		8	Protezione contro gli effetti prolungati dell'immersione in acqua alle condizioni concordate tra il produttore e l'utilizzatore <i>Protection from the effects of prolonged immersion in water at conditions agreed between the manufacturer and user</i> Schutz bei verlängertem Untertauchen zu zwischen Hersteller und Anwender vereinbarten Bedingungen

**Caratteristiche nominali e di funzionamento**  
(secondo CEI EN 60034-1/IEC 34-1)

**P<sub>n</sub> - Potenza nominale [KW]:**

è la potenza meccanica resa all'albero, espressa secondo le norme internazionali in kW, la troverete nelle tabelle anche espresse in HP.

**V<sub>n</sub> - Tensione nominale [Volt]:**

la tensione da applicare in entrata, ai morsetti dei motori nelle configurazioni standard 230V / 400V / 50Hz/S1.

Nei motori asincroni trifasi è tollerabile una variazione di tensione fino a  $\pm 10\%$  dei valori nominali (Tab. 10 - pag A28)

**Ca - Coppia di avviamento [Nm]:**

coppia minima che fornisce il motore a rotore bloccato, alimentato con tensione e frequenza nominali.

**C<sub>max</sub> - Coppia massima [Nm]:**

è la coppia massima che il motore può sviluppare durante il suo funzionamento alimentato con tensione e frequenza nominali, senza arrestarsi o rallentare bruscamente.

**C<sub>n</sub> - Coppia nominale [Nm]:**

è la coppia risultante della potenza nominale ai giri nominali. Il valore della coppia nominale è dato dalla formula:

**P<sub>n</sub>** = potenza nominale espressa in kW

**n** = velocità di rotazione nominale espressa in giri/minuto

**ns - Velocità di sincronismo:**

la velocità di sincronismo (vedi grafico) è data dalla formula:

**Nominal and operating specifications**  
(per CEI EN 60034-1/IEC 34-1)

**P<sub>n</sub> - Rated power [KW]:**

This is the mechanical power supplied to the shaft, expressed in kW per international standards. You will also find it expressed in HP in the tables.

**V<sub>n</sub> - Rated voltage [Volt]:**

This is the incoming voltage to be applied to the motor terminals in standard configurations 230 V/400V/ 50 Hz/S1. In asynchronous three-phase motors, a voltage variation of up to  $\pm 10\%$  of rated values is tolerable (Tab. 10 - pag. A28).

**Ca - Starting torque [Nm]:**

Minimum torque provided by the motor with the rotor blocked, powered at the rated voltage and frequency.

**C<sub>max</sub> - Maximum torque [Nm]:**

this is the maximum torque that the motor can develop during operation when powered at the rated voltage and frequency, without brusquely stopping or slowing down.

**C<sub>n</sub> - Rated torque [Nm]:**

This is the torque resulting from the rated power at the rated rpm. The rated torque value is determined by the formula:

$$C_n = 9740 \cdot \frac{P_n}{n} \quad [\text{Nm}]$$

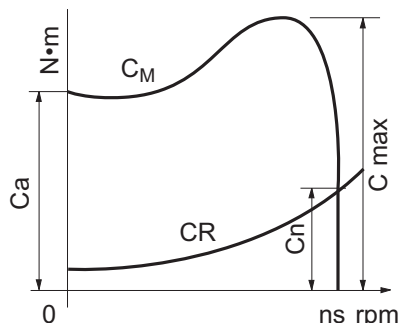
**P<sub>n</sub>** = rated power expressed in kW

**n** = rated rotation speed expressed in rpm

**ns - Synchronous speed:**

The synchronous speed (see graph) is determined by the formula:

$$n_s = \frac{f \cdot 120}{p} \quad [\text{rpm}]$$



<b>f</b>	frequenza di alimentazione espressa in Hz	supply frequency expressed in Hz
<b>P</b>	numero di poli	number of poles
<b>CR</b>	coppia resistente	resistance torque
<b>Ca</b>	coppia di avviamento	starting torque
<b>Cmax</b>	coppia massima	maximum torque
<b>Cn</b>	coppia nominale	rated torque
<b>rpm</b>	giri/min.	rounds per minutes
<b>C<sub>M</sub></b>	coppia motrice	drive torque

**Nennwerte und Betriebseigenschaften**  
(nach CEI EN 60034-1/IEC 34-1)

**P<sub>n</sub> - Nennleistung [KW]:**

Ist die an die Welle abgegebene mechanische Leistung, die nach den internationalen Normen in kW ausgedrückt wird. In einigen Tabellen wird sie auch in HP angegeben.

**V<sub>n</sub> - Nennspannung [Volt]:**

Ist die Spannung, die an den Klemmen von Motoren in der Standardausführung 230V/400V/ 50Hz/S1 angelegt sein muß. Bei Drehstrom-Asynchronmotoren ist eine Abweichung von  $\pm 10\%$  von den Nennwerten akzeptabel (Tab. 10 - Seite A28).

**Ca - Anlaufmoment [Nm]:**

Kleinste Moment, das der Motor mit Nennspannung und -frequenz bei blockiertem Läufer liefert.

**C<sub>max</sub> - Höchstmoment [Nm]:**

Höchste Moment, das der Motor während seines Betrieb mit Nennspannung und -frequenz ohne anzuhalten und ohne abruptes Abbremsen entwickeln kann.

**C<sub>n</sub> - Nennmoment [Nm]:**

Ist das Moment, das sich aus der Nennleistung bei Nenndrehzahl ergibt. Der Wert des Nennmoments wird mit der folgenden Formel berechnet:

**P<sub>n</sub>** = Nennleistung in kW

**n** = Motordrehzahl in min<sup>-1</sup>

**ns - Synchrongeschwindigkeit:**

Die Synchrongeschwindigkeit (siehe Schaubild) wird mit der folgenden Formel berechnet:

Speisefrequenz in Hz
Anzahl der Pole
Widerstandsmoment
Anlaufmoment
Höchstmoment
Nennmoment
Umdrehungen/Minute
Antriebsmoment

**Altitudine e temperatura**

I motori, salvo diverso accordo con il costruttore, sono progettati per il funzionamento alle seguenti caratteristiche nominali:

- 1) altitudine inferiore a 1000 m s.l.m..
- 2) massima temperatura ambiente di funzionamento inferiore a 40 °C
- 3) minima temperatura ambiente dell'aria -15 °C (+ 5 °C per motori di potenza nominale inferiore a 600 W).
- 4) U.R. ≤ 60%

Per condizioni ambientali diverse da quelle nominali, le potenze variano come indicato nel seguente diagramma:

$$P_{reale} = \text{coeff.} \times P_n$$

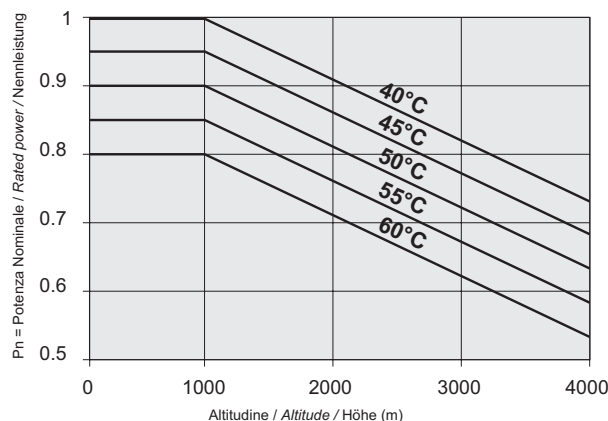
**Altitude and temperature**

Unless otherwise agreed with the manufacturer, the machines are designed to run under the following nominal conditions:

- 1) Altitude below 1000 m a.s.l.
- 2) Maximum ambient running temperature below 40 °C
- 3) Minimum ambient air temperature -15 °C (+5 °C for machines with a rated power below 600W).
- 4) R.H. = 60%

For ambient conditions other than those stated above, the powers vary as indicated in the following diagram:

COEFFICIENTE TEMPERATURA / TEMPERATURE COEFFICIENT / TEMPERATURKOEFFIZIENT

**Tipi di servizio**

I motori riportati a catalogo hanno la potenza riferita ad un servizio S1.

Per condizioni applicative diverse è necessario identificare il tipo di servizio facendo riferimento alle Norme CEI EN 60034-1.

A titolo esemplificativo riportiamo le condizioni di funzionamento relative ai tipi S1 e S2.

S1 - S9: pag. D10

**Attenzione**

Per quanto riguarda i motori monofase, si raccomanda di specificare correttamente il servizio termico di funzionamento. Esempio: S3 30%, in quanto in questo particolare motore assume grande importanza la marcia a vuoto ai fini del riscaldamento, e questo perché la macchina è elettricamente squilibrata.

**S1 - Servizio continuo:**

funzionamento del motore a carico costante per un periodo di tempo indefinito, comunque sufficiente a raggiungere l'equilibrio termico.

**S2 - Servizio di durata limitata:**

funzionamento del motore a carico costante per un periodo di tempo limitato insufficiente a raggiungere l'equilibrio termico, seguito da un periodo di riposo sufficiente a riportare il motore a temperatura ambiente.

**Type of duty**

The power of the motors shown in the catalogue refers to S1 duty.

For different applicational conditions the type of duty must be identified by referring to CEI EN 60034-1 standards.

As an example the following are the operating conditions for S1 and S2 types.

S1 - S9: page D10

**Attention**

For single-phase motors, the thermal operating duty must be correctly specified. Example: S3 30%, as for this motor no-load operation is quite important for heating purposes, since the machine is electrically unbalanced.

**S1 - Continuous duty:**

motor operating at a constant load for an indefinite period of time, in any case enough to reach thermal balance.

**S2 - Limited duty:**

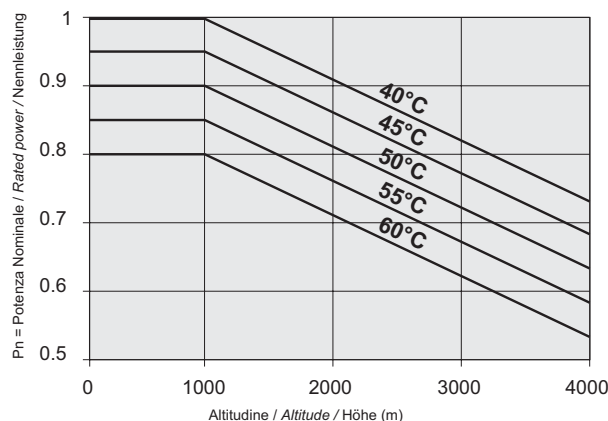
motor operating at a constant load for limited period of time not long enough to reach thermal balance, followed by a rest period sufficient to bring the motor back to ambient temperature.

**Höhe und Temperatur**

Die Motoren werden, falls nicht anders mit dem Hersteller vereinbart, für die folgenden Einsatzbedingungen ausgelegt:

- 1) Höhe unter 1000 m ü.d.M.
- 2) max. Umgebungstemperatur unter 40°C.
- 3) min. Umgebungslufttemperatur -15°C (+5°C bei Maschinen mit einer Nennleistung unter 600W).
- 4) relative Luftfeuchtigkeit = 60% Bei von den Nennwerten abweichenden Umgebungsbedingungen ändern sich die Leistungen gemäß folgendem Diagramm:

COEFFICIENTE TEMPERATURA / TEMPERATURE COEFFICIENT / TEMPERATURKOEFFIZIENT

**Betriebsarten**

Für die im Katalog aufgeführten Motoren bezieht sich die Leistungsangabe auf die Betriebsart S1.

Für abweichende Einsatzbedingungen ist die Betriebsart nach CEI EN 60034-1 anzugeben.

Als Beispiel führen wir die Betriebsbedingungen für die Betriebsarten S1 und S2 an.

S1 - S9: Seite D10

**Achtung**

Bei Wechselstrommotoren ist eine genaue Angabe des thermischen Verhaltens sehr wichtig (z.B. S3 30%), da diese Art von Motor elektrisch nicht abgeglichen ist und der Leerlauf deshalb eine wichtige Rolle bei der Erwärmung des Motors spielt.

**S1 - Dauerbetrieb:**

Betrieb des Motors mit konstanter Last über einen unbestimmten Zeitraum, der für die Erreichung des Temperaturgleichgewichts ausreichend ist.

**S2 - Betrieb von begrenzter Dauer:**

Betrieb des Motors mit konstanter Last über einen begrenzten Zeitraum, der für die Erreichung des Temperaturgleichgewichts nicht ausreichend ist, gefolgt von einem Ruhezeitraum, der für die Abkühlung des Motors auf Umgebungstemperatur ausreichend ist.

## Controllo dei motori serie T con inverter (V/F) costante

I motori asincroni trifase riportati a catalogo, possono essere controllati con ottimi risultati tramite inverter a V/F costante.

Tali motori sono stati specificatamente progettati pensando ad un eventuale loro impiego a velocità, coppia e potenza variabili.

Quindi, grazie all'impiego di materiali di elevata qualità, è stato possibile ottenere prestazioni elevate in termini di temperature modeste, alti rendimenti anche controllati da inverter.

Prove pratiche sui motori hanno consentito di evidenziare nel grafico sottostante le prestazioni ottenute (i valori indicati sono puramente indicativi e non impegnativi per STM).

## Controlling standard STM motors T series with constant inverter (V/F)

*The three-phase induction motors shown in the catalogue can be controlled with excellent results by means of a constant V/F inverter.*

*These motors have been specifically designed to be used at variable speed, torque and power.*

*Therefore, through the use of high quality materials, it has been possible to obtain high performance in terms of reasonable temperatures, high output also controlled by inverter.*

*Practical tests carried out on the motors have resulted in the performances shown on the graph below (the values shown are purely approximate and not binding upon STM).*

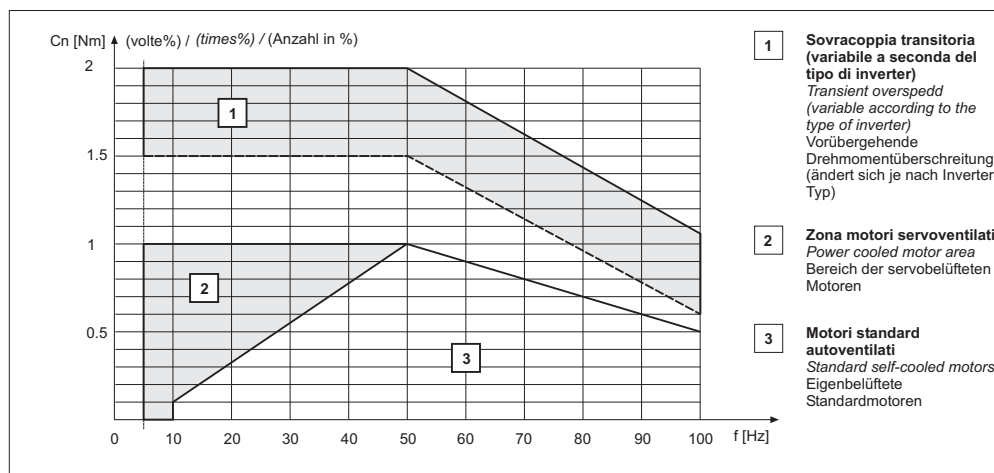
## Überwachung der STM-Standardmotoren Serie T für Inverter mit konstanten V/f

Die im Katalog aufgeführten Drehstrom-Asynchronmotoren können mit ausgezeichneten Resultaten über Inverter mit konstanten V/f überwacht werden.

Diese Motoren sind eigens für einen etwaigen Einsatz mit verstellbarer Drehzahl, Drehmoment und Leistung konzipiert. Aufgrund der Verwendung von hochwertigen Materialien konnten hohe Leistungsmerkmale in punkto mäßige Temperaturbereiche und hohe Wirkungsgrade erzielt werden, die auch inverterüberwacht sind.

Praktische Tests an den Motoren haben die Leistungswerte ergeben, die im nachstehenden Diagramm aufgeführt sind (die angegebenen Werte sind ausschließlich Richtwerte und für STM nicht verbindlich).

Tab.1.7



### Attenzione

Nel caso di controllo motori serie T con inverter, non si dà garanzia di durata in quanto l'isolamento è sottoposto a picchi elevati di tensione.

### Attention

In case you control standard serie T with inverter, we are not able to guarantee the duration, because the insulation is subject to high peaks of voltage.

### Achtung

Bei Überwachung der Motoren Serie T mit Inverter kann keine Gewähr für die Lebensdauer des Motors übernommen werden, da die Isolierung hohen Spannungsspitzen ausgesetzt ist.

## Caratteristiche di coppia

In questo grafico le curve definiscono la coppia permanente e la zona 1 di sovracoppia transitoria (di durata limitata) resa da un motore standard autoventilato e su di un motore servoventilato.

Nel caso del motore autoventilato (zona 3) la coppia al di sotto dei 50 Hz nominali dev'essere opportunamente limitata a causa della ridotta autoventilazione affinché la temperatura degli avvolgimenti non raggiunga livelli pericolosi per la loro integrità.

Naturalmente questa limitazione può essere evitata adottando una servoventilazione del motore indipendente o, nel caso il funzionamento a bassi giri, si verifichi solo per brevi periodi di tempo con intervalli di riposo sufficienti al raffreddamento del motore (zona 2). La servoventilazione va scelta di portata [ $m^3 / min$ ] adeguata al servizio termico del motore.

Per un maggiore controllo delle temperature, se si prevede di utilizzare il motore, con elevate coppie, maggiori della nominale, o a bassa velocità di rotazione, l'utilizzo di una termica bimetallica è sconsigliata.

## Torque characteristics

*In this graph, the curves define the permanent torque and the transient overspeed area (limited duration) on a standard, self-cooled motor and a power cooled motor.*

*In the case of the self-cooled motor (area 3), the torque below a rated 50 Hz must be appropriately limited due to the reduced self-cooling so that the winding temperature does not reach levels hazardous to their integrity.*

*This limitation may obviously be avoided by adopting independent power cooling of the motor or, for low rpm operation, if it occurs only briefly with rest intervals sufficient to cool the motor (area 2).*

*Power cooling should be selected with a throughput [ $m^3 / min$ ] suited to the thermal duty of the motor.*

*For greater temperature control, if the motor is to be used with a torque above the rated level or at a low rotation speed, we recommend using a bimetallic thermal cut-out switch.*

## Drehmomentmerkmale

In dieser grafischen Darstellung wird das Nennmoment und die vorübergehende Drehmomentüberschreitung (Bereich 1, nur für eine beschränkte Zeit) für servobelüftete und eigenbelüftete Standardmotoren durch Kurven dargestellt.

Beim eigenbelüfteten Motor (Bereich 3) muß das Drehmoment unter 50 Hz aufgrund der verminderten Eigenbelüftung entsprechend beschränkt werden, um die Wicklung vor Überhitzung zu schützen. Die Beschränkung kann durch eine eigenständige Servobelüftung des Motors oder durch für die Abkühlung des Motors ausreichend lange Stillstandzeiten (Bereich 2) beim Betrieb im niedrigen Drehzahlbereich umgangen werden.

Die Leistung der Servobelüftung [ $m^3 / min$ ] muß entsprechend dem thermischen Verhalten des Motors gewählt werden. Wenn das Nennmoment des Motors häufig überschritten oder wenn mit niedrigen Drehzahlen gearbeitet wird, kann die Temperaturüberwachung durch den Einsatz von Bimetall-Temperaturfühlern merklich verbessert werden.

**Carichi Assiali**

**Axial loads**

**Axialbelastungen**

La seguente tabella riporta i valori dei carichi massimi [N] assiali a 50Hz applicabili, calcolati per una durata di funzionamento di:  
 - 20.000 ore per motore a 2 poli  
 - 40.000 ore per motore a 4-6-8-10-12 poli  
 Per motori a 60 Hz. ridurre il valore di circa un 6%.

The table below shows the maximum applicable axial loads [N] at 50 Hz, calculated for a running life of:  
 - 20,000 hours for 2-pole motors  
 - 40,000 hours for 4-6-8-10-12 pole motors  
 Reduce values by approximately 6% for 60-Hz motors.

In der nachfolgenden Tabelle sind die max. bei 50 Hz zulässigen Axial- belastungen [N] aufgeführt für eine Betriebsdauer von:  
 -20.000 Stunden bei 2poligen Motoren  
 -40.000 Stunden bei 4-, 6-, 8-, 10- und 12-poligen Motoren. Bei Frequenzen von 60Hz müssen die angegebenen Werte um ca. 6% vermindert werden.

Grandezza Size Baugröße	Motori orizzontali / <i>Horizontally- mounted motors</i> / Waagerechter Einbau								Motori verticali / <i>Vertically- mounted motors</i> / Senkrechter Einbau							
	Velocità / <i>Speed</i> / Drehzahl (min <sup>-1</sup> )															
	750	1000	1500	3000	750	1000	1500	3000	750	1000	1500	3000	750	1000	1500	3000
<b>50</b>	—	—	120	100	—	—	120	100	—	—	100	80	—	—	110	90
<b>56</b>	230	200	160	120	230	200	160	120	220	160	120	100	230	170	130	110
<b>63</b>	320	300	250	200	320	300	250	200	300	290	240	190	320	310	260	210
<b>71</b>	380	360	300	240	380	360	300	240	365	345	285	230	395	375	315	250
<b>80</b>	480	430	370	300	480	430	370	300	450	400	340	280	510	460	400	320
<b>90</b>	650	600	510	400	650	600	510	400	600	550	470	360	700	650	550	440
<b>100</b>	850	750	580	500	850	750	580	500	770	670	500	430	930	830	660	570
<b>112</b>	1300	1250	950	700	1000	900	750	600	1200	1150	850	620	1100	1000	850	680
<b>132</b>	1800	1700	1350	800	1300	1100	900	700	1600	1500	1150	650	1500	1300	1100	850
<b>160</b>	2800	2500	2100	1700	1400	1200	1000	800	2500	2300	2000	1500	1600	1500	1300	1000



**Carichi Radiali**

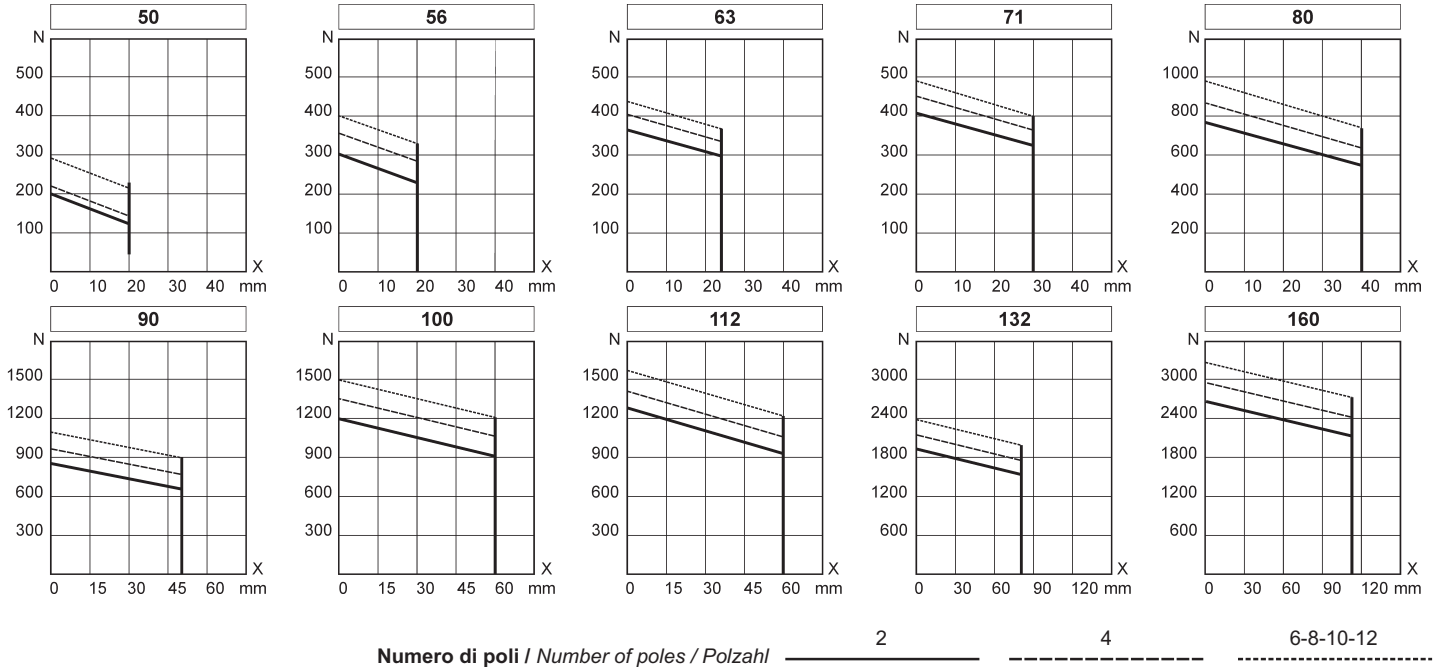
**Radial loads**

**Radialbelastungen**

Da questi diagrammi è possibile ricavare i valori dei carichi massimi  $F_r$  [N] applicabili (senza l'applicazione di un carico assiale supplementare, in funzione del punto di applicazione del carico X).

These diagrams make it possible to determine the maximum applicable loads [N] (without the application of a supplementary axial load, depending on the point of application of the X load).

Aus den nachfolgenden Diagrammen können die max. zulässigen Radialbelastungen [N] (ohne zusätzliche Axiallast, in Abhängigkeit vom Belastungspunkt X).



**Carichi radiali nel caso di utilizzo di pulegge e cinghie**

Qualora l'accoppiamento del motore avvenga mediante cinghie, occorre verificare che il carico radiale gravante sull'albero non superi i valori massimi consentiti. Tale verifica può essere effettuata utilizzando la seguente formula:

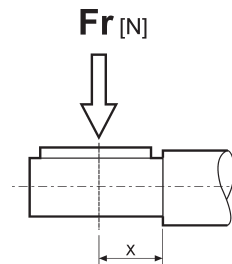
**Radial load when using pulleys and belts**

If the motor is coupled by belts, make sure the radial load on the shaft does not exceed the maximum allowed values. This may be checked using the following formula:

**Radialbelastung beim Einsatz von Riemenscheiben und Riemen**

Bei Verwendung von Riemen muß geprüft werden, ob die Radialbelastung der Welle innerhalb der max. zulässigen Werte liegt. Diese Prüfung kann mit Hilfe der folgenden Formel durchgeführt werden:

$$F_r = \frac{19100 \cdot P_n \cdot K}{n_n \cdot D}$$



$F_r$  = Carico radiale sull'albero in N  
 $P_n$  = Potenza in kW  
 $n_n$  = Velocità dell'albero in  $min^{-1}$   
 $D$  = Diametro puleggia in m  
 $K$  = Coefficiente di tensione della cinghia i cui valori indicativi sono:

$F_r$  = Radial load in N  
 $P_n$  = Power in kW  
 $n_n$  = Shaft speed in  $min^{-1}$   
 $D$  = Pulley diameter in meters  
 $K$  = Coefficient of belt for which the indicative values are:

$F_r$  = Radialbelastung in N  
 $P_n$  = Leistung in kW  
 $n_n$  = Drehzahl des Welle in  $min^{-1}$   
 $D$  = Ø der Riemenscheibe in Metern  
 $K$  = Beanspruchungskoeffizient des Riemen. Weisend wert sind:

- 2 pulegge piane con rullo tendicinghia
- 2.25 pulegge a gola trapezoidale
- 2.5 - 3 per servizi gravosi e altre pulegge

- 2 flat pulleys with belt stretcher roller
- 2.25 for trapezoid groove pulleys
- 2.5 - 3 for heavy duty and other pulleys

- 2 für Flachriemen mit Spannrolle
- 2.25 für Keilriemen
- 2.5 - 3 Belastungen und andere Riemenscheiben

**Rumorosità**

Le misure della pressione sonora e della potenza sonora sono state eseguite sui motori monofase e trifase, ad un metro di distanza dalla macchina, ponderati secondo la curva A (ISO R 1680).

Questi valori misurati a 50 Hz si aumentano mediamente di 4 dBA per 60 Hz.

**Noise level**

*Sound pressure and power levels were measured on single- and three-phase motors, one meter away from the machine, and weighted according to curve A (ISO R 1680).*

*At 50 Hz for relative values at 60 Hz, this increases by an average of 4 dbA.*

**Geräuschpegel**

Bei den Wechsel- und Drehstrommotoren wurden der Schalldruck und die Schalleistung in einem Abstand von einem Meter von der Geräuschquelle gemessen und gemäß Kurve A gewichtet (ISO R 1680).

Die Meßwerte beziehen sich auf 50 Hz. Bei einer Frequenz von 60 Hz müssen die Werte um durchschnittlich 4 dBA erhöht werden.

Tab.1.8

Grandezza motore Motor size Größe Motor	Pressione sonora A (LpA) - Potenza sonora A (LWA) Sound pressure level at (LpA) - Sound power level at (LWA) Schalldruckpegel A (LpA) - Schalleistungspegel A (LWA)							
	2 poli / poles / poling		4 poli / poles / poling		6 poli / poles / poling		8 poli / poles / poling	
	L <sub>WA</sub>	L <sub>pA</sub>	L <sub>WA</sub>	L <sub>pA</sub>	L <sub>WA</sub>	L <sub>pA</sub>	L <sub>WA</sub>	L <sub>pA</sub>
<b>50</b>	59	69	55	65	50	60	47	57
<b>56</b>	60	70	56	66	51	61	48	58
<b>63</b>	62	72	58	68	53	63	50	60
<b>71</b>	64	74	59	69	55	65	52	62
<b>80</b>	68	78	61	71	58	68	55	65
<b>90</b>	70	80	63	73	60	70	58	68
<b>100</b>	74	84	65	75	62	72	60	70
<b>112</b>	76	86	66	76	62	72	60	70
<b>132</b>	77	87	66	76	62	72	60	70
<b>160</b>	78	88	66	76	62	72	60	70

## 1.4 CARATTERISTICHE ELETTRICHE

### Rotori

Sono a gabbia di scoiattolo in pressofusione di alluminio o lega di (Al- Si) Silumin.

### Statori avvolti

Per la maggior parte della produzione sono utilizzate lamiere magnetiche con elevata qualità CP= 10 W /Kg (50Hz/1T), tali da assicurare comunque una costanza di prestazioni ed elevati rendimenti.

Il rame utilizzato è impregnato con un doppio strato di smalto isolante per assicurare un'elevata tenuta alle sollecitazioni elettriche, termiche e meccaniche.

Gli strati di materiale isolante sono in NOMEX /D.M./D.M.D./N.M./N.M.N./M. con classe di isolamento H.

La temperatura ambiente considerata è di 40 °C. Sono disponibili processi di tropicalizzazione con impregnazione tramite vernici di elevate qualità igroscopiche, per l'uso in ambienti di elevata umidità >60% U.R.

### Classe di isolamento

Gli avvolgimenti, realizzati con filo a doppio smalto al massimo della tolleranza e sottoposti ad impregnazione sotto vuoto, sono isolati in **classe F** garantendo in tal modo un margine termico massimo di 155 °C, conforme alle prescrizioni delle principali normative.

Per particolari applicazioni è possibile fornire (a richiesta) l'isolamento in classe H e motori sottoposti a trattamenti speciali per renderli atti a funzionare in ambienti umidi e corrosivi.

## 1.4 ELECTRICAL SPECIFICATIONS

### Rotors

These are die-cast aluminum or Silumin alloy (Al-Si) squirrel-cage rotors.

### Wound Stators

High-quality magnetic sheet metals are used for most of the production, CP = 10 W/kg (50Hz/1T) to ensure constant high performance.

The copper used is impregnated with a double layer of insulating enamel to ensure high resistance to electrical, thermal and mechanical stress.

The layers of insulating material are made of NOMEX /D.M./D.M.D./N.M./N.M.N./M. with insulation class H.

The ambient temperature considered is 40 °C. Tropicalization processes are available through impregnation with paints having high hygroscopic qualities, for use in areas with high ambient humidity >60% R.H.

### Insulation class

Windings are made of copper wire with double thickness enamelling and are subjected to vacuum impregnation.

They are also **class F** insulated granting a maximum thermal margin of 155 °C according to the main specifications.

For particular applications it is possible to supply (upon request) class H insulated motors.

Specially treated motors suitable to operate in humid and corrosive ambients are also available upon request.

## 1.4 ELEKTRISCHE EIGENSCHAFTEN

### Läufer

Es handelt sich dabei um Käfigläufer aus Aluminium-Druckguß oder Silumin-Legierung (Al-Si).

### Statorwicklung

In unserer Hauptproduktion wird hochqualitatives Magnetblech des Typs CP= 10 W/kg (50Hz/1T) eingesetzt, das gleichmäßig hohe Leistungen gewährleistet.

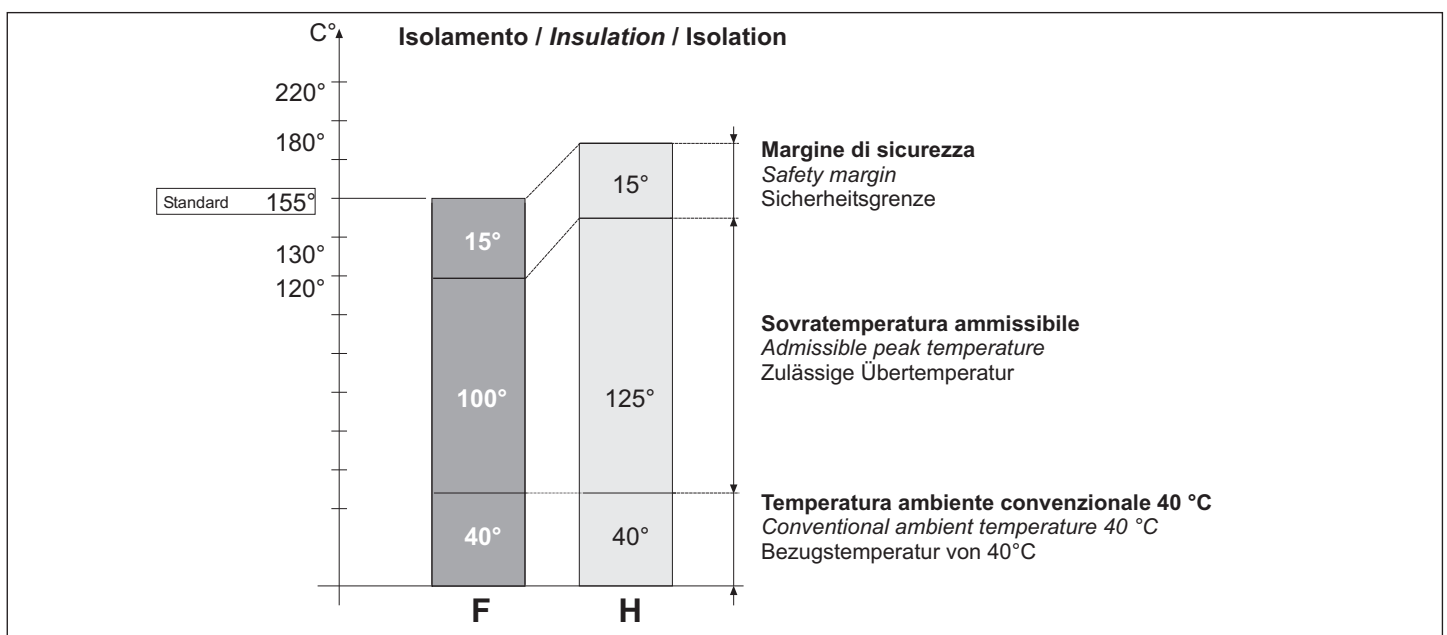
Der verwendete Kupferdraht ist durch eine doppelte Lackschicht isoliert, die für äußerst hohe Widerstandsfähigkeit gegen elektrische, thermische und mechanische Belastungen sorgt. Die Isolierschicht ist aus NOMEX/D.M./D.M.D./N.M./N.M.N./M. und entspricht der Iso-Klasse H.

Es wird eine Umgebungstemperatur von 40° C angenommen. Die Tropenausführung sieht die Impregnierung mit hochqualitativen, hygroskopischen Lacken für den Einsatz in Umgebungen mit einer relativen Luftfeuchtigkeit von über 60% vor.

### Isolationsklasse

Die Wicklungen sind mit einer doppelten Lackschicht versehen und vakuumimpregniert. Sie sind nach **Klasse F** isoliert und garantieren somit einen den einschlägigen Normen entsprechenden maximalen Temperaturgrenzwert von 155°C.

Für besondere Anforderungen können die Motoren auf Anfrage mit einer Isolierung nach Klasse H und speziellen Schutzbehandlungen für feuchte und korrosive Arbeitsumgebungen geliefert werden.



**Tensioni e frequenze  
(secondo CEI EN 60034-1)**

la normativa EN 60034-1 precisa la tensione nominale consentita, indicando un valore di  $\pm 5\%$ .

In conformità alla normativa IEC 60038 le tensioni principali devono avere un valore di tolleranza di  $\pm 10\%$ .

I motori sono quindi progettati per funzionare in un "range" di tensione nominali (vedere tabella 1.9).

Nella gamma dei motori con le presenti tensioni nominali, non viene superata la temperatura ammissibile (Zona A).

Se i motori funzionano al limite della tolleranza di tensione, la sovratemperatura ammissibile dell'avvolgimento dello statore può superare il valore massimo di 10 K (Zona B).

**Voltages and frequencies  
(according to CEI EN 60034-1)**

The EN 60034-1 standard states the permitted rated voltage, indicating a value of  $\pm 5\%$ .

In accordance with IEC 60038 standard the main voltages must have a tolerance value of  $\pm 10\%$ .

The motors are therefore designed to operate within a rated voltage "range" (see table 1.9).

In the series of motors with the present rated voltages, the permitted temperature is not exceeded (Zone A).

If the motors operate at the voltage tolerance limit, the permitted excess temperature for the stator winding may exceed the maximum value by 10 K (Zone B).

**Spannungen und Frequenzen  
(gemäß CEI EN 60034-1)**

Die Norm EN 60034-1 legt die zulässige Nennspannung mit einer Toleranz von  $\pm 5\%$  fest.

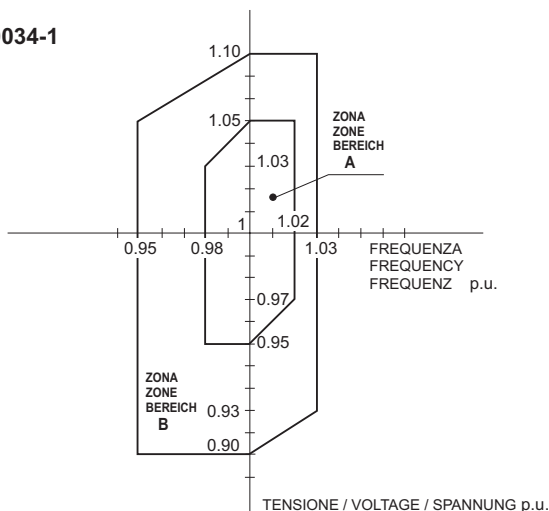
Gemäß der Norm IEC 60038 müssen die Hauptspannungen einen Toleranzwert von  $\pm 10\%$  haben.

Die Motoren sind daher für den Betrieb in einem „Bereich“ von Nennspannungen konzipiert (siehe Tabelle 1.9).

In der Motorenpalette mit den vorliegenden Nennspannungen wird die zulässige Temperatur nicht überschritten (Bereich A).

Wenn die Motoren im Grenzbereich der Spannungstoleranz arbeiten, kann die zulässige Übertemperatur der Statorwicklung den Höchstwert von 10 K überschreiten (Bereich B).

CEI EN 60034-1



**ZONA / ZONE / BEREICH A :** Servizio normale continuo  
Normal continuous duty  
Normaler Dauerbetrieb

**ZONA / ZONE / BEREICH B :** Servizio pesante limitato  
Heavy limited duty  
Beschränkter Schwerlastbetrieb

**PUNTO1 / POINT / PUNKT1 :** Funzione principale  
Main function  
Hauptfunktion

Tab.1.9

Tensione / frequenza nominali range di tensioni Rated voltage/frequency Rated voltage/frequency range Nennspannung/-frequenz Bereich der Nennspannungen/-frequenzen					
Grandezza Size Größe	Tensioni nominali [V] Rated voltage [V] Nennspannungen [V] $\pm 10\%$ (IEC 60038)		Range di tensioni nominali [V] Rated voltage range [V] Nennspannungsbereich [V] $\pm 5\%$		Indicazione Designazione Indication Designation Angabe der Bezeichnung
	(50 Hz)	(60 Hz)	(50 Hz) Zona / Zone / Bereich A (CEI EN 60034-1)	(60 Hz) Zona / Zone / Bereich A (CEI EN 60034-1)	
<b>Trifase / Three-phase / Drehstrom T - H - I - S - R</b>					
<b>56 - 112</b>	230/400 $\Delta / Y$	265/460 $\Delta / Y$	220-240 / 380-415	255-277 / 440-480	—
<b>160</b>	400/690 $\Delta / Y$	460 $\Delta$	380-415 / 660-717	440-480	—
<b>132</b>	230/400 $\Delta / Y$	265/460 $\Delta / Y$	220-240 / 380-415	255-277 / 440-480	<b>A</b>
	400/690 $\Delta / Y$	460 $\Delta$	380-415 / 660-717	440-480	<b>B</b>
<b>Trifase / Three-phase / Drehstrom D - DA</b>					
<b>Tutti / All / Alles</b>	400 50 Hz	—	380- 415		—
<b>Monofase / Single-phase / Einphasen M - MD - MC - MR - ME</b>					
<b>Tutti / All / Alles</b>	230 50 Hz	—	220 - 240		—
<b>Monofase / Single-phase / Einphasen MF</b>					
<b>Tutti / All / Alles</b>	115/230 50/60 Hz		110-120/220-240 50/60 Hz		—

**Frequenza 60 Hz**

In questo catalogo tutti i dati elettrici sono riferiti a motori trifasi avvolti a 50 Hz. Questi possono essere collegati a 60 Hz tenendo conto dei coefficienti moltiplicativi della tabella seguente:

**Frequencies at 60 Hz**

All electrical data in this catalogue refer to three-phase wound motors at 50 Hz. These may be connected to 60 Hz, taking into account the multiplier coefficients in the table 13 below:

**Frequenz von 60 Hz**

Alle in diesem Katalog aufgeführten elektrischen Daten beziehen sich auf Drehstrommotoren mit einer Frequenz von 50 Hz. Sie können an 60 Hz angeschlossen werden, wobei die in der Tabelle 13 aufgeführten Multiplikationsfaktoren berücksichtigt werden müssen.

Tab.1.10

Volt di targa a 50 Hz Rated voltage at 50 Hz Volt bei 50 Hz gemäß Typenschild	Volt a 60 Hz Volt at 60 Hz Volt bei 60 Hz	Potenza nominale W Rated power W Nennleistung W	rpm	In	Ia / In	Ca / Cn	C max / Cn
220	220	1.00	1.2	1.20	0.80	0.80	0.80
220	230	1.05	1.2	1.15	0.85	0.85	0.85
220	240	1.06	1.2	1.10	0.87	0.87	0.87
*230	230	1.00	1.2	1.20	0.80	0.80	0.80
230	240	1.10	1.2	1.15	0.90	0.90	0.90
230	260	1.20	1.2	1.00	1.00	1.00	1.00
*400	400	1.00	1.2	1.20	0.80	0.80	0.80
400	440	1.06	1.2	1.10	0.87	0.87	0.87
400	460	1.20	1.2	1.00	1.00	1.00	1.00
400	480	1.25	1.2	1.00	1.10	1.10	1.10
440	440	1.00	1.2	1.20	0.80	0.80	0.80
500	500	1.00	1.2	1.20	0.80	0.80	0.80
500	550	1.06	1.2	1.10	0.87	0.87	0.87

Dove, dalle righe (\*) si ricava che un motore avvolto a 50 Hz può funzionare a 60 Hz alle medesime tensioni nominali, alla medesima potenza resa [W], con un incremento a 1.2 volte dei giri [rpm] e della corrente nominale In, e un calo a 0.8 volte della corrente di spunto Ia/In della coppia di spunto Ca/Cn e della coppia massima Cmax/Cn.

Where you can notice (\*) that a motor wound at 50 Hz can work at 60 Hz with the same rated voltage, power [W], with a 1.2 increase of rpm and rated current in, also a 0.8 reduction of starting current Ia/In, of the starting torque Ca/Cn and of the maximum torque Cmax/Cn.

Den mit einem Sternchen (\*) markierten Zeilen kann entnommen werden, daß ein für 50 Hz ausgelegter Motor bei 60 Hz betrieben werden kann mit gleichen Nennspannungen, gleicher Leistung [W], einer Steigerung der Drehzahl [rpm] und des Nennstroms [In] um den Faktor 1.2 und einer Verminderung um den Faktor 0.8 des Anlaufstroms [Ia/In], des Anzugmoments [Ca/Cn] und des Höchstmoments [Cmax/Cn].

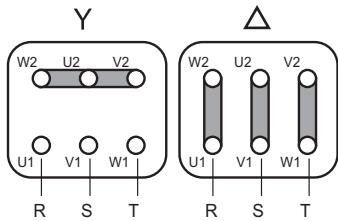
<b>Ia/In =</b>	Corrente di spunto Corrente nominale	<i>Starting current</i> <i>Rated current</i>	Anlaufstrom Nennstrom
<b>Ca/Cn =</b>	Coppia di spunto Coppia nominale	<i>Starting torque</i> <i>Rated torque</i>	Anlaufmoment Nennmoment
<b>Cmax/Cn =</b>	Coppia massima Coppia nominale	<i>Maximum torque</i> <i>Rated torque</i>	Maximales Drehmoment Nennmoment
<b>In =</b>	Corrente nominale	<i>Rated current</i>	Nennstrom

Schemi di collegamento di motori trifase

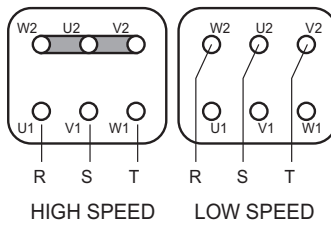
Three-phase motor wiring diagrams

Anschlusspläne für Drehstrommotoren

T-H-HA-I-IA-R-RA-S-SA

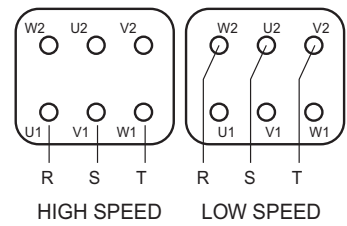


D-DA 2/4 - 4/8



Unico avvolgimento  
Single winding  
Einlagige Wicklung

D-DA 4/6-2/6-2/8-2/12



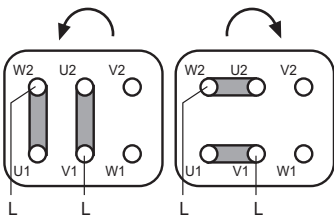
Doppio avvolgimento  
Double winding  
Doppellagige Wicklung

Schemi di collegamento di motori monofase

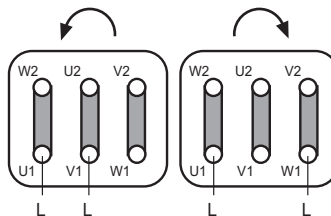
Single-phase motor wiring diagrams

Anschlusspläne für Einphasenmotoren

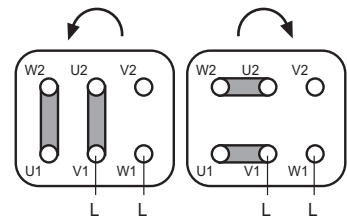
M-MC-ME



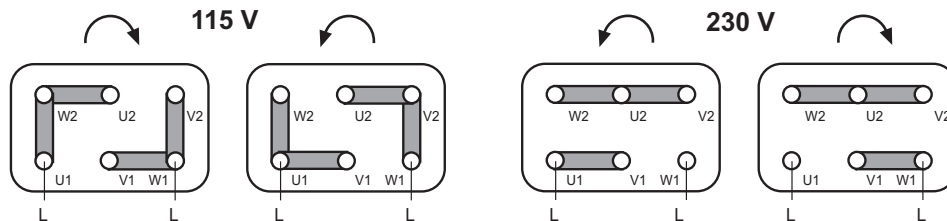
AE



MR



MF



Sensi di rotazione lato presa di forza  
Rotation sense understood from drive end  
Dreh Sinn auf der Abtriebsseite

Coprimorsettiera

Il coprimorsettiera è in alluminio pressofuso in esecuzione standard nella versione monoblocco IP55, a richiesta versione a due componenti in IP65, versione a due componenti da motori autofrenanti in IP65 di dimensione maggiorata..

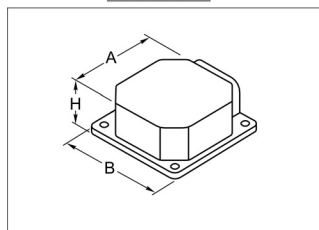
Terminal box

Made of die-cast aluminum in the standard version, as a single unit at IP55. Available upon request in the two-component version for selfbraking motors at IP65 in enlarged size.

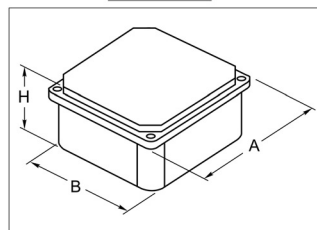
Klemmenkasten

In der Monoblock- Standardausführung gemäß Schutzart IP55 ist er aus Aluminium-Preßguß. Auf Wunsch ist er auch zweiteilig gemäß IP65 und für Bremsmotoren vergrößert, ebenfalls gemäß IP65, lieferbar. Für aggressive Milieus steht eine Plastikausführung gemäß IP55 zur Verfügung.

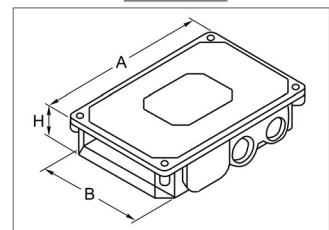
IP55



IP65



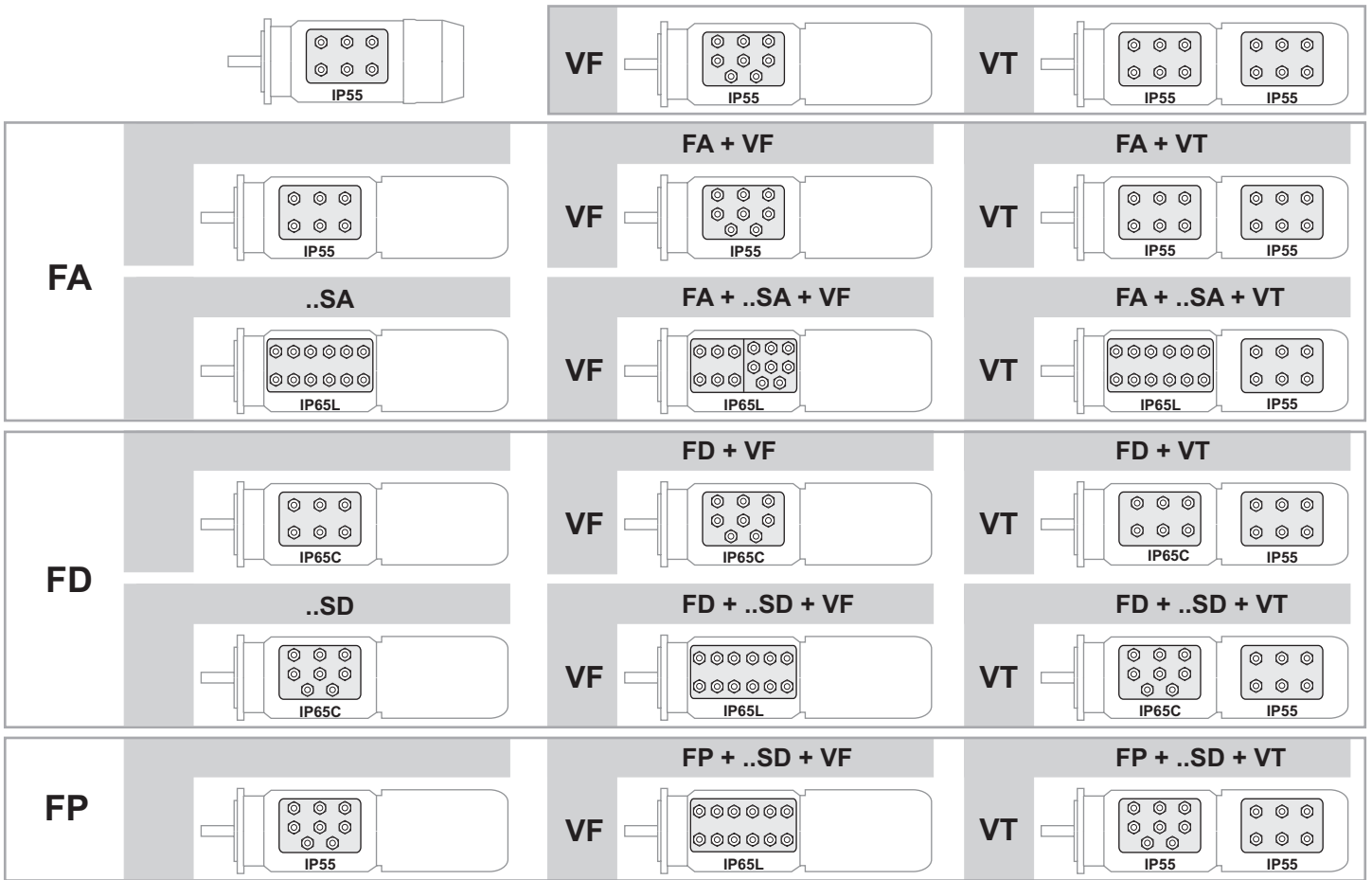
IP65L



Size	A	B	H	A	B	H	A	B	H
50				56	53	30			
56-71	66	76	34	93	85	47	137	84	40
80-112	78	91	40	110	102	58	153	100	46
132	92	105	46	123	102	63			
160				185	172	73			

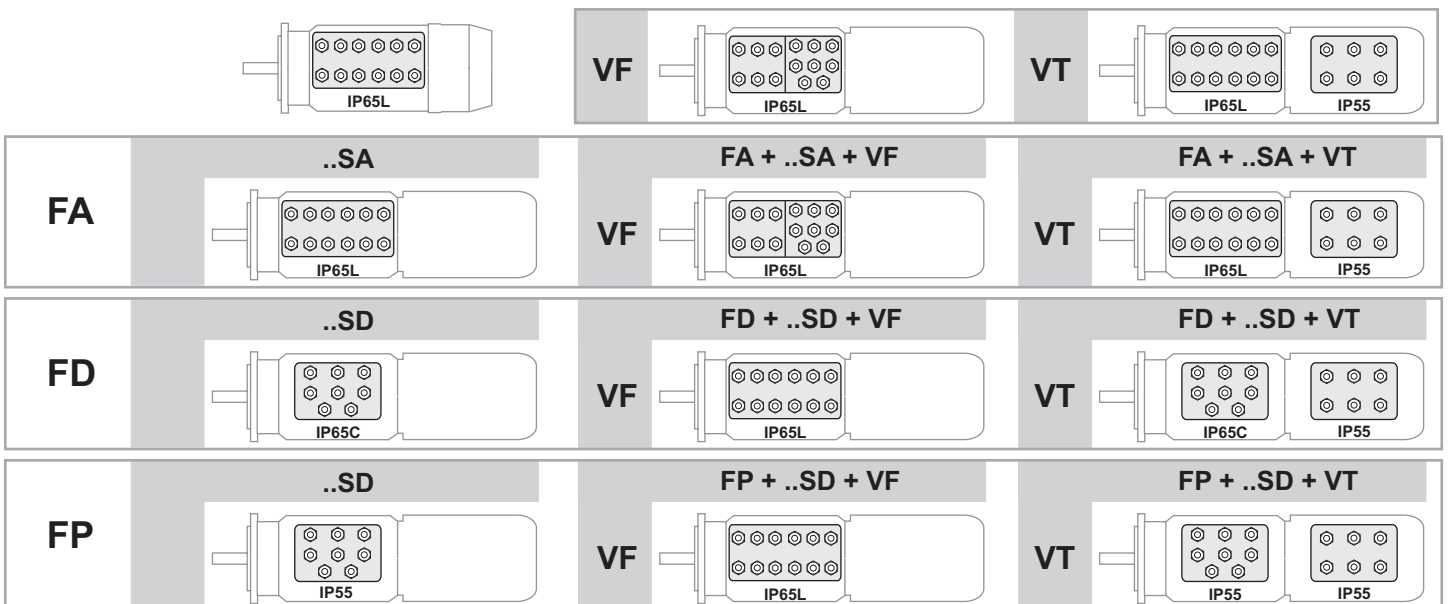
TRIFASE / THREE-PHASE / DREHSTROM  
MONOFASE / SINGLE PHASE / EINPHASEN

T - H - I - R - S  
M - MC - MR - ME



TRIFASE DOPPIA POLARITA' / THREE-PHASE DUAL POLARITY / DREHSTROM POLUMSCHALTBAR  
MONOFASE / SINGLE PHASE / EINPHASEN

D - DA  
M - MDA



## 1.5 OPZIONI

**Tropicalizzazione** (secondo CEI EN 60034-1/IEC 34-1)

Se i motori vanno installati all'aperto o in ambienti con alto tasso di umidità > 60% (U.R.), si esegue su richiesta un processo di tropicalizzazione degli avvolgimenti tramite verniciatura a freddo con prodotto di elevate qualità igroscopiche che protegge il motore dalla penetrazione della condensa nei materiali isolanti, evitando di pregiudicare la buona tenuta isolante.

**Fori per scarico condensa**

Su richiesta si eseguono fori di scarico condensa chiusi da tappi che verranno tolti una volta posti in servizio i motori

**Scaldiglia anticondensa** (secondo CEI EN 60034-1/IEC 34-1)

Su richiesta è possibile, in quelle applicazioni nelle quali la temperatura ambiente è estremamente bassa (0 °C), o dove il tasso di umidità è elevato > 60% (U.R.), installare sulle testate degli avvolgimenti una resistenza speciale di preriscaldamento della macchina quando questa non è funzionante.

In questo modo si evita che le parti meccaniche quali i cuscinetti o gli isolamenti vengano danneggiati dalle basse temperature.

Le potenze riscaldanti della scaldiglia sono in funzione della grandezza di motore, le tensioni a.c. di alimentazione sono a richiesta.

I terminali sono liberi o, su richiesta, fissati in morsettiere.

## 1.5 OPTIONS

**Tropicalization** (in accordance with CEI EN 60034-1/IEC 34-1)

*If the motors are installed outdoors or in rooms with a high percentage of humidity > 60% (R.H.), upon request a tropicalization treatment can be carried out on the windings by cold painting with a product having high hygroscopic qualities which protects the motor from condensation penetrating the insulating material, thereby compromising effective insulation.*

**Drain holes for condensation**

*On request, drain holes for condensation closed with plugs can be supplied which can be removed once the motors have been put into service.*

**Anti-condensation heater per CEI EN 60034-1/IEC 34-1**

*In applications where the ambient temperature is extremely low (0 °C) or where the humidity is high (> 60% R.H.), it is possible to install a special pre-heating element on the winding heads for the machine when not running.*

*This prevents mechanical parts such as bearings or isolations from being damaged by low temperatures.*

*The heating power of the heater depends on the motor size; AC supply voltages upon request.*

*The terminals are free or fixed to the terminal board upon request.*

## 1.5 OPTIONEN

**Tropfenfestigkeit** (gemäß CEI EN 60034-1/IEC 34-1)

Wenn die Motoren im Freien oder in Umgebungen mit hohem Feuchtigkeitsgehalt > 60 % (rel. F.) installiert werden, können auf Anfrage die Wicklungen durch eine spezielle Kaltlackierung mit einem stark hygroskopischen Produkt tropfenfest ausgelegt werden, das den Motor vor dem Eindringen von Kondenswasser in die Isolierstoffe schützt und die Beeinträchtigung der Isolierdichtigkeit verhindert.

**Kondenswasserabflusslöcher**

Auf Anfrage werden Kondenswasserabflusslöcher ausgeführt. Diese werden von Stopfen verschlossen, die nach Installation der Motoren entfernt werden.

**Wicklungsheizung** (nach CEI EN 60034-1/IEC 34-1)

Bei Motoren, die in Umgebungen mit besonders niedrigen Temperaturen (0° C) oder extrem hoher relativer Luftfeuchtigkeit (> 60%) betrieben werden, kann auf Wunsch an den Wicklungsköpfen ein besonderes Heizelement eingebaut werden. Dieses Heizelement sorgt dafür, daß der Motor während des Stillstands vorgewärmt wird. Damit soll eine Beschädigung der mechanischen Teile wie Lager und Isoliermaterial durch zu niedrige Temperaturen vermieden werden. Die Leistung der Wicklungsheizung wird auf die Größe des Motors ausgelegt.

Die Wechselspannungen können gewählt werden.

Die Kabelenden sind frei oder werden auf Wunsch am Klemmbrett befestigt.

Tab.1.11

Grandezza motore Motor size Baugröße MEC-IEC	Potenza riscaldante Heating power Heizleistung	Alimentazione AC [V] AC [V] feed Gleichstromversorgung
50 ÷ 71	8	220*
80 ÷ 90	22	220*
100 ÷ 112	22	220*
132	40	220*
160	40	220*

\* altre tensioni a richiesta / \* other tensions upon request / \* andere Spannungen auf Anfrage



**Ventilazione** (secondo IEC 34-6 e CEI EN 60034-6)

Si ottiene tramite una ventola girante a pale radiali bidirezionale calettata sull'albero motore IC 41. Realizzata in Latamid 6 ha una elevata temperatura di funzionamento di 100 °C.

Per applicazioni con controlli elettronici quali inverter, è disponibile la servoventilazione assistita tramite motore ausiliario, tipo ventilazione IC416 anche in kit.



A richiesta è disponibile l'opzione SV che prevede la fornitura del motore privo di ventola.



Indicando la variante VM, verrà sostituita la ventola standard con una in metallo.



**Servoventilazione**

**Tensioni di alimentazione:**

VT: 230V / 400V ( 50Hz / 60Hz)

VF: 230V (50Hz / 60Hz)

**Classe di isolamento:**

IP 23 standard

IP 55 a richiesta

Per applicazioni con coppia nominale al di sotto della velocità a 50Hz del motore, si impone il montaggio della servoventilazione adeguata, in quanto troppe le variabili in gioco per la determinazione dei vari servizi termici possibili e quindi delle temperature raggiunte dai motori.

**Cooling** (in accordance with IEC34-6 and CEI EN 60034-6)

*This is obtained using a revolving valve with two-way radial blades coupled to the IC 41 motor shaft. Made in Latamid 6, it has a high operating temperature at 100°C.*

*For applications with electronic controls such as inverters, power cooling is available by means of an IC416 cooling type auxiliary motor, also available in kit form.*

*Upon request the SV option is available whereby the motor is supplied without a fan.*

*If the VM option is selected, the standard fan will be replaced with a metal one.*

**Belüftung** (gemäß IEC 34-6 und CEI EN 60034-6)

Die Belüftung wird mittels eines richtungs-umkehrbaren Lüfterrades mit Radialschaufeln ausgeführt, das auf die Motorwelle IC 41 aufgezogen wird. Das Lüfterrad besteht aus Latamid 6 und hat eine hohe Betriebstemperatur von 100°C.

Für Anwendungen mit elektronischen Überwachungen wie Inverter ist die Servobelüftung mit Hilfsmotor möglich, die dem Typ IC416 – auch als Kit erhältlich - entspricht.

Auf Anfrage ist die Option SV für die Lieferung des Motors ohne Lüfterrad erhältlich.

Unter Angabe der Variante VM wird das Lüfterrad in der Standardausführung gegen ein Lüfterrad aus Metall ausgewechselt.

**Power cooling**

**Supply voltages**

VT: 230V / 400V ( 50Hz / 60Hz)

VF: 230V (50Hz / 60Hz)

**Insulation class**

IP 23 standard

IP 55 upon request

*For applications with a rated torque below motor speed at 50 Hz, the appropriate power cooling must be mounted as there are too many variables involved to determine the various possible thermal duties, and thus the temperatures reached by the motors.*

**Servobelüftung**

**Versorgungsspannungen**

VT: 230V / 400V ( 50Hz / 60Hz)

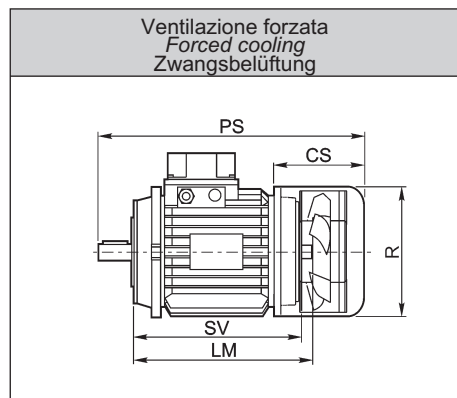
VF: 230V (50Hz / 60Hz)

**Isolierungsklasse**

IP 23 standard

IP 55 auf Wunsch

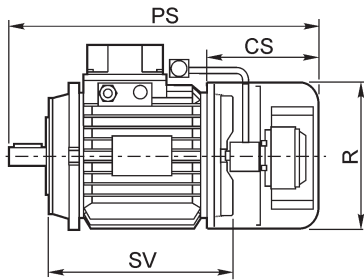
Bei Einsatz des Motors mit einem Nennmoment, das unter der Drehzahl für 50 Hz liegt, muß eine adäquate Servobelüftung vorgesehen werden, da die Anzahl der Variablen für die Bestimmung des thermischen Verhaltens und somit der vom Motor erreichten Temperaturen zu groß ist.



Tab.1.12

Grandezza Size Baugröße	R	CS	PS	SV	LM	PB [W]		VB [m <sup>3</sup> /min]
<b>50A</b>	104	—	—	103	116	—	—	—
<b>50B</b>	104	—	—	116	133	—	—	—
<b>56</b>	110	90	229	142	158	V 220	15	0.7
<b>63</b>	123	102	261	161	178	V 220	17	2.6
<b>71</b>	140	95	274	182	202	V 220	17	2.6
<b>80</b>	159	100	305	199	222	V 220	42	5.4
<b>90S</b>	176	95	320	210	238	V 220	42	5.4
<b>90L</b>	176	95	343	235	262	V 220	42	5.4
<b>100</b>	195	125	402	263	289	V 220	42	5.4
<b>112</b>	219	175	402	276	310	V 220	42	5.4
<b>132S</b>	258	220	565	315	350	V 220	42	5.4
<b>132M</b>	258	220	606	350	385	V 220	42	5.4
<b>160M</b>	315	260	735	423	458	V 220	115	26.8
<b>160L</b>	315	260	770	467	502	V 220	115	26.8

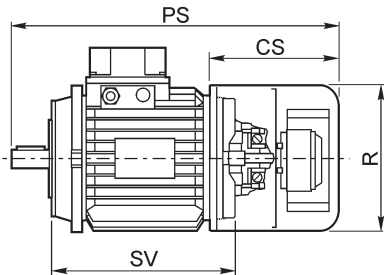
Ventilazione forzata e encoder  
Forced cooling and encoder  
Zwangsbelüftung und Encoder



Tab.1.13

Grandezza Size Baugröße	R	PS	CS	SV	PB [W]		VB [m <sup>3</sup> /min]
50A	104	—	—	103	—	—	—
50B	104	—	—	116	—	—	—
56	110	232	—	142	V 220	15	0.7
63	123	299	146	157	V 220	17	2.6
71	138	350	175	166	V 220	17	2.6
80	156	377	175	191	V 220	42	5.4
90S	176	366	140	219	V 220	42	5.4
90L	176	462	140	234	V 220	42	5.4
100	195	420	155	263	V 220	42	5.4
112	220	470	—	280	V 220	42	5.4
132S	258	562	220	315	V 220	42	5.4
132M	258	604	220	352	V 220	42	5.4
160M	315	735	—	423	—	115	26.8
160L	315	770	—	467	—	115	26.8

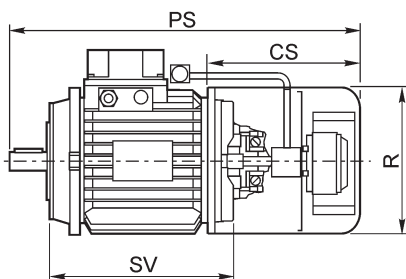
Freno e ventilazione forzata  
Brake and forced cooling  
Bremse und Zwangsbelüftung



Tab.1.14

Grandezza Size Baugröße	R	PS	CS	SV	PB [W]		VB [m <sup>3</sup> /min]
50A	104	—	—	103	—	—	—
50B	104	—	—	116	—	—	—
56	110	232	—	142	V 220	15	0.7
63	123	300	146	157	V 220	17	2.6
71	138	341	162	163	V 220	17	2.6
80	156	377	175	196	V 220	42	5.4
90S	176	401	183	275	V 220	42	5.4
90L	176	462	220	234	V 220	42	5.4
100	195	442	155	261	V 220	42	5.4
112	220	470	—	280	V 220	42	5.4
132S	258	610	265	316	V 220	42	5.4
132M	258	603	—	350	V 220	42	5.4
160M	315	735	—	423	—	115	26.8
160L	315	770	—	467	—	115	26.8

Ventilazione forzata con encoder e freno  
Forced cooling with encoder and brake  
Zwangsbelüftung mit Encoder und Bremse



Tab.1.15

Grandezza Size Baugröße	R	CS	PS	SV	PB [W]		VB [m <sup>3</sup> /min]
50A	104	—	—	103	—	—	—
50B	104	—	—	116	—	—	—
56	110	—	—	142	V 220	15	0.7
63	123	—	—	159	V 220	17	2.6
71	138	176	351	166	V 220	17	2.6
80	156	290	410	195	V 220	42	5.4
90S	176	220	436	219	V 220	42	5.4
90L	176	244	486	234	V 220	42	5.4
100	195	—	—	263	V 220	42	5.4
112	220	220	516	276	V 220	42	5.4
132S	258	—	—	315	V 220	42	5.4
132M	258	—	—	350	V 220	42	5.4
160M	315	—	—	423	—	115	26.8
160L	315	—	—	467	—	115	26.8



**Encoder**

Sono possibili esecuzioni speciali di alberi a richiesta predisposti, o su disegno per ricevere il dispositivo di misura della velocità o posizione, e per il calettaggio dello stesso sullo scudo motore.

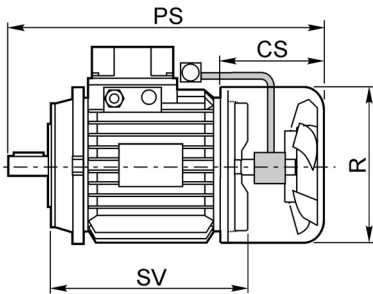
In questo caso, si può anche avere la servoventilazione assistita, sostenuta con staffe sul copriventola.

**Encoder**

*Special shaft configurations are available upon request, prepared or based on drawings to receive the speed or position measuring device, or for keying onto the motor shield. In this case, assisted power cooling is also available, supported by brackets on the fan cover.*

**Encoder**

Auf Wunsch sind Sonderwellen, auch nach Kundenzeichnung, lieferbar, die auf den Einbau von Drehzahl- oder Positionsmeßvorrichtungen und die Anbringung dieser Vorrichtungen am Lagerschild des Motors vorbereitet sind. In diesem Fall ist auch ein zusätzlicher Servolüfter lieferbar, der mit Klammern an der Lüfterhaube befestigt wird.



Tab.1.16

Grandezza Size Baugröße	R	CS	PS	SV
50A	104	—	—	103
50B	104	—	—	116
56	110	90	229	142
63	123	102	261	159
71	140	95	274	182
80	159	100	305	198
90S	176	95	320	207
90L	176	95	343	237
100	195	125	402	263
112	219	175	402	280
132S	258	220	565	315
132M	258	220	606	350
160M	315	260	735	423
160L	315	260	770	467

	EH
Tensione di alimentazione / <i>Supply voltage</i> / Versorgungsspannung	5 / 8...24 V
Assorbimento a vuoto / <i>Absorption when empty</i> / Stromaufnahme bei Nulllast	max 100 mA
Max. frequenza di utilizzo / <i>Max. operating frequency</i> / Max. Arbeitsfrequenz	100 kHz
Risoluzione (con tacca di zero) / <i>Resolution (with zero notch)</i> / Auflösung (mit Nullmarke)	200-250-400-500-512-1000-1024-2000-2048 (imp/giro) / (imp/rev.) / (Imp/U)
Risoluzione (senza tacca di zero) / <i>Resolution (without zero notch)</i> / Auflösung (ohne Nullmarke)	2-4-7-10-12-25-30-60-100-360-600 (imp/giro) / (imp/rev.) / (Imp/U)
Grado di protezione / <i>Protection level</i> / Schutzart	IP54
Temperatura di funzionamento / <i>Operating temperature</i> / Betriebstemperatur	-10...+85 °C
Temperatura di immagazzinamento / <i>Storage temperature</i> / Lagertemperatur	-25...+85 °C
Peso / <i>Weight</i> / Gewicht	250 g

**BI** Opzione  
Option  
Option

### Albero bisporgente

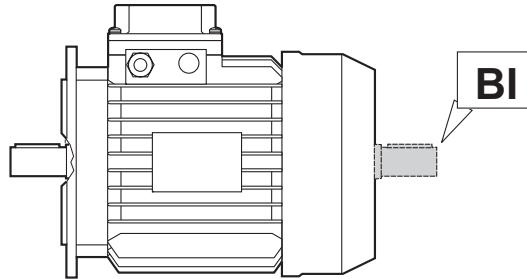
Il motore può essere fornito a richiesta con doppia estremità d'albero; le dimensioni sono disponibili nelle tabelle dimensionali. Non può essere fornito dove siano presenti le opzioni VF, VT, PP.

### Double ended shaft

*Upon request the motor can be supplied with a double ended shaft; the dimensions are shown in the size tables. It cannot be supplied where options VF, VT and PP are present.*

### Zweiseitige Welle

Der Motor kann auf Anfrage mit zweiseitig austretender Welle geliefert werden. Die Abmessungen sind in den Maßstabellen angegeben. Nicht lieferbar in Verbindung mit den Optionen VF, VT und PP.



### Protezioni termiche Standard TP111 (secondo IEC 34 - 11)

Le protezioni elettriche presenti sulla linea di alimentazione del motore possono essere insufficienti ad assicurare la protezione dai sovraccarichi. Infatti, se peggiorano le condizioni di ventilazione, il motore si surriscalda ma le condizioni elettriche non si modificano e ciò inibisce le protezioni sulle linee.

Si ovvia a questo inconveniente installando protezioni sugli avvolgimenti.

### Thermal overload cut-out switches-Standard TP111 (per IEC 34 - 11)

*The electrical protections on the motor power line may not be sufficient to protect against overloads. If the cooling conditions worsen, the motor overheats but the electrical conditions do not change, which inhibits line protections. Installing built-in protections on the windings solves this problem:*

### Standardüberhitzungsschutz TP111 (nach IEC 34 - 11)

Die in der Zuleitung des Motors vorhandenen Sicherungen gewährleisten nicht in allen Fällen einen ausreichenden Schutz vor Überlastungen. Wenn sich die Belüftung verschlechtert, wird der Motor zu heiß. Da jedoch keine Änderung der elektrischen Bedingungen erfolgt, werden die Sicherungen in der Zuleitung nicht angesprochen. Dieser Nachteil kann durch den Einbau von Schutzeinrichtungen an der Wicklung vermieden werden.

**TO** Opzione  
Option  
Option

### Dispositivo bimetallico PTO

è un dispositivo elettromeccanico che, normalmente chiuso, una volta raggiunta la temperatura di scatto si apre elettronicamente; si ripristina automaticamente quando la temperatura scende sotto il limite di scatto.

Sono disponibili bimetallici con diverse temperature di intervento e senza ripristino automatico, secondo EN-60204-1.

### Bimetallic device PTO

*this is a normally-closed electromechanical device that opens electrically when the threshold temperature is reached; it automatically resets when the temperature falls below the threshold level. Bimetallic devices are available with various intervention temperatures and without automatic reset, per EN 60204-1.*

### Bimetal-Schalter PTO

Es handelt sich um einen in Ruhestellung geschlossenen elektromechanischen Schalter, der sich bei Erreichen der Ansprechtemperatur automatisch öffnet. Bei Absenkung der Temperatur kehrt der Schaltkontakt selbständig in die Ruhestellung zurück. Die Bimetal-Schalter sind für verschiedene Ansprechtemperaturen und auf Wunsch auch ohne automatische Rückstellung, nach EN 60204-1 lieferbar.

**TC** Opzione  
Option  
Option

### Dispositivo termistore PTC

questo dispositivo varia la sua resistenza in modo repentino e positivo una volta raggiunta la temperatura di intervento.

### PTC thermistor device

*this device promptly, positively adjusts its resistance once the threshold temperature is reached.*

### PTC Thermistoren

Diese Vorrichtungen mit positivem Temperaturkoeffizienten sind in der Lage, ihren Widerstandswert beim Erreichen der Ansprechtemperatur plötzlich zu ändern.

**PP** Opzione  
Option  
Option

### Tettuccio parapioggia

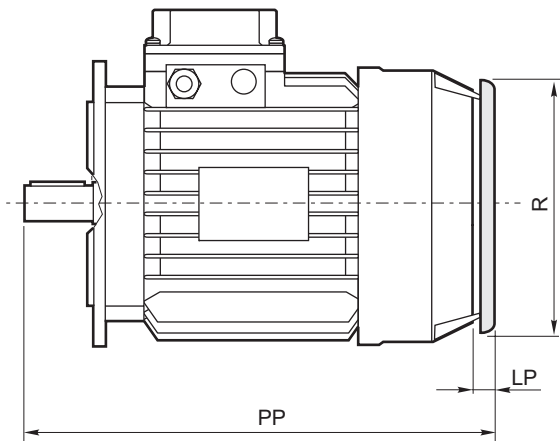
Per applicazioni esterne con montaggio in forma V5 - V3 - V19 - V15 - V18 - V1 - V36 - V6, è consigliabile montare un tettuccio parapioggia.

### Rain shield

For outdoor applications with V5 V3 - V19 - V15 - V18 - V1 - V36 - V6 installation (see Table 6), we recommend installing a rain shield. This configuration may also be used in the textiles processing industry.

### Regenschutzdach

Für Einsätze im Freien in den Einbaupositionen V5 - V3 - V19 - V15 - V18 - V1 - V36 - V6 (siehe Tab. 6) sollte ein Regenschutzdach verwendet werden. Das Regenschutzdach ist auch für Einsätze in der Textilverarbeitungsindustrie geeignet.



Tab.1.17

Grandezza Size Baugröße	PP	R	LP
56	209	110	22
63	238	123	22
71	267	140	22
80	297	159	22
90S	320	176	22
90L	348	176	22
100	390	195	22
112	410	219	26
132S	490	258	30
132L	517	258	30
160S	636	315	36
160L	690	315	36

**AE** Opzione  
Option  
Option

### Avvolgimento simmetrico

Avvolgimento bifase distribuito simmetricamente sulla circonferenza di macchina, fatto funzionare in regime monofase con condensatore sempre inserito.

E' usato dove è necessario invertire il senso di rotazione del motore in modo circuitale semplice.

In genere ha il funzionamento più silenzioso rispetto un avvolgimento monofase tradizionale, a scapito di una minore coppia di spunto % (-20%).

### Symmetrical winding

Two-phase winding distributed symmetrically around the machine circumference, run in single-phase mode with the capacitor always working.

This is used where it is necessary to reverse the motor rotation direction with simple circuits. It generally offers more noiseless operation than a traditional singlephase winding, though at the cost of reducing the starting torque (-20%).

### Symmetrische Wicklung

Es handelt sich dabei um eine am Motorumfang symmetrisch verteilte Zweiphasenwicklung, die im Einphasenbetrieb mit ständig angeschlossenem Kondensator verwendet wird.

Sie wird eingesetzt, wenn eine Umkehrung der Drehrichtung des Motors, ohne den Schaltkreis zu komplizieren, notwendig ist. Diese Wicklung ist geräuschärmer als die herkömmliche Einphasenwicklung, hat jedoch ein geringeres Anlaufmoment (-20%).

## 1.6 MOTORI ASINCRONI AUTOFRENANTI

### Generalità

Prevedono l'impiego di freni a pressione di molle, calettati saldamente su uno scudo in ghisa nella parte posteriore del motore. **Nei motori con freno FS lo scudo può essere in alluminio.**

L'azione frenante si manifesta in assenza di alimentazione alla bobina freno, siamo in presenza quindi di freni di sicurezza tranne freno positivo.

La classe di isolamento di questi freni è la "Classe F".

Tab.1.18

Freni disponibili	Brakes available	Erhältliche Bremsen		Pag./Seite
Freno in C.A.	AC Brake	Wechselstrombrems	<b>FA (FAM*)</b>	A42
Freno in C.C.	DC Brake	Gleichstrombremse	<b>FD (FDM*)</b>	A44
Freno di stazionamento	Parking brake	Haltebremse	<b>FS</b>	A46
Freno ad azione positiva	Positive action brake	Arbeitsstrombremse	<b>FP</b>	A48

\* Coppia di frenatura maggiorata / Increased braking torque / Erhöhtes Bremsmoment

Per quanto riguarda i motori, di tipo monofase, trifase e a doppia polarità, questi seguono fedelmente le caratteristiche già illustrate in questo catalogo dal punto di vista meccanico ed elettrico, ad esclusione dell'ingombro assiale, che aumenta per la presenza del freno.

La guarnizione di attrito (ferodo) dei nostri freni è priva di amianto, secondo le più recenti Direttive Comunitarie in materia di Igiene e Sicurezza del Lavoro.

Tutti i corpi freno sono protetti contro le aggressioni atmosferiche tramite verniciature e/o zincatura a caldo. Le parti più soggette ad usura sono trattate in atmosfere speciali che conferiscono proprietà notevoli di resistenza all'usura delle parti.

### Tensione di alimentazione

Per quanto riguarda le tensioni di alimentazione standard dei freni, queste sono 230/400 V  $\pm$  10%/50 Hz per freni trifase, mentre per freni in corrente continua sono di 230V  $\pm$  10% 50/60Hz dal lato A.C. dell'alimentatore freno. Infatti i freni in corrente continua necessitano di un alimentatore per funzionare su rete A.C.

### Ambiente di installazione

Il grado di protezione elettrica del freno è IP54 standard. Il grado di protezione meccanica del freno montato sul motore è IP54. Particolare attenzione deve essere posta nella scelta della protezione del freno, in funzione dell'ambiente di utilizzazione; infatti, in ambienti con acqua nebulizzata o molto umidi, o dove sono presenti polveri in atmosfera, o dove sono presenti atmosfere oleose, è obbligatorio il montaggio di protezioni meccaniche aggiuntive come successivamente specificato (anello antipolvere).

## 1.6 SELF-BRAKING

### General notes

*These use spring-pressure brakes, firmly spliced onto a cast iron shield at the back of the motor. In the S line, the shield may be aluminum.*

*The braking action appears in the absence of power supply to the brake coil; these are therefore safety brakes except positive brake.*

*The insulation class of these brakes is "Class F".*

*For single-phase, three-phase and dual-polarity motors, these faithfully follow the specifications already illustrated in this catalogue from a mechanical and electrical standpoint, with the exception of axial dimensions which increase due to the presence of the brake.*

*The lining of our brakes is asbestos-free, per the most recent EEC Directives in terms of Workplace Hygiene and Safety.*

*All brake assemblies are protected against atmospheric aggression by painting and/or heat galvanizing.*

*The parts most subject to wear are treated in special atmospheres that provide considerable wear resistance to the parts.*

### Supply voltage

*The standard supply voltages for the brakes are 230/400V V  $\pm$  10%/50 Hz for three-phase brakes, and 230V  $\pm$  10% 50/60 Hz for direct current brakes on the AC side of the brake power pack. Direct current brakes require a power pack in order to operate on an AC mains.*

### Installation site

*The standard electrical protection rating for the brake is IP54, while the mechanical protection for the brake installed on the motor is IP54. Choosing the brake protection requires special attention based on the user environment: in places with misted water or high humidity, where dust is present in the air, or where oily atmospheres are present, additional mechanical protections must be installed as specified below (dust protection ring).*

## 1.6 SELBSTBREMSENDE ASYNCHRONMOTOREN

### Allgemeine Angaben

Bei den Bremsmotoren werden Federdruckbremsen eingesetzt, die fest an einem Gußschild hinten am Motor verankert sind. **Bei der Serie S ist der Schild auch in Alu lieferbar.**

Die Bremsung wird ausgelöst, wenn die Bremsspule nicht mehr mit Strom versorgt wird. Es handelt sich also außer bei der Arbeitsstrombremse um eine Sicherheitsbremse. Die Isolationsklasse der Bremsen ist "F".

Die mechanischen und elektrischen Daten der Wechsel-, Drehstrom- und polumschaltbaren Bremsmotoren entsprechen denen der im Katalog aufgeführten Standardmotoren, jedoch nicht die Außenabmessungen, die durch die Bremse vergrößert sind. Die Reibbeläge unserer Bremsen entsprechen den neusten europäischen Gesundheits- und Arbeitsschutzvorschriften asbestfrei. Die Bremskörper sind durch Lack und/oder Warmverzinkung vor schädlichen Umwelteinflüssen geschützt. Die Verschleißteile werden besonderen Behandlungen unterzogen, um ihre Beständigkeit zu erhöhen.

### Speisespannung

Bei Drehstrombremsen ist die Standardspeisespannung der Bremsen 230/400 V  $\pm$  10%/50 bei 60 Hz. Die Gleichstrombremsen benötigen ein Netzgerät für den Anschluß an das Wechselstromnetz. Die Speisespannung beträgt 230 V V  $\pm$  10% bei 50/60 Hz an der Wechselstromseite des Netzgerätes der Bremse.

### Umfeld der Installation

Die Standardschutzart für die Elektrik und Mechanik der Bremse ist IP54. Die Schutzvorrichtungen der Bremse müssen mit besonderer Sorgfalt gewählt werden. In Umgebungen mit Sprühwasser, besonders hoher Feuchtigkeit, viel Staub oder ölhaltiger Luft müssen, wie nachfolgend aufgeführt, zusätzliche mechanische Schutzvorrichtungen (Staubschuttring) angebracht werden.

**Tempi di intervento dei freni D.C.**

Gli alimentatori possono essere scelti in funzione dei tempi di frenata desiderati. Infatti, a causa della rotazione inerziale del motore, i morsetti del freno ricevono energia anche dopo l'interruzione dell'alimentazione dalla rete (se collegati in morsetti). Questo comporta un tempo di ritardo della frenata che può risultare indesiderato. Per eliminare questo ritardo si ricorre all'interruzione del circuito di alimentazione freno direttamente sulla bobina dello stesso, impedendo così all'energia inerziale del motore di mantenere il freno in tensione. Si può quindi, dalle tabelle successive, effettuare la scelta dei tempi di frenata desiderati.

**Rumorosità**

I freni utilizzati per le grandezze di motore da noi prodotti rimangono ampiamente al di sotto dei limiti imposti dalle Direttive Comunitarie in materia di Protezione dei lavoratori contro i rischi di esposizione al rumore durante il lavoro. Tale limite si può sommariamente identificare in 140dB per pressione acustica istantanea non ponderata.

**DC brake intervention times**

*The power packs may be chosen based on the desired braking times. Due to the inertial rotation of the motor, the brake terminals receive energy even after the mains power supply is shut off (if connected via terminal board). This causes a braking delay that may be undesirable.*

*To eliminate this delay, the brake power supply circuit may be interrupted directly on its coil, thereby preventing the inertial energy of the motor from keeping the brake powered. The table below offers the parameters for choosing the desired braking times.*

**Noise levels**

*The brakes used for motor sizes we produce remain well within the limits set by the EEC Directives in terms of Worker Protection against the risk of exposure to noise at the workplace.*

*This limit may be briefly identified as 140 dB for non-weighted instantaneous acoustic pressure.*

**Betätigungszeiten der Gleichstrombremsen**

Bei der Wahl des Netzgerätes müssen die gewünschten Betätigungszeiten berücksichtigt werden. Durch das Nachlaufen des Motors werden die Klemmen der Bremse (falls sie im Klemmenkasten angeschlossen sind) auch nach Unterbrechung der Stromversorgung noch mit Strom versorgt. Dadurch wird die Bremsung verzögert. Um diese Verzögerung zu verhindern, wird die Stromversorgung der Bremse direkt an der Bremsspule unterbrochen, so daß die Bremse nicht mehr durch den Nachlaufstrom des Motors unter Spannung gesetzt wird. Aus den nachfolgenden Tabellen können die gewünschten Ansprechzeiten der Bremse gewählt werden.

**Geräuschpegel**

Der Geräuschpegel der für unsere Motoren verwendeten Bremsen liegt bei allen Bauformen unter den von den EG-Richtlinien für den Lärmschutz vorgeschriebenen Grenzwerten.

Die Grenzwerte sehen einen nicht gewichteten Schalldruckpegel von ca. 140 dB vor.

**Coppie frenanti maggiorate:**

è possibile, a richiesta, avere freni con coppie frenanti maggiorate, nelle tabelle dei dati tecnici dei freni sono riportate le coppie delle versioni maggiorate FAM e FDM.

**Increased braking torque:**

*upon request brakes with increased braking torque can be supplied, the brake technical specification tables show the torques of the updated versions FAM and FDM.*

**Höheres Bremsmoment:**

Auf Anfrage sind Bremsen mit erhöhtem Bremsmoment erhältlich. In den Tabellen mit den technischen Daten der Bremsen sind die Bremsmomente der momentgesteigerten Versionen FAM und FDM angegeben.

**OPZIONI FRENI / BRAKE OPTIONS / BREMSENOPTIONEN****Leva di sblocco manuale:**

consente, mediante lo spostamento della leva, in direzione lato copriventola del motore, lo sblocco del freno e la possibilità di manovra tramite chiave a brugola esagonale. Infatti, dal lato copriventola, è presente un foro passante che permette di raggiungere la testa dell'albero motore in cui è ricavato il foro esagonale di manovra. Essa può essere montata in 4 diverse posizioni come indicato nella seguente illustrazione.

**Hand release lever:**

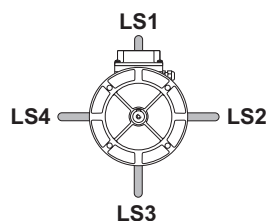
*moving the level towards the fan cover of the motor releases the brake, making it possible to use the hexagonal Allen wrench to move the unit. A through hole is available on the fan cover side to access the head of the motor shaft, containing the hexagonal movement hole.*

*It can be fitted in 4 different positions as shown in the following illustration.*

**Entsperrhebel**

Wenn man diesen Hebel in Richtung Lüfterhaube schiebt, wird die Bremse entriegelt und kann mit einem Inbusschlüssel betätigt werden. An der Seite der Lüfterhaube befindet sich eine durchgehende Bohrung, über die man an das Ende der Motorwelle gelangt, in der sich die Sechskantbohrung für die Betätigung der Bremse befindet.

Die Bremse kann in vier verschiedenen Einbautagen gemäß der nachstehenden Abbildung montiert werden.





### Alimentazione separata del freno:

si ottiene tramite una morsettiera ausiliaria, con fissati i morsetti delle bobine freno, posizionata all'interno del coprimorsettiera motore. Sono disponibili a richiesta coprimorsettiera maggiorati da autofrenanti IP65.

Nei motori doppia polarità autofrenanti, l'alimentazione separata è standard.

Tab.1.19

Tensioni di alimentazione speciali / <i>Special supply voltages are available upon request</i> Sonderspannungen		
	Tensioni A.C. AC voltages Wechselstromspannungen	Tensioni D.C. DC voltages Gleichstromspannungen
..SA	24-690 V 50/60 Hz	—
..SD	—	24-205 V 50/60 Hz



### Avviamento progressivo

Sono motori nei quali viene installata una ventola speciale in ghisa, che funge da volano energetico, ritardando al momento il raggiungimento della velocità di regime.

Questo perchè essendo l'energia cinetica del corpo ventola  $E_c = (1/2) J \omega^2$  [J], al momento dell'avviamento il motore deve spendere lavoro per avviare il volano supplementare e ciò implica l'impiego del tempo di avviamento a parità di tutte le altre condizioni.

Tab.1.20

Volani per motori / <i>Fly-wheels for motors</i> / Schwungräder für motoren		
Tipo / Type / Type	Peso volano / <i>Fly-wheel weight</i> / Gewicht Schwungrad (Kg)	Inerzia volano / <i>Fly-wheel inertia</i> / Trägheitsmoment Schwungrad (Kgm <sup>2</sup> )
71	0.525	0.00088
80	0.780	0.0019
90	0.840	0.0025
100 - 112	1	0.0034

### Gradi di protezione superiori:

Sono disponibili a richiesta due ulteriori gradi di protezione IP:

- il primo prevede l'utilizzo di un anello anti-polvere, di un disco in acciaio INOX, di un anello di tenuta, che porta il grado di protezione a IP 65, consigliato in ambienti polverosi e leggermente umidi UR < 60%.

- il secondo prevede l'utilizzo di una calotta in Alluminio con anello di tenuta che porta il grado di protezione a IP 56, consigliato in quegli ambienti dove è presente una forte umidità UR ≥ 60%, o sono presenti oli nebulizzati o getti d'acqua (tipici esempi sono macchine automatiche o macchine alimentari per il cui lavaggio si ricorre al getto in pressione d'acqua).

### Separate brake power supply:

*achieved by means of an auxiliary terminal board, with fixed brake coil terminals, located inside the motor terminal box. Increased terminal boxes for IP65 self-braking motors are available upon request.*

*Separate power supply is standard for dual-polarity self-braking motors.*

### Separate Stromversorgung der Bremse:

Die Bremse wird über ein zusätzliches Klemmbrett, an dem die Klemmen der Bremsenspule angeschlossen sind, mit Strom versorgt. Dieses Klemmbrett befindet sich im Klemmenkasten des Motors. Auf Wunsch sind größere Klemmenkästen (Ausführung wie für die Bremsmotoren) in IP 65 lieferbar.

Bei polumschaltbaren Bremsmotoren wird die separate Stromversorgung der Bremse serienmäßig eingebaut.

### Progressive starting

*These are motors in which a special cast-iron fan is installed, which acts as an energy catalyst, delaying the standard speed at start-up time. Since the kinetic energy of the fan assembly  $E_c = (1/2) J \omega^2$  [J], during start-up the motor must work to start the supplementary flywheel; this involves using the starting time with all other conditions being equal.*

### Anlaufverzögerte Motoren

Es handelt sich um Motoren, die über ein spezielles Lüfterrad aus Gußeisen verfügen. Das Lüfterrad übernimmt die Funktion eines Schwungrads und zögert beim Anlaufen des Motors das Erreichen der Betriebsdrehzahl hinaus. Da die kinetische Energie des Lüfterradkörpers  $E_c = (1/2) J \omega^2$  [J] ist, muß der Motor beim Starten zusätzliche Energie aufbringen, um das Schwungrad in Bewegung zu setzen. Dadurch wird die Anlaufzeit verlängert, alle anderen Bedingungen bleiben jedoch gleich.

### Increased protection levels:

*We can supply other two protection levels, available upon request.*

*- The first one needs a seal that protects totally against dust, an Inox disc, an oil seal, that all together bring the protection level to IP 65, which should be used in very dusty and slightly humid areas, RH<60%.*

*- The second needs an Aluminium calotte with an oil seal which bring the protection to IP 56, advised for areas where the humidity is very high R.H. ≥ 60%, or where there are water jets and nebuloused oil. (typical examples are automatic machines or food machines cleaned by using water sprayed under pressure).*

### Höhere Schutzart:

Auf Wunsch sind zwei weitere Schutzarten verfügbar.

- Die erste Schutzart sieht den Einsatz eines Staubschutzringes, einer Edelstahlscheibe und eines Dichtungsringes vor, womit die in staubiger und schwach feuchter Umgebung (relative Luftfeuchtigkeit < 60%) empfohlene Schutzart IP65 erreicht wird.

- Die zweite Schutzart sieht eine Aluminiumkappe mit Dichtungsring vor, womit die in sehr feuchten Umgebungen (relative Luftfeuchtigkeit ≥ 60%) oder in Umgebungen mit ölhaltiger Luft oder Spritzwasser empfohlene Schutzart IP56 erreicht wird. (wie z.B. bei automatischen Maschinen oder Lebensmittelmaschinen, die mit Wasser abgespritzt werden).



## Scelta del freno

### Calcolo interventi a carico possibili:

si considerano il numero di avviamenti possibili a vuoto  $Z_0$ , riportati nelle tabelle riguardanti le caratteristiche dei motori, per rimanere nei limiti di sovratemperatura, imposta dalla classe di isolamento del freno "IC.F", e sovratemperatura massima ammissibile per il mantenimento della coppia frenante nominale dalla guarnizione di attrito (ferodo), si ricavano il numero di avviamenti orari a carico dalla seguente formula sperimentale:

$$Z_c = Z_0 \cdot \xi \cdot \gamma$$

dove  $\xi$  e  $\gamma$  si ricavano dai grafici sperimentali seguenti in funzione rispettivamente, dalle coppie [Nm] e dalle masse [kg] in questione.

Infatti il coefficiente adimensionale  $\gamma$  è funzione del rapporto fra i momenti di inerzia del carico applicato  $J_c$  [kg m<sup>2</sup>] e delle masse rotanti del motore primo  $J_m$  [kg m<sup>2</sup>]  $\gamma = f(J_c/J_m)$ , mentre il coefficiente adimensionale  $\xi$  è funzione del rapporto fra la coppia resistente  $C_r$  [Nm] e la coppia di avviamento del motore primo  $C_a$  [Nm],  $\xi = f(C_r/C_a)$ .

Dove:

**Jc** = momento di inerzia del carico [kg m<sup>2</sup>]

**Jm** = momento di inerzia del motore primo [kg m<sup>2</sup>]

**Cr** = coppia resistente del carico [Nm]

**Ca** = coppia di avviamento del motore [Nm]

$\gamma = f(J_c/J_m)$

$\xi = f(C_r/C_a)$

## Choosing the brake

### Calculating possible load thresholds:

*the number no-load starts possible is considered to be  $Z_0$ , listed in the motor specification tables to remain within the peak temperature limits posed by the "IC.F" insulation class of the brake, and the maximum peak temperature admissible for maintaining the rated braking torque of the lining. This makes it possible to determine the number of starts per hour under load through the following experimental formula:*

*where  $\xi$  and  $\gamma$  are determined from the following experimental graphs, based respectively on the torque [Nm] and mass [kg] in question.*

*The  $\gamma$ -dimensional coefficient is a function of the ratio between the inertia moments of the applied load  $J_c$  [kg m<sup>2</sup>] and the rotating masses of the first motor  $J_m$  [kg m<sup>2</sup>]  $\gamma = f(J_c/J_m)$ , while the a-dimensional coefficient  $\xi$  is a function of the ratio between the resistance torque  $C_r$  [Nm] and the starting torque of the first motor  $C_a$  [Nm]  $\xi = f(C_r/C_a)$ .*

Where:

**Jc** = load inertia moment [kg m<sup>2</sup>]

**Jm** = first motor inertia moment [kg m<sup>2</sup>]

**Cr** = resistance torque of the load [Nm]

**Ca** = starting torque of the motor [Nm]

$\gamma = f(J_c/J_m)$

$\xi = f(C_r/C_a)$

## Wahl der Bremse

### Berechnung der zulässigen Bremsfrequenz unter Last:

Damit die max zulässige Übertemperatur der Isolationsklasse "IC.F" der Bremse und die max. zulässige Übertemperatur der Beläge für die Erhaltung des Nennbremsmoments nicht überschritten wird muß man von der zulässigen Einschaltfrequenz  $\dot{u}$  des Motors ohne Last, die in den Tabellen der Motordaten angegeben ist, ausgehen. Die Einschaltfrequenz des Motors pro Stunde unter Last kann mit der folgenden Formel ermittelt werden:

wobei  $\xi$  und  $\gamma$  als Funktion der Drehmomente [Nm] bzw. der Massen [kg] aus den nachfolgenden graphischen Darstellungen entnommen werden können.

Der dimensionslose Koeffizient  $\gamma$  ist nämlich eine Funktion des Verhältnisses des Trägheitsmoments der Last  $J_c$  [kg m<sup>2</sup>] zu dem der rotierenden Massen des Motors  $J_m$  [kg m<sup>2</sup>]:  $\gamma = f(J_c/J_m)$ , während der dimensionslose Koeffizient  $\xi$  eine Funktion des Verhältnisses des Widerstandsmoments  $C_r$  [Nm] zum Anlaufmoment des Motors  $C_a$  [Nm] ist:  $\xi = f(C_r/C_a)$ .

Dabei ist:

**Jc** = Trägheitsmoment der Last [kg m<sup>2</sup>]

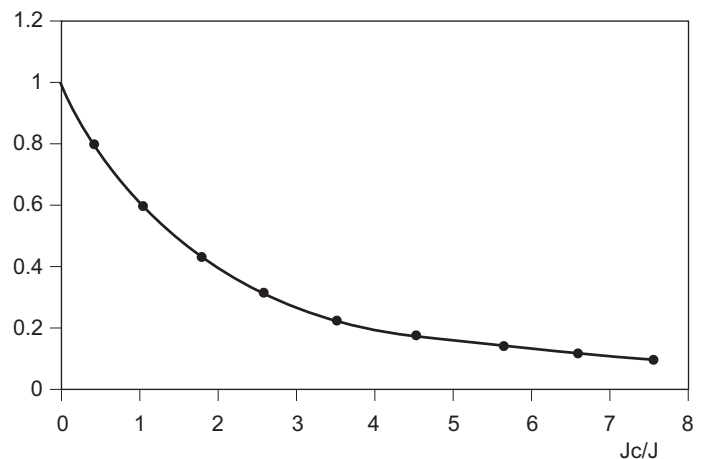
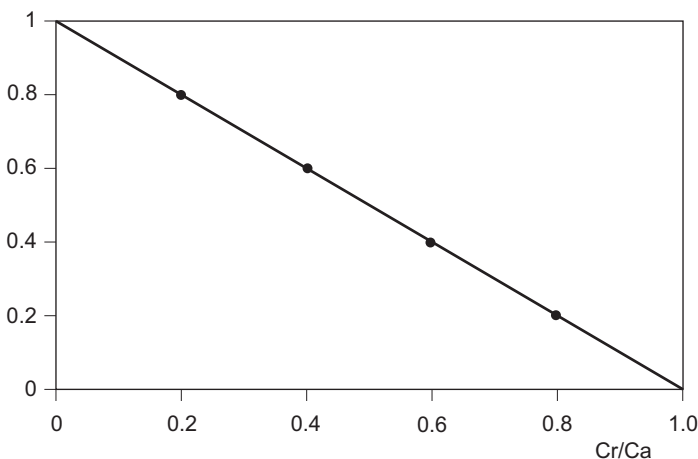
**Jm** = Trägheitsmoment des Motors [kg m<sup>2</sup>]

**Cr** = Widerstandsmoment der Last [Nm]

**Ca** = Anlaufmoment des Motors [Nm]

$\gamma = f(J_c/J_m)$

$\xi = f(C_r/C_a)$



Per masse con simmetria cilindrica il momento di inerzia  $J$  si calcola tramite la formula:

*For masses with cylindrical symmetry, the inertia moment  $J$  is calculated according to the formula:*

Für Massen mit zylindrischer Symmetrie wird das Trägheitsmoment mit der folgenden Formel berechnet:

$$J = (1/2) \cdot M \cdot (R^2)$$

dove  $M$  [kg] è la massa della massa rotante, mentre  $R$  [m] è il raggio del volume a simmetria cilindrica.

*where  $M$  [kg] is the mass of the rotating assembly, while  $R$  [m] is the radius of the cylindrical symmetry volume.*

wobei  $M$  [kg] die Masse des Drehkörpers und  $R$  [m] der Radius des Volumens mit zylindrischer Symmetrie ist.

Un classico esempio è quello del rotore e dell'albero di un motore elettrico asincrono. Se consideriamo i momenti di inerzia dell'albero  $J_1$  e del rotore  $J_2$ , questi si sommano algebricamente a ricavare il momento di inerzia totale  $J = J_1 + J_2$  [kg m<sup>2</sup>], in quanto ruotanti attorno il medesimo asse di rotazione. Se l'asse di rotazione non è il medesimo, esempio tipico delle pulegge e cinghie di trasmissione, è necessario considerare un termine di trasporto.

*A classical example is that of the rotor and shaft of an asynchronous electric motor. If we consider the inertia moments of the shaft  $J_1$  and the rotor  $J_2$ , these are added algebraically to determine the total inertia moment  $J = J_1 + J_2$  [kg m<sup>2</sup>] as they rotate around the same rotation axis. If the rotation axis is not the same (a typical example is that of transmission belts and pulleys), it is necessary to consider a transport end*

Ein klassisches Beispiel dafür ist der Läufer und der Welle eines Asynchronmotors. Wenn man das Trägheitsmoment der Welle  $J_1$  und des Läufers  $J_2$  berücksichtigt und algebraisch addiert, erhält man das Gesamtträgheitsmoment  $J = J_1 + J_2$  [kg m<sup>2</sup>], da sie sich um die gleiche Drehachse drehen. Wenn die Drehachse nicht dieselbe ist, wie zum Beispiel bei Riemenscheiben und Treibriemen, muß ein Transportterm berücksichtigt werden.

#### Calcolo del tempo di frenatura $t_f$ [s]

Per una determinazione indicativa del tempo di frenatura, si può fare uso della seguente formula:

#### Calculating the braking time $t_f$ [s]

*To arrive at an approximate braking time, the following formula may be used:*

#### Berechnung der Bremszeit $t_f$ [s]

Die ungefähre Bremszeit kann mit der folgenden Formel berechnet werden:

$$t_f = \frac{J_{tot} \cdot n}{9.55 (CF \pm Cr)} + t_B$$

dove:

$J_{tot}$  = Momento d'inerzia complessivo all'albero motore [kg m<sup>2</sup>]

$n$  = Velocità di rotazione motore [min<sup>-1</sup>]

$CF$  = Momento frenante [Nm]

$Cr$  = Momento resistente del carico applicato [Nm] con segno -i- se di segno concorde al momento frenante, - nel caso opposto

$t_B$  = Tempo di risposta elettrica del freno [s]

- 7 ms freno in A.C.

- 20 ms freno in D.C. (Rapida)

- 80 ms per freno D.C. (Normale)

where:

$J_{tot}$  = Overall inertia moment at the motor shaft [kg m<sup>2</sup>]

$n$  = Motor rotation speed [min<sup>-1</sup>]

$CF$  = Braking moment [Nm]

$Cr$  = Resistance moment of the applied load [Nm] with a + sign if the sign agrees with the braking moment, or - if not

$t_B$  = Electrical brake response time [s]

- 7 ms AC brake

- 20 ms DC brake (rapid)

- 80 ms for DC brake (normal)

Dabei ist:

$J_{tot}$  = Gesamtträgheitsmoment an der Motorwelle [kg m<sup>2</sup>]

$n$  = Drehgeschwindigkeit des Motors [min<sup>-1</sup>]

$CF$  = Bremsmoment [Nm]  $Cr$  = Widerstandsmoment der Last [Nm], positiv bei Übereinstimmung des Vorzeichens mit dem des Bremsmoment, negativ im gegenteiligen Fall

-  $t_B$  = elektrische Ansprechzeit der Bremse [s]

- 7 ms Wechselstrombremse

- 20 ms Gleichstrombremse (Schnellbremsung)

- 80 ms Gleichstrombremse (Normalbremsung)

Quindi si sceglierà il freno in funzione delle due variabili  $Z_c$  e  $t_f$ .

*Then select the brake based on the two variables  $Z_c$  and  $t_f$ .*

Die Bremse muß also unter Berücksichtigung der beiden Variablen  $Z_c$  und  $t_f$  gewählt.

Rodaggio ferodo

Il funzionamento nominale del freno si raggiunge dopo alcuni cicli di intervento, tali da permettere alla guarnizione di attrito di assestarsi.

*Lining break-in*

*The nominal brake operation is achieved after a few cycles, to allow the lining to settle.*

Einfahrzeit der Beläge

Die Bremse erreicht ihre Nennleistung erst nach einigen Bremszyklen, da sich die Bremsbeläge erst einfahren müssen.



## FRENO FA - FAM / FA – FAM BRAKE / BREMSE FA - FAM

**Freno elettromagnetico in corrente alternata.****Descrizione e funzionamento**

Freno elettromagnetico con funzionamento negativo (positivo a richiesta).

L'alimentazione della bobina freno è prevista nell'esecuzione standard con collegamento in morsettiera motore.

La tensione standard di alimentazione del gruppo freno è 230/400V  $\pm$ 10% 50Hz.

L'azione frenante si esercita in assenza di alimentazione; quando si interrompe l'alimentazione la bobina di eccitazione (1), non essendo più alimentata, non esercita la forza elettromagnetica necessaria a trattenere l'ancora mobile (2), la quale spinta dalle molle di pressione (14) comprime il disco (3) da una parte sulla flangia del motore, dall'altra sull'ancora stessa, esercitando così l'azione frenante.

**Regolazione**

Si possono effettuare due tipi diversi di regolazione:

**Regolazione del traferro**

Per un corretto funzionamento, il traferro S fra elettromagnete (1) e ancora mobile (2) deve essere compreso nei limiti di valori indicati in tabella (S<sub>nom</sub>-S<sub>max</sub>); la regolazione si effettua agendo sulle viti di fissaggio (10) e sui dadi di bloccaggio (11), controllando mediante spessimetro che sia raggiunto il valore di traferro desiderato S<sub>nom</sub>.

**Regolazione della coppia frenante**

Si ottiene agendo sulle viti senza testa (12), secondo le indicazioni della tabella (C<sub>n</sub> = coppia nominale -  $\Delta C$  = variazione coppia per un quarto di giro di vite).

In presenza di leva di sblocco manuale (5), una volta regolata la coppia frenante, occorre regolare la corsa libera della leva prima dell'inizio sblocco, agendo sui dadi di fissaggio della leva stessa.

**Electromagnetic brake in ac alternating current****Description and operation**

*Electromagnetic brake with negative operation (positive upon request).*

*The brake coil is powered through a connection to the motor terminal board in the standard version.*

*The standard supply voltage for the braking unit is 230/400V  $\pm$  10% 50 Hz.*

*The braking action is exercised in the absence of power supply. When the power supply is interrupted, the excitation coil (1) is no longer powered and therefore does not exert the magnetic force necessary to restrain the mobile armature (2) which, pushed by the pressure spring (14), compresses the brake disk (3) against the motor flange on one side and the armature itself on the other, thereby creating a braking action. .*

**Adjustment**

*Two different types of adjustment are possible.*

**Air gap adjustment**

*For proper operation, the air gap. S between the electromagnet (1 and the mobile armature (2) must be between the limits indicated in the table (S<sub>nom</sub>-S<sub>max</sub>); adjusting the holding screws (10) and nuts (11), using a thickness gauge to make sure that the desired air gap S<sub>nom</sub> is reached.*

**Braking torque adjustment**

*This is done using the headless screw (12) according to the instructions in the table (C<sub>n</sub> = rated torque;  $\Delta C$  = torque variation per one-quarter turn of the screw). If the hand release lever (5) is present, once the braking torque is adjusted it is also necessary to adjust the free stroke of the lever before release begins, using the holding data of the lever itself.*

**Elektromagnetische Wechselstrombremse****Beschreibung und Betrieb**

Die elektromagnetische Wechselstrombremse ist eine Ruhestrombremse (auf Wunsch als Arbeitsstrombremse lieferbar). In der serienmäßigen Ausführung wird die Zuleitung der Bremsspule am Klemmbrett des Motors angeschlossen. Die Standardspannung der Bremsgruppe ist 230/400 V  $\pm$  10% bei 50 Hz. Die Bremsung erfolgt bei fehlender Spannung.

Bei Unterbrechung der Stromversorgung übt die Erregerspule (1), da sie nicht mehr gespeist wird, keine Kraft mehr auf den mobilen Anker (2) aus. Dieser klemmt die Bremsscheibe (3) mit Hilfe der Druckfeder (14) zwischen dem Motorflansch (6) und sich selbst ein. Dadurch wird der Bremsseffekt erzielt.

**Einstellung**

Es können zwei verschiedene Einstellungen vorgenommen werden.

**Luftspalteinstellung**

Der Abstand des Luftspalts S zwischen dem Elektromagneten (1) und dem mobilen Anker (2) muß innerhalb der in der Tabelle angegebenen Werte (S<sub>nom</sub>-S<sub>max</sub>) liegen. Die Einstellung wird an den Befestigungsschrauben (10) und Blockiermutter (11) vorgenommen. Mit einer Lehre muß dann geprüft werden, ob der gewünschte S<sub>nom</sub>-Wert für den Luftspalt erreicht wurde.

**Einstellung des Bremsmoments**

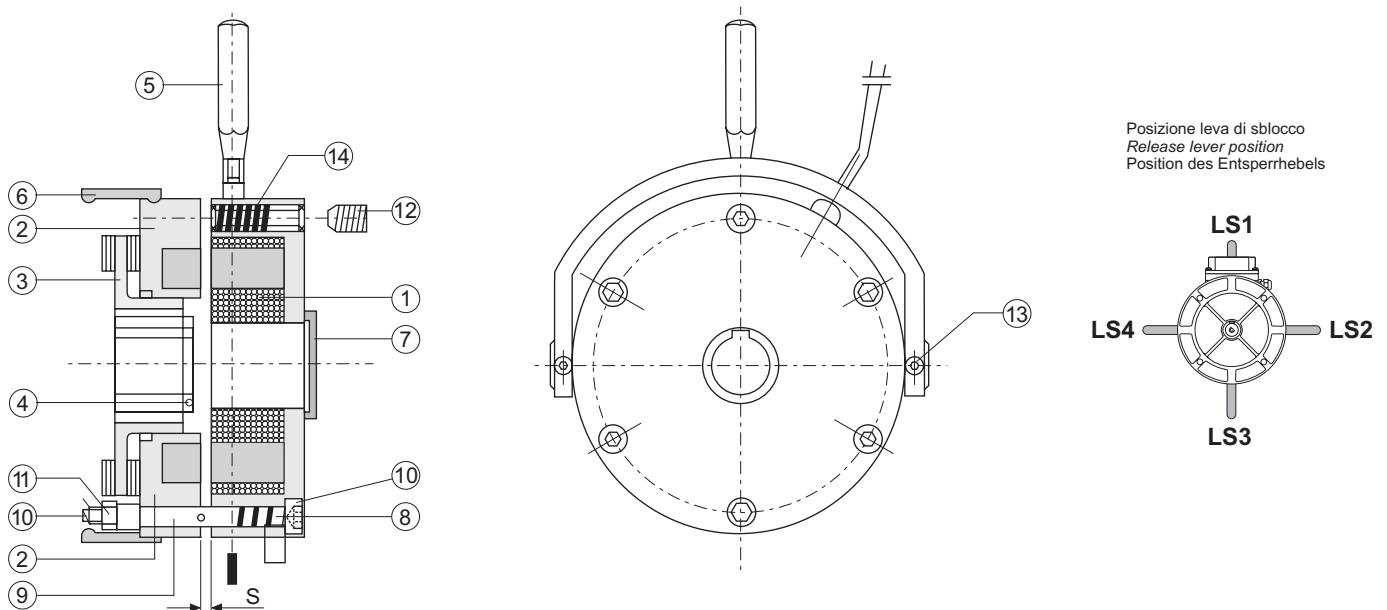
Die Einstellung des Bremsmoments wird an den Bolzen (12) unter Beachtung der in der Tabelle enthaltenen Angaben (C<sub>n</sub> = Nennmoment -  $\Delta C$  = Änderung pro Vierteldrehung des Bolzens) vorgenommen. Wenn der Entsperrhebel (5) eingebaut ist, muß, sobald das Bremsmoment eingestellt wurde, der freie Hebelweg vor der Entriegelung an den Hebelbefestigungsmuttern eingestellt werden.

## FRENO FA - FAM / FA – FAM BRAKE / BREMSE FA - FAM

Tab.1.20

Freno / Brake / Bremse	63	71	80	90	100	112	132	160	
Snom [mm]	0.3	0.3	0.3	0.35	0.35	0.35	0.4	0.4	
Smax [mm]	0.4	0.4	0.4	0.45	0.45	0.45	0.55	0.55	
CF [Nm]	FA	5	5	10	20	40	80	100	150
	FAM	—	10*	20*	40*	80*	100*	150*	—
Δ C [Nm]	—	—	—	—	—	—	—	—	
Tempo di frenata rapida [ms] Rapid braking time [ms] Schnellbremszeit [ms]	5	5	5	6	6	6	8	8	
Tempo di frenata super rapida [ms] Extra-rapid braking time [ms] Ultraschnellbremszeit [ms]	—	—	—	—	—	—	—	—	
Tempo di rilascio [ms] Release time [ms] Aufgenommene Leistung [ms]	20	20	35	60	90	90	100	150	
Potenza assorbita [W] Absorbed power [W] Aufgenommene Leistung [W]	18	18	25	30	35	35	40	60	
Rumore [dB] Noise level [dB] Geräuschpegel [dB]	37	37	39	40	42	42	45	47	

\* coppia frenante maggiorata per freno FAM / Braking torque increased for FAM brake / Bremsmomentsteigerung für die Bremse FAM



1	Elettromagnete	Electromagnet	Elektromagnet
2	Ancora mobile	Mobile armature	Mobiler Anker
3	Disco freno	Brake disc	Bremsscheibe
4	Trascinatore	Toothed hub	Mitnehmer
5	Leva di sblocco	Release lever	Entsperrhebel
6	Anello antipolvere	Dust protection ring	Staubschutzring
7	Anello di protezione IP65	IP55 protection	Schutzring nach IP65
8	Molla antagonista	Antagonist spring	Gegenfeder
9	Tubetto distanziale	Spacer tube	Abstandsrohr
10	Vite di fissaggio freno	Brake holding screw	Bremsenbefestigungsschraube
11	Dado di bloccaggio	Holding nut	Blockiermutter
12	Vite senza testa	Headless screw	Bolzen
13	Vite di fissaggio leva di sblocco	Release lever holding screw	Befestigungsschrauben des Entsperrhebels
14	Molla di pressione	Pressure spring	Druckfeder
S	Traferro	Air gap	Luftspalt

## FRENO FD - FDM / FD – FDM BRAKE / BREMSE FD – FDM

**Freno elettromagnetico in corrente continua****Descrizione e funzionamento**

Freno elettromagnetico con funzionamento negativo, la cui azione frenante si esercita in assenza di alimentazione; quando si interrompe l'alimentazione, la bobina di eccitazione (7), non essendo più alimentata, non esercita la forza magnetica necessaria a trattenere l'ancora mobile (1), la quale, spinta dalle molle di pressione (2), comprime il disco del freno (3) da una parte sulla flangia del motore (6), dall'altra sull'ancora stessa, esercitando così l'azione frenante. Variazione tensione d'alimentazione nominale freno consentita  $\pm 10\%$ .

**Regolazione**

Si possono effettuare due tipi diversi di regolazione.

**Regolazione del traferro**

Per un corretto funzionamento, il traferro S fra elettromagnete (7) e ancora mobile (1), dev'essere compreso nei limiti di valori indicati in tabella (Snom- Smax); la regolazione si effettua agendo sulle bussole filettate (12) controllando mediante spessimetro che si sia raggiunto il valore di traferro desiderato Snom.

**Regolazione della coppia frenante**

Si ottiene agendo sulla ghiera di regolazione (9), secondo le indicazioni della tabella ( $C_n$  = coppia nominale -  $\Delta C$  = variazione di coppia per dentatura). In presenza di leva di sblocco manuale (8), una volta regolata la coppia frenante, occorre regolare la corsa libera della leva prima dell'inizio sblocco, agendo sui dati di fissaggio della leva stessa.

**Tempo d'intervento freno**

In caso di freno in D.C. è possibile migliorare il tempo di frenata, interrompendo direttamente l'alimentazione del freno tramite interruttore.

**Electromagnetic brake in dc direct current****Description and operation**

*Electromagnetic brake with negative operation, whose braking action is exercised in the absence of power supply. When the power supply (7) is interrupted, the excitation coil is no longer powered and therefore does not exert the magnetic force necessary to restrain the mobile armature (1) which, pushed by the pressure spring (2), compresses the brake disk (3) against the motor flange (6) on one side and the armature itself on the other, thereby creating a braking action. The allowed rated supply voltage variation for the brake is  $\pm 10\%$ .*

**Adjustment**

*Two different types of adjustment are possible.*

**Air gap adjustment**

*For proper operation, the air gap S between the electromagnet (7) and the mobile armature (1) must be between the limits indicated in the table (Snom- Smax); adjust using the threaded bushes (12), using a thickness gauge to make sure that the desired air gap Snom is reached.*

**Braking torque adjustment**

*This is done using the adjuster ring (9) according to the instructions in the table ( $C_n$  = rated torque;  $\Delta C$  = torque variation per tooth). If the hand release lever (8) is present, once the braking torque is adjusted it is also necessary to adjust the free stroke of the lever before release begins, using the holding data of the lever itself.*

**Brake intervention time**

*For the DC brake, it is possible to improve the braking time by directly interrupting the brake power supply via the switch.*

**Elektromagnetische Gleichstrombremse****Beschreibung und Betrieb**

Die elektromagnetische Gleichstrombremse ist eine Ruhestrombremse, d.h. sie bremst bei fehlender Spannung. Bei Unterbrechung der Stromversorgung (7) übt die Erregerspule, da sie nicht mehr gespeist wird, keine Kraft mehr auf den mobilen Anker (1) aus. Dieser klemmt die Brems Scheibe (3) mit Hilfe der Druckfeder (2) zwischen dem Motorflansch (6) und sich selbst ein. Dadurch wird der Bremsseffekt erzielt. Die zulässige Abweichung von der Nennspannung beträgt  $\pm 10\%$ .

**Einstellung**

Es können zwei verschiedene Einstellungen vorgenommen werden.

**Luftspalteinstellung**

Der Abstand des Luftspalts S zwischen dem Elektromagneten (7) und dem mobilen Anker (1) muß innerhalb der in der Tabelle angegebenen Werte (Snom- Smax) liegen. Die Einstellung wird an den Gewindebuchsen (12) vorgenommen. Mit einer Lehre muß dann geprüft werden, ob der gewünschte Snom-Wert für den Luftspalt erreicht wurde.

**Einstellung des Bremsmoments**

Die Einstellung des Bremsmoments wird an der Einstellring (9) unter Beachtung der in der Tabelle enthaltenen Angaben ( $C_n$  = Nennmoment -  $\Delta C$  = Änderung pro Verzahnung) vorgenommen. Wenn der Entsperrhebel (8) eingebaut ist, muß, sobald das Bremsmoment eingestellt wurde, der freie Hebelweg vor der Entriegelung an den Hebelbefestigungsmuttern eingestellt werden.

**Ansprechzeit der Bremse**

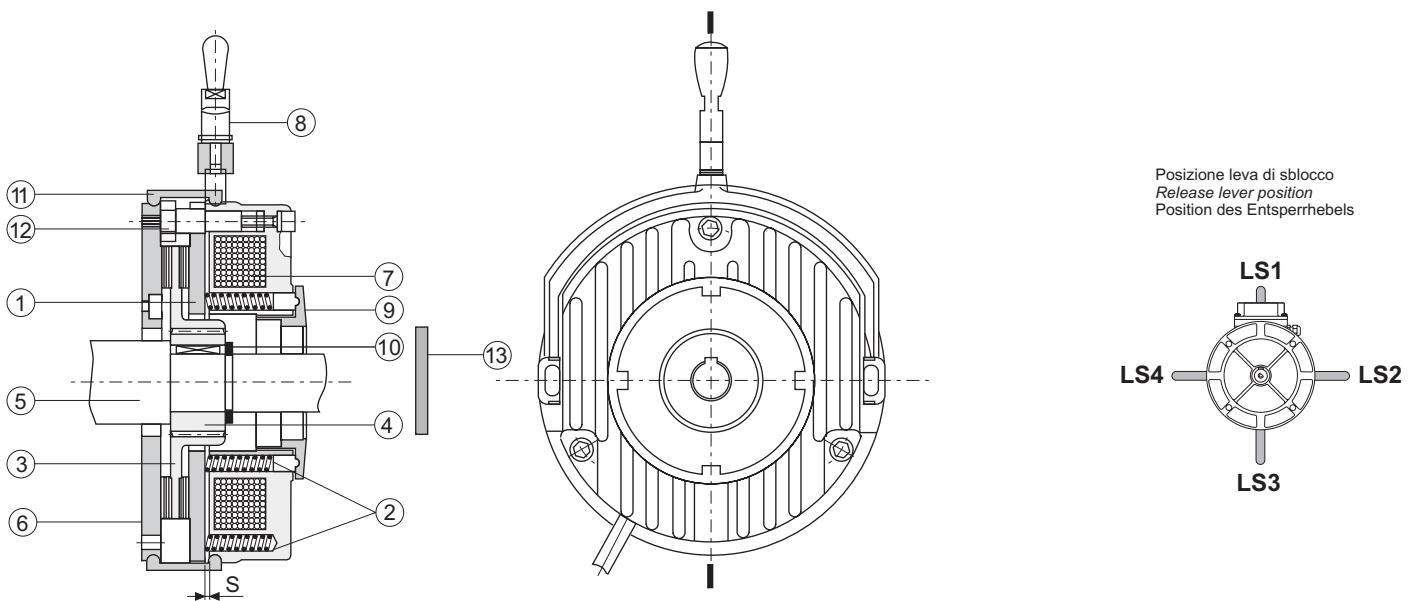
Bei Gleichstrombremsen kann die Ansprechzeit durch direkte Unterbrechung der Stromversorgung mittels Schalter verbessert werden.

## FRENO FD - FDM / FD – FDM BRAKE / BREMSE FD – FDM

Tab.1.22

Freno / Brake / Bremse	56	63	71	80	90	100	112	132	160
Snom [mm]	0015	0.2	0.2	0.2	0.2	0.3	0.3	0.3	0.4
Smax [mm]	—	0.5	0.5	0.5	0.5	0.7	0.8	1	1
CF [Nm]	FD	1	5	5	10	16	32	60	150
	FDM	—	—	10*	16*	32*	60*	80*	150*
Δ C [Nm]	—	0.1	0.1	0.36	0.6	1.2	1.5	2.1	2.1
Tempo di frenata rapida [ms] Rapid braking time [ms] Schnellbremszeit [ms]	30	45	50	70	90	120	180	210	230
Tempo di rilascio rapida [ms] Rapid release time [ms] Schnellbremslösezeit [ms]	12	15	30	35	50	65	75	90	110
Tempo di frenata extra rapida [ms] Extra-rapid braking time [ms] Ultraschnellbremszeit [ms]	20	25	30	40	45	60	110	140	180
Tempo di rilascio extra rapida [ms] Extra-rapid release time [ms] Ultraschnellbremslösezeit [ms]	8	12	20	25	35	45	60	70	90
Potenza assorbita [W] Absorbed power [W] Aufgenommene Leistung [W]	12	20	20	25	30	40	50	55	85
Rumore [dB] Noise level [dB] Geräuschpegel [dB]	39	36	36	37	37	38	38	39	42

\* coppia frenante maggiorata per freno FDM / Braking torque increased for FDM brake / Bremsmomentsteigerung für die Bremse FDM



Posizione leva di sblocco  
Release lever position  
Position des Entsperrhebels

1	Ancora mobile	Mobile armature	Mobiler Anker
2	Molle	Springs	Federn
3	Disco freno	Brake disc	Bremsscheibe
4	Trascinatore	Toothed hub	Mitnehmer
5	Albero motore	Motor shaft	Motorwelle
6	Flanfia motore	Motor flange	Motorflansch
7	Elettromagnete	Eletromagnet	Elektromagnet
8	Leva di sblocco	Release lever	Entsperrhebel
9	Ghiera di regolazione	Adjuster ring	Einstellring
10	Seeger	Seeger	Seeger-Ring
11	Anello antipolvere	Dust protection ring	Staubschutzring
12	Bussola filettata	Threaded bush	Gewindebuchse
13	Anello di protezione IP65	IP55 protection	Schutzring nach IP65
S	Traferro	Air gap	Luftspalt

## FRENO FS / BRAKE FS / BREMSE FS

**Freno elettromagnetico di stazionamento in C.C.****Descrizione e funzionamento**

Freno elettromagnetico con funzionamento negativo la cui azione frenante si esercita in assenza di alimentazione: se l'alimentazione dell'elettromagnete (1) è presente essendo l'ancora mobile(2) richiamata dalla forza magnetica, permette la rotazione libera dell'albero; quando si interrompe l'alimentazione, la bobina di eccitazione, non essendo più alimentata, non esercita la forza magnetica necessaria a trattenere l'ancora mobile (2), la quale spinta dalle molle di coppia (3) comprime la guarnizione di attrito, solidale con l'ancora mobile contro la ventola in ghisa (4), solidale con l'albero motore tramite la chiave (5), esercitando così l'azione frenante.

La tensione standard per questo tipo di freno è 230V/ 50Hz/60Hz con variazioni possibili del  $\pm 10\%$  del valore nominale di tensione.

**Regolazione traferro**

Per un corretto funzionamento, il traferro S [mm] fra elettromagnete (1) e ancora mobile (2) dev'essere compreso nei limiti dei valori indicati in tabella (Snom-Smax); la regolazione si effettua, una volta fissato saldamente il corpo freno al motore, agendo sulla vite (6), registrandola e controllando mediante spessimetro che si sia raggiunto il valore di traferro desiderato. Questa operazione va eseguita con freno a temperatura ambiente.

**Tempo di intervento freno**

In caso di freno in corrente continua, alimentato tramite un ponte di diodi in alternata, è possibile ottenere degli interventi superrapidi in frenata, tramite alimentatori speciali.

**DC electromagnetic parking brake****Description and operation**

*Electromagnetic brake with negative operation, whose braking action is exercised in the absence of power supply. If the electromagnet (1) is powered, the mobile armature (2) is drawn by the magnetic force and allows the shaft to rotate freely. When the power supply is interrupted, the excitation coil is no longer powered and therefore does not exert the magnetic force necessary to restrain the mobile armature (2). The latter, pushed by the pressure spring (3), compresses the lining attached to the mobile armature against the cast-iron fan (4), in turn attached to the motor shaft by the key (5), thereby creating a braking action. The standard voltage for this type of brake is 230V/50Hz/ 60Hz with possible variations of  $\pm 10\%$  in the rated voltage.*

**Air gap adjustment**

*For proper operation, the air gap S [mm] between the electromagnet (1) and the mobile armature (2) must be between the limits indicated in the table (Snom-Smax). Once the brake assembly is firmly attached to the motor, adjust using the screw (6), setting and checking with a thickness gauge to make sure that the desired air gap is reached. This should be done with the brake at ambient temperature.*

**Braking intervention times**

*For the direct current brake, powered by an alternating current diode jumper, it is possible to achieve extra-rapid braking intervention using special power packs.*

**Elektromagnetische Gleichstromfeststellbremse****Beschreibung und Betrieb**

Die elektromagnetische Gleichstromfeststellbremse ist eine Ruhestrombremse, d.h. sie bremst bei fehlender Spannung. Wenn der Elektromagnet (1) mit Strom versorgt wird, kann sich die Welle ohne Behinderung drehen, da die Kraft des Magneten den mobilen Anker (2) zurückhält. Bei Unterbrechung der Stromversorgung übt die Erregerspule, da sie nicht mehr gespeist wird, keine Kraft mehr auf den mobilen Anker (2) aus. Dieser drückt den an ihm befestigten Belag mit Hilfe der Drehmomentfeder (3) gegen das mit der Motorwelle verkeilte (5) Lüfterrad aus Guß (4). Dadurch wird der Bremsseffekt erzielt. Die Standardspannung für diese Art von Bremse beträgt 230V/50Hz/60Hz mit einer Toleranz von  $\pm 10\%$  der Nennspannung.

**Luftspalteinstellung**

Der Abstand des Luftspalts S [ mm] zwischen dem Elektromagneten (1) und dem mobilen Anker (2) muß innerhalb der in der Tabelle angegebenen Werte (Snom-Smax) liegen. Die Einstellung wird, sobald der Bremskörper am Motor befestigt wurde, an der Schraube (6) vorgenommen. Mit einer Lehre muß dann geprüft werden, ob der gewünschte Wert für den Luftspalt erreicht wurde. Bei dieser Einstellung muß die Bremse Umgebungstemperatur haben.

**Ansprechzeit der Bremse**

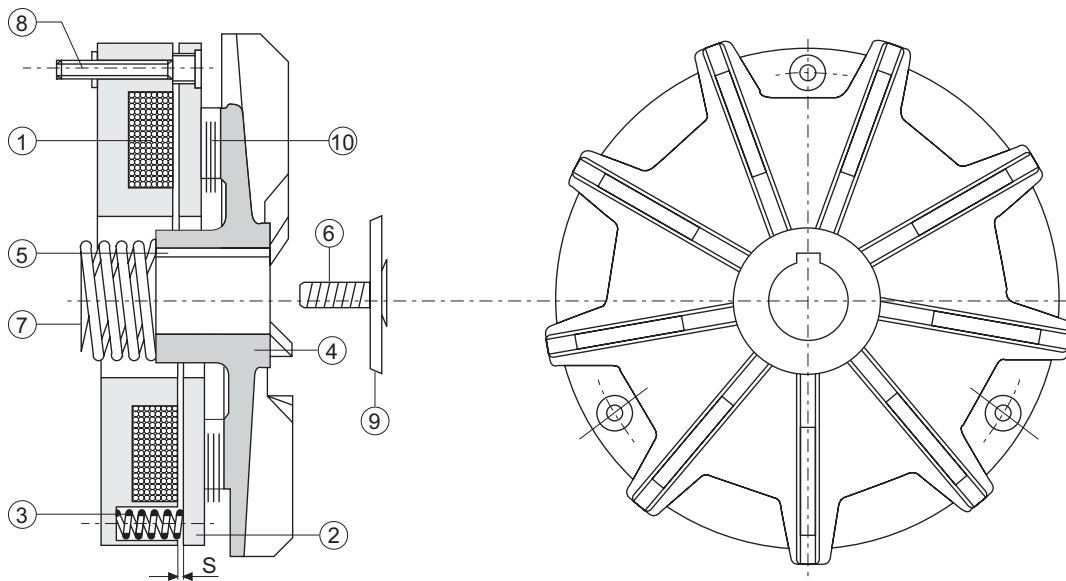
Bei Gleichstrombremsen, die über eine Diodenbrücke mit Wechselstrom gespeist werden, kann die Ansprechzeit durch den Einsatz von besonderen Netzteilen merklich verbessert werden (Ultraschnellbremsung).



**FRENO FS / BRAKE FS / BREMSE FS**

Tab.1.23

Freno / Brake / Bremse	63	71	80	90	100	112	132	160
Snom [mm]	0.2	0.2	0.2	0.2	0.3	0.3	0.3	0.5
Smax [mm]	0.4	0.4	0.4	0.5	0.5	0.7	0.7	0.8
CF [Nm]	4	4	8	8	11	11	17	25
Tempo di frenata rapida [ms] Rapid braking time [ms] Schnellbremszeit [ms]	40	100	120	120	200	200	200	215
Tempo di frenata super rapida [ms] Extra-rapid braking time [ms] Ultraschnellbremszeit [ms]	30	30	45	45	55	55	55	65
Tempo di rilascio [ms] Release time [ms] Aufgenommene Leistung [ms]	15	15	15	15	10	10	10	13
Potenza assorbita [W] Absorbed power [W] Aufgenommene Leistung [W]	17	17	34	34	40	40	40	45
Rumore [dB] Noise level [dB] Geräuschpegel [dB]	35.5	35.5	36	36	38	38	38	44.5



1	Elettromagnete	<i>Eletromagnet</i>	Elektromagnet
2	Ancora mobile	<i>Mobile armature</i>	Mobiler Anker
3	Molla di coppia	<i>Torque spring</i>	Dremomentfeder
4	Ventola in ghisa	<i>Cast-iron fan</i>	Lüfterrad aus Guß
5	Chiavetta	<i>Key</i>	Keil
6	Vite	<i>Screw</i>	Schraube
7	Molla di precario	<i>Pre-loading screw</i>	Vorspannfeder
8	Bussole filettate	<i>Threaded bushes</i>	Gewindebuchsen
9	Rondella	<i>Washer</i>	Unterlegscheibe
10	Guarnizione di frizione	<i>Clutch lining</i>	Bremsbelag
S	Traferro	<i>Air gap</i>	Luftspalt

## FRENO FP / BRAKE FP / BREMSE FP

**Freno elettromagnetico ad azione positiva in C.C.****Descrizione e funzionamento**

Freno elettromagnetico con funzionamento positivo la cui azione frenante si esercita in presenza di alimentazione: infatti, se l'alimentazione dell'elettromagnete (6) è assente, essendo l'ancora mobile (1) trattenuta dalla forza esercitata dalla molla anulare (4), permette la rotazione libera dell'albero (5).

Quando si alimenta la bobina di eccitazione (6), questa esercita la forza magnetica necessaria ad attrarre l'ancora mobile (1), la quale, vincendo la forza della molla anulare (4), impegna la guarnizione di attrito (3) solidale con lo statore; ancora essendo la (1) solidale con l'albero motore (5) tramite la chiavetta (8), esercita così l'azione frenante.

La tensione standard per questo tipo di freno è 24 V.D.C. con variazioni possibili ( $\pm 10\%$  del valore nominale di tensione).

Questo tipo di freno è isolato in classe "B".

**Regolazione traferro**

Per un corretto funzionamento, il traferro S [mm] fra statore elettromagnete [(3)+(6)] e ancora mobile (1), dev'essere compreso nei limiti di valori indicati in tabella (Snom-Smax); la regolazione si effettua, una volta fissato saldamente il corpo freno al motore, agendo sul dado autobloccante (7) registrazione traferro, e controllando mediante spessimetro che si sia raggiunto il valore di traferro desiderato.

Questa operazione va eseguita con freno a temperatura ambiente.

**Tempo di intervento freno**

In caso di freno in corrente continua, alimentato tramite un ponte di diodi in alternata, è possibile ottenere degli interventi super rapidi in frenata, tramite alimentatori speciali come indicato in tabella 24.

**DC electromagnetic positive-action brake****Description and operation**

Electromagnetic brake with positive operation, whose braking action is exercised in the presence of power supply. If the electromagnet (6) power supply is absent, the mobile armature (1) is drawn by the force exerted by the anular spring (4) and allows the shaft (5) to rotate freely.

When the excitation coil (6) is powered power, it exerts the magnetic force needed to attract the mobile armature (1). The latter overcomes the force of the anular spring (4) and engages the lining (3) attached to the stator, in turn (1) attached to the motor shaft (5) by the key (8), thereby creating a braking action.

The standard voltage for this type of brake is 24 VDC with possible variations of  $\pm 10\%$  in the rated voltage. This type of brake is insulated for class "B".

**Air gap adjustment**

For proper operation, the air gap S [mm] between the electromagnet stator [(3)+(6)] and the mobile armature (1) must be between the limits indicated in the table (Snom-Smax). Once the brake assembly is firmly attached to the motor, adjust using the self-locking air gap setting nut (7), checking with a thickness gauge to make sure that the desired air gap is reached. This should be done with the brake at ambient temperature.

**Braking intervention times**

For the direct current brake, powered by an alternating-current diode jumper, it is possible to achieve extra-rapid braking intervention using special power packs as indicated in the table 24.

**Elektromagnetische Arbeitsstrombremse für Gleichstrom****Beschreibung und Betrieb**

Dieelektromagnetische Gleichstrombremse ist eine Arbeitsstrombremse, d.h. sie bremst bei angelegter Spannung. Wenn der Elektromagnet (6) nicht mit Strom versorgt wird, kann sich die Welle (5) frei drehen, da die Kraft der Ringfeder (4) den mobilen Anker (1) zurückhält. Wenn die Erregerspule (6) mit Strom versorgt wird, zieht sie den mobilen Anker (1) durch ihre magnetische Kraft an. Dadurch überwindet der mobile Anker die Kraft der Ringfeder (4) und wirkt auf den am Stator befestigten Bremsbelag (3) ein. Da der mobile Anker (1) mit der Motorwelle (5) verkeilt (8) ist, wird der Bremsseffekt erzielt. Die Standardspannung für diese Art von Bremse beträgt 24V mit Toleranzen von  $\pm 10\%$  der Nennspannung. Die Isolationsklasse dieser Bremse ist "B".

**Luftspalteinstellung**

Der Abstand des Luftspalts S [mm] zwischen dem Stator / Elektromagneten [(3)+(6)] und dem mobilen Anker (1) muß innerhalb der in der Tabelle angegebenen Werte (Snom-Smax) liegen. Die Einstellung wird, sobald der Körper der Bremse am Motor befestigt wurde, an der selbstblockierenden Luftspalteinstellmutter (7) vorgenommen. Mit einer Lehre muß dann geprüft werden, ob der gewünschte Wert für den Luftspalt erreicht wurde. Bei dieser Einstellung muß die Bremse Umgebungstemperatur haben.

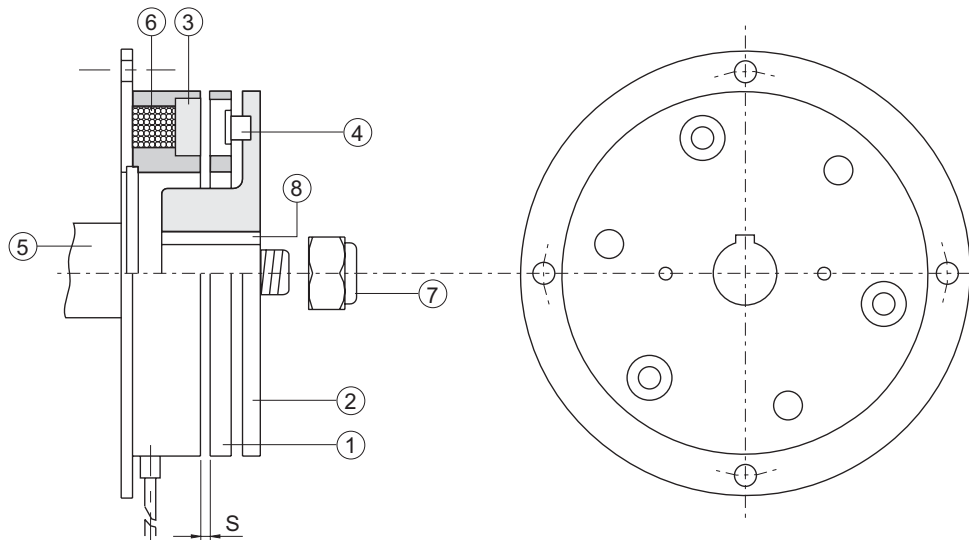
**Ansprechzeit der Bremse**

Bei Gleichstrombremsen, die über eine Diodenbrücke mit Wechselstrom gespeist werden, kann die Ansprechzeit durch den Einsatz von besonderen Netzteilen (Tab. 24) merklich verbessert werden (Ultraschnellbremsung).

**FRENO FP / BRAKE FP / BREMSE FP**

Tab.1.24

Freno / Brake / Bremse	63	71	80	90	100	112	132	160
Snom [mm]	0.2	0.2	0.2	0.2	0.3	0.3	0.3	0.5
Smax [mm]	0.4	0.4	0.4	0.4	0.6	0.6	0.6	1
CF [Nm]	7.5	7.5	15	15	30	30	60	120
Tempo di frenata rapida [ms] Rapid braking time [ms] Schnellbremszeit [ms]	40	100	120	140	200	230	280	340
Tempo di frenata super rapida [ms] Extra-rapid braking time [ms] Ultraschnellbremszeit [ms]	30	45	60	70	85	100	115	140
Tempo di rilascio [ms] Release time [ms] Aufgenommene Leistung [ms]	20	20	16	16	13	13	12	10
Potenza assorbita [W] Absorbed power [W] Aufgenommene Leistung [W]	11.5	11.5	16	16	21	21	28	38
Rumore [dB] Noise level [dB] Geräuschpegel [dB]	35.5	35.5	36	36	38	38	38	44.5



1	Ancora mobile	Mobile armature	Mobiler Anker
2	Flangia di mozzo	Hub flange	Nabenflansch
3	Guarnizione di frizione	Clutch lining	Bremsbelag
4	Molla anulare	Anular spring	Ringfeder
5	Albero	Shaft	Welle
6	Bobina	Coil	Spule
7	Dado regolazione traferro	Air gap setting nut	Luftspalteinstellmutter
8	Chiavetta	Key	Keil
S	Traferro	Air gap	Luftspalt

## 1.7 DATI TECNICI


## 1.7 TECHNICAL SPECIFICATIONS

## 1.7 TECHNISCHE DATEN


TRIFASE  
THREE-PHASE  
DREHSTROM

T

2 P 3000 min<sup>-1</sup>Servoventilazione  
Blower  
Servobelüftung  
230V/50HZ





Tipo Type Typ	Pn		n <sub>n</sub> [min <sup>-1</sup> ]	I <sub>n</sub> (400 V) [A]	η %	cos φ	I <sub>a</sub> I <sub>n</sub>	Ca Cn	C <sub>max</sub> Cn	Cn [Nm]	J <sub>m</sub> [Kgm <sup>2</sup> ]		P <sub>v</sub> [W]	VB [m <sup>3</sup> /min]
	[kW]	[HP]												
T50A*	0.06	0.08	2700	0.25	48	0.64	2.4	2.4	2.6	0.21	0.00008	2.2	—	—
T50B*	0.09	0.12	2700	0.36	52	0.68	2.8	2.5	2.7	0.23	0.00010	2.4	—	—
T56A	0.09	0.12	2740	0.40	58	0.70	3.2	2.7	2.8	0.26	0.00012	2.6	15	0.7
T56B	0.14	0.18	2750	0.50	60	0.72	3.5	2.8	2.9	0.40	0.00015	3.2	15	0.7
T63A	0.18	0.25	2760	0.60	65	0.79	3.7	2.6	2.7	0.60	0.00025	3.7	17	2.6
T63B	0.25	0.35	2790	0.80	69	0.80	3.9	2.9	3.0	0.78	0.00030	4.3	17	2.6
T63C*	0.37	0.50	2790	1.0	72	0.78	4.3	3.0	3.1	1.2	0.00035	5.6	17	2.6
T71A	0.37	0.50	2790	1.1	71	0.81	4.5	2.6	2.7	1.2	0.00038	5.8	17	2.6
T71B	0.55	0.75	2800	1.6	73	0.82	4.5	2.9	3.0	1.8	0.00046	6.2	17	2.6
T71C*	0.75	1.0	2800	1.9	72	0.83	4.6	3.0	3.1	2.1	0.00057	7.4	17	2.6
T80A	0.75	1.0	2820	2.0	76	0.84	4.8	2.3	2.6	2.4	0.00080	8.5	38	5.4
T80B	1.1	1.5	2830	2.6	78	0.86	5.2	2.6	2.7	3.6	0.00097	9.8	38	5.4
T80C*	1.5	2.0	2830	3.0	77	0.86	5.6	2.8	3.0	4.7	0.00120	10.5	38	5.4
T80D*	1.8	2.5	2770	4.2	75	0.85	5.6	2.7	3.0	6.3	0.00130	11.5	38	5.4
T90S	1.5	2.0	2830	3.6	78	0.84	5.5	2.3	2.8	4.9	0.00150	12.0	38	5.4
T90L	2.2	3.0	2840	5.2	79	0.83	6.0	2.8	3.1	7.2	0.00230	13.5	38	5.4
T90LB*	3.0	4.0	2840	6.5	80	0.88	6.1	3.0	3.2	9.3	0.00280	15.5	38	5.4
T100A	3.0	4.0	2860	7.0	81	0.88	6.4	2.4	2.9	9.7	0.00530	18.5	38	5.4
T100B*	4.0	5.5	2860	8.9	84	0.86	6.5	2.1	2.8	13.9	0.00850	21	38	5.4
T112A	4.0	5.5	2860	8.7	84	0.86	6.5	2.1	2.6	13.9	0.00900	27	38	5.4
T112B*	5.5	7.5	2880	11.8	85	0.85	6.8	2.2	2.7	18.0	0.01200	32	38	5.4
T112BL*	7.5	10.0	2860	16.0	86	0.85	6.5	2.9	2.8	25	0.01300	34	38	5.4
T132S	5.5	7.5	2870	13.0	85	0.88	6.0	2.2	2.3	18.0	0.01300	45	38	5.4
T132SL	7.5	10.0	2890	16.5	85	0.88	6.4	2.8	3.2	24	0.02000	48	38	5.4
T132M*	11.0	15.0	2940	21	88	0.87	7.3	2.5	3.5	36	0.02800	54	38	5.4
T132ML*	15.0	20	2900	30	86	0.90	6.8	2.7	3.7	50	0.03000	58	38	5.4
T160MA	11.0	15.0	2900	24	86	0.84	6.4	2.2	2.7	36	0.03200	75	115	27
T160MB	15.0	20	2930	32	88	0.85	7.4	2.2	2.8	49	0.03600	88	115	27
T160L	18.5	25	2910	39	89	0.84	7.6	2.3	2.8	61	0.04000	99	115	27





4 P 1500 min<sup>-1</sup>Servoventilazione  
Blower  
Servobelüftung  
230V/50HZ

Tipo Type Typ	Pn		n <sub>n</sub> [min <sup>-1</sup> ]	I <sub>n</sub> (400 V) [A]	η %	cos φ	I <sub>a</sub> I <sub>n</sub>	Ca Cn	C <sub>max</sub> Cn	Cn [Nm]	J <sub>m</sub> [Kgm <sup>2</sup> ]		P <sub>v</sub> [W]	VB [m <sup>3</sup> /min]
	[kW]	[HP]												
T50A*	0.03	0.05	1350	0.23	50	0.60	2.4	2.0	2.1	0.3	0.00008	2.2	—	—
T50B*	0.06	0.08	1350	0.35	52	0.63	2.6	2.1	2.3	0.4	0.00010	2.4	—	—
T56A	0.06	0.08	1360	0.38	54	0.63	2.5	2.3	2.5	0.4	0.00015	2.5	15.0	0.7
T56B	0.09	0.12	1360	0.45	56	0.65	2.8	2.3	2.5	0.6	0.00015	2.6	15.0	0.7
T56C	0.11	0.15	1360	0.50	58	0.66	2.8	2.4	2.7	0.7	0.00020	3.2	15.0	0.7
T63A	0.13	0.18	1360	0.70	60	0.66	3.0	2.4	2.8	0.8	0.00028	3.7	17.0	2.6
T63B	0.18	0.25	1370	0.75	60	0.68	3.0	2.5	2.8	1.2	0.00040	4.3	17.0	2.6
T63C*	0.22	0.30	1400	0.78	60	0.66	3.2	2.6	2.9	1.5	0.00040	4.3	17.0	2.6
T71A	0.25	0.35	1370	0.86	65	0.70	3.6	2.5	2.7	1.6	0.00050	5.8	17.0	2.6
T71B	0.37	0.50	1380	1.2	67	0.74	3.5	2.5	2.8	2.6	0.00080	6.2	17.0	2.6
T71C*	0.55	0.75	1380	1.5	66	0.72	3.8	2.6	2.8	3.5	0.00090	7.4	17.0	2.6
T80A	0.55	0.75	1390	1.7	68	0.75	4.0	2.5	2.6	3.5	0.00140	8.5	38	5.4
T80B	0.75	1.0	1390	2.0	70	0.76	4.2	2.6	2.8	5.4	0.00170	9.8	38	5.4
T80C*	0.88	1.2	1350	2.6	70	0.75	4.3	2.5	2.7	6.2	0.00200	10.5	38	5.4
T80D*	1.1	1.5	1390	3.1	71	0.75	4.3	2.7	2.8	7.6	0.00230	11.0	38	5.4
T90S	1.1	1.5	1400	3.3	75	0.78	4.2	2.5	2.6	7.6	0.00330	12.0	38	5.4
T90L	1.5	2.0	1400	4.1	78	0.78	4.6	2.6	2.7	9.8	0.00400	13.5	38	5.4
T90LB*	1.8	2.5	1400	5.0	77	0.75	4.7	2.6	2.8	12.2	0.00500	15.5	38	5.4
T100A	2.2	3.0	1410	5.9	78	0.80	4.9	2.5	2.6	14.8	0.00750	19.0	38	5.4
T100B	3.0	4.0	1420	7.3	78	0.82	5.0	2.5	2.7	19.5	0.00850	21	38	5.4
T100BL*	4.0	5.5	1410	9.2	78	0.79	5.0	2.5	2.7	26	0.01100	23	38	5.4
T112A	4.0	5.5	1425	9.0	80	0.81	5.3	2.6	2.9	26	0.01300	29	38	5.4
T112BL*	5.5	7.5	1400	11.7	80	0.82	5.5	2.7	3.0	38	0.01600	35	38	5.4
T132S	5.5	7.5	1440	12.0	81	0.81	5.8	2.5	2.8	37	0.02400	43	38	5.4
T132M	7.5	10.0	1440	16.0	82	0.83	6.2	2.6	3.0	49	0.03300	52	38	5.4
T132ML*	9.2	12.5	1450	20	87	0.83	5.5	2.5	3.2	61	0.03400	54	38	5.4
T160M	11.0	15.0	1455	24	86	0.81	5.3	2.3	2.2	72	0.06200	68	115	27
T160L	15.0	20	1455	32	87	0.82	5.6	2.2	2.3	99	0.07400	78	115	27

TA

TRIFASE  
THREE-PHASE  
DREHSTROM

Tipo Type Typ	FD Autofrenante in D.C. Brake motor In D.C. Gleichstrom-Bremsmotor				FA Autofrenante in A.C. Brake motor In A.C. Wechselstrom-Bremsmotor				FS Autofrenante in D.C. Brake motor in D.C. Gleichstrom-Bremsmotor				FP Autofrenante in D.C. Brake motor in D.C. Gleichstrom-Bremsmotor			
	CF	Z <sub>0</sub>	PB		CF	Z <sub>0</sub>	PB		CF	Z <sub>0</sub>	PB		CF	Z <sub>0</sub>	PB	
	[Nm]	[1/h]	[W]		[Nm]	[1/h]	[W]		[Nm]	[1/h]	[W]		[Nm]	[1/h]	[W]	
—	—	—	—	—	—	—	—	—	—	—	—	—	—	—	—	—
TA56A	1.0	9700	12.0	4.0	—	—	—	—	—	—	—	—	—	—	—	—
TA56B	1.0	8900	12.0	5.0	—	—	—	—	—	—	—	—	—	—	—	—
TA63A	5.0	8100	20	5.0	5.0	8100	18.0	5.0	4.0	8100	17.0	5.0	7.5	8100	11.5	4.1
TA63B	5.0	6750	20	6.0	5.0	6750	18.0	6.0	4.0	6750	17.0	6.0	7.5	6750	11.5	4.7
TA63C	5.0	5400	20	7.0	5.0	5400	18.0	7.0	4.0	5400	17.0	7.0	7.5	5400	11.5	6.0
TA71A	5.0	5400	20	8.0	5.0	5400	18.0	8.0	4.0	5400	17.0	7.0	7.5	5400	11.5	6.2
TA71B	5.0	5400	20	8.0	5.0	5400	18.0	8.0	4.0	5400	17.0	8.0	7.5	5400	11.5	6.6
TA71C	5.0	5500	20	9.0	5.0	5500	18.0	9.0	4.0	5500	17.0	9.0	7.5	5500	11.5	7.8
TA80A	10.0	5400	25	11.0	10.0	5400	25	11.0	8.0	5400	34	11.0	15.0	5400	16.0	9.1
TA80B	10.0	5400	25	12.0	10.0	5400	25	12.0	8.0	5400	34	12.0	15.0	5400	16.0	10.4
TA80C	10.0	5100	25	13.0	10.0	5100	25	13.0	8.0	5100	34	13.0	15.0	5100	16.0	11.1
TA80D	10.0	4900	25	14.0	10.0	4900	25	14.0	8.0	4900	34	14.0	15.0	4900	16.0	12.0
TA90S	16.0	4000	30	17.0	20	4000	30	17.0	8.0	4000	34	14.0	15.0	4000	16.0	12.6
TA90L	16.0	4000	30	18.0	20	4000	30	18.0	8.0	4000	34	15.0	15.0	4000	16.0	14.1
TA90LB	16.0	3800	30	20	20	3800	30	20	8.0	3800	34	18.0	15.0	3800	16.0	16.1
TA100A	32	2500	40	25	40	2500	35	27	11.0	2500	40	22	30	2500	21	19.4
TA100B	32	2400	40	28	40	2400	35	30	11.0	2400	40	25	30	2400	21	22
TA112A	60	1500	50	36	80	1500	35	36	11.0	1500	40	31	30	1500	21	28
TA112B	60	1400	50	41	80	1400	35	41	11.0	1400	40	36	30	1400	21	33
TA112BL	60	1300	50	43	80	1300	35	43	11.0	1300	40	38	30	1300	21	35
TA132S	80	430	55	58	100	430	45	59	17.0	430	40	50	60	430	28	46
TA132SL	80	430	55	61	100	430	45	62	17.0	430	40	58	60	430	28	49
TA132M	80	400	55	67	100	400	45	68	17.0	400	40	59	60	400	28	55
TA132ML	80	400	55	71	100	400	45	72	17.0	400	40	63	60	400	28	59
TA160MA	150	300	85	95	150	300	47	93	25.0	300	45	82	120	300	38	77
TA160MB	150	300	85	108	150	300	47	106	25.0	300	45	95	120	300	38	90
TA160L	150	300	85	119	150	300	47	117	25.0	300	45	106	120	300	38	101


Tipo Type Typ	FD Autofrenante in D.C. Brake motor In D.C. Gleichstrom-Bremsmotor				FA Autofrenante in A.C. Brake motor In A.C. Wechselstrom-Bremsmotor				FS Autofrenante in D.C. Brake motor in D.C. Gleichstrom-Bremsmotor				FP Autofrenante in D.C. Brake motor in D.C. Gleichstrom-Bremsmotor			
	CF	Z <sub>0</sub>	PB		CF	Z <sub>0</sub>	PB		CF	Z <sub>0</sub>	PB		CF	Z <sub>0</sub>	PB	
	[Nm]	[1/h]	[W]		[Nm]	[1/h]	[W]		[Nm]	[1/h]	[W]		[Nm]	[1/h]	[W]	
TA50A	1.0	12500	12.0	3.7	—	—	—	—	—	—	—	—	—	—	—	—
TA50B	1.0	12500	12.0	3.9	—	—	—	—	—	—	—	—	—	—	—	—
TA56A	1.0	12500	12.0	4.0	—	—	—	—	—	—	—	—	—	—	—	—
TA56B	1.0	12500	12.0	5.0	—	—	—	—	—	—	—	—	—	—	—	—
TA56C	1.0	12500	12.0	5.0	—	—	—	—	—	—	—	—	—	—	—	—
TA63A	5.0	10500	20	5.0	5.0	10500	18.0	5.0	4.0	10500	17.0	5.0	7.5	10500	11.5	4.1
TA63B	5.0	10500	20	7.0	5.0	10500	18.0	7.0	4.0	10500	17.0	6.0	7.5	10500	11.5	4.7
TA63C	5.0	10500	20	7.0	5.0	10500	18.0	7.0	4.0	10500	17.0	6.0	7.5	10500	11.5	4.7
TA71A	5.0	18000	20	8.0	5.0	18000	18.0	8.0	4.0	18000	17.0	7.0	7.5	18000	11.5	6.2
TA71B	5.0	17000	20	8.0	5.0	17000	18.0	8.0	4.0	17000	17.0	8.0	7.5	17000	11.5	6.6
TA71C	5.0	16000	20	9.0	5.0	16000	18.0	9.0	4.0	16000	17.0	9.0	7.5	16000	11.5	7.8
TA80A	10.0	9000	25	11.0	10.0	9000	25	11.0	8.0	9000	34	11.0	15.0	9000	16.0	9.1
TA80B	10.0	9000	25	13.0	10.0	9000	25	13.0	8.0	9000	34	12.0	15.0	9000	16.0	10.4
TA80C	10.0	9000	25	13.5	10.0	9000	25	13.5	8.0	9000	34	13.5	15.0	9000	16.0	11.1
TA80D-	10.0	9000	25	14.0	10.0	9000	25	14.0	8.0	9000	34	14.0	15.0	9000	16.0	11.6
TA90S	16.0	13500	30	17.0	20	13500	30	17.0	8.0	13500	34	15.0	15.0	13500	16.0	12.6
TA90L	16.0	11000	30	18.0	20	11000	30	18.0	8.0	11000	34	16.0	15.0	11000	16.0	14.1
TA90LB	16.0	8000	30	20	20	8000	30	20	8.0	8000	34	18.0	15.0	8000	16.0	16.1
TA100A	32	7200	40	26	40	7200	35	28	11.0	7200	40	23	30	7200	21	19.9
TA100B	32	6300	40	28	40	6300	35	30	11.0	6300	40	25	30	6300	21	22
TA100BL	32	6000	40	30	40	6000	35	32	11.0	6000	40	27	30	6000	21	24
TA112A	60	3600	50	38	80	3600	35	38	11.0	3600	40	33	30	3600	21	30
TA112BL	60	3400	50	44	80	3400	35	44	11.0	3400	40	39	30	3400	21	36
TA132S	80	1100	55	56	100	1100	45	57	17.0	1100	40	48	60	1100	28	44
TA132M	80	850	55	66	100	850	45	67	17.0	850	40	57	60	850	28	53
TA132ML	80	800	55	68	100	800	45	69	17.0	800	40	59	60	800	28	55
TA160M	150	750	85	87	150	750	47	85	25	750	45	75	120	750	38	70
TA160L	150	750	85	97	150	750	47	95	25	750	45	83	120	750	38	80

T

TRIFASE  
THREE-PHASE  
DREHSTROM


6 P 1000 min<sup>-1</sup>

Servomotor  
Blower  
Servovelüftung  
230V/50HZ

Tipo Type Typ	Pn		n <sub>n</sub> [min <sup>-1</sup> ]	I <sub>n</sub> (400 V) [A]	η %	cos φ	I <sub>a</sub> I <sub>n</sub>	C <sub>a</sub> C <sub>n</sub>	C <sub>max</sub> C <sub>n</sub>	C <sub>n</sub> [Nm]	J <sub>m</sub> [Kgm <sup>2</sup> ]		P <sub>v</sub> [W]	VB [m <sup>3</sup> /min]
	[kW]	[HP]												
T56B	0.03	0.05	820	0.36	42	0.56	2.4	1.5	1.6	0.6	0.00015	2.6	15.0	0.7
T56C	0.06	0.08	820	0.40	46	0.58	2.4	1.9	2.0	0.7	0.00020	3.0	15.0	0.7
T63B	0.09	0.12	860	0.60	48	0.62	3.0	2.0	2.1	0.9	0.00025	3.8	17.0	2.6
T63C	0.13	0.18	860	0.75	50	0.65	3.2	2.3	2.2	1.2	0.00040	4.2	17.0	2.6
T71A	0.18	0.25	870	1.0	56	0.66	3.0	2.3	2.4	1.9	0.00060	5.7	17.0	2.6
T71B	0.25	0.35	870	1.1	58	0.68	3.1	2.4	2.4	2.6	0.00080	6.4	17.0	2.6
T71C*	0.37	0.50	880	1.2	60	0.68	3.1	2.4	2.5	3.7	0.00100	6.5	17.0	2.6
T80A	0.37	0.50	910	1.6	65	0.70	3.2	2.3	2.5	3.8	0.00200	8.7	38	5.4
T80B	0.55	0.75	910	1.9	68	0.72	3.8	2.3	2.4	5.7	0.00250	10.5	38	5.4
T80C*	0.75	1.0	910	2.3	69	0.72	3.9	2.4	2.4	7.9	0.00260	11.0	38	5.4
T90S	0.75	1.0	920	2.4	72	0.73	3.9	2.4	2.5	7.9	0.00350	12.0	38	5.4
T90L	1.1	1.5	920	3.4	74	0.75	4.2	2.5	2.6	11.5	0.00450	14.0	38	5.4
T90LB*	1.5	2.0	925	4.1	73	0.75	4.4	2.3	2.7	15.5	0.00500	16.0	38	5.4
T100A	1.5	2.0	940	4.2	75	0.76	4.5	2.6	2.8	15.2	0.00900	19.5	38	5.4
T100B	1.9	2.5	940	5.2	77	0.76	4.7	2.6	2.7	19.0	0.01000	21	38	5.4
T100BL	2.2	3.0	940	5.6	78	0.76	4.9	2.4	2.5	22	0.01100	23	38	5.4
T112A	2.2	3.0	950	5.6	80	0.77	4.9	2.4	2.6	22	0.01500	30	38	5.4
T112B	3.0	4.0	940	7.4	80	0.77	5.4	2.0	2.4	31	0.01800	37	38	5.4
T132S	3.0	4.0	950	7.2	81	0.78	5.4	2.1	2.5	30	0.03000	43	38	5.4
T132M	4.0	5.5	950	9.8	83	0.78	5.6	2.2	2.5	40	0.04000	52	38	5.4
T132ML	5.5	7.5	950	13.0	83	0.80	5.7	2.3	2.6	55	0.04200	55	38	5.4
T160M	7.5	10.0	960	15.0	85	0.81	5.2	2.1	2.2	75	0.08800	70	115	27
T160L	11.0	15.0	965	24	85	0.81	5.4	2.2	2.6	109	0.10600	90	115	27


8 P 750 min<sup>-1</sup>

Servomotor  
Blower  
Servovelüftung  
230V/50HZ

Tipo Type Typ	Pn		n <sub>n</sub> [min <sup>-1</sup> ]	I <sub>n</sub> (400 V) [A]	η %	cos φ	I <sub>a</sub> I <sub>n</sub>	C <sub>a</sub> C <sub>n</sub>	C <sub>max</sub> C <sub>n</sub>	C <sub>n</sub> [Nm]	J <sub>m</sub> [Kgm <sup>2</sup> ]		P <sub>v</sub> [W]	VB [m <sup>3</sup> /min]
	[kW]	[HP]												
T56B	0.03	0.05	640	0.40	40	0.50	1.9	1.9	1.9	0.43	0.00010	3.2	15.0	0.7
T63B	0.05	0.07	660	0.56	42	0.52	1.9	2.0	2.0	0.75	0.00030	3.9	17.0	2.6
T63C	0.07	0.10	660	0.63	42	0.52	2.0	2.0	2.1	0.9	0.00060	4.3	17.0	2.6
T71B	0.09	0.12	660	0.65	45	0.56	2.0	2.1	2.2	1.2	0.00080	5.7	17.0	2.6
T71C	0.12	0.17	660	0.80	46	0.58	2.1	2.2	2.2	1.5	0.00100	6.4	17.0	2.6
T80A	0.18	0.25	670	0.90	55	0.60	2.4	2.2	2.4	3.0	0.00200	8.8	38	5.4
T80B	0.25	0.35	670	1.2	57	0.61	2.6	2.3	2.5	3.4	0.00250	10.5	38	5.4
T80C	0.37	0.50	670	1.6	60	0.60	3.0	2.0	2.6	5.2	0.00280	11.0	38	5.4
T90S	0.37	0.50	680	1.5	61	0.62	3.3	2.1	2.4	4.9	0.00350	12.0	38	5.4
T90L	0.55	0.75	680	2.2	63	0.63	3.4	2.0	2.1	7.5	0.00450	14.0	38	5.4
T90LB	0.75	1.0	680	2.8	65	0.62	3.6	2.1	2.0	10.0	0.00550	16.0	38	5.4
T100A	0.75	1.0	690	2.7	69	0.67	3.8	1.9	2.1	9.9	0.00900	19.8	38	5.4
T100B	1.1	1.5	690	4.0	71	0.68	4.0	2.1	2.3	15.0	0.01000	22	38	5.4
T100BL	1.3	1.8	680	4.6	71	0.68	4.2	2.0	2.3	21	0.01200	24	38	5.4
T112A	1.5	2.0	700	4.7	73	0.70	4.0	2.1	2.4	20	0.01500	32	38	5.4
T132S	2.2	3.0	700	7.5	73	0.72	4.6	2.0	2.4	30	0.03000	44	38	5.4
T132M	3.0	4.0	700	8.5	76	0.74	4.6	1.9	2.2	40	0.04000	53	38	5.4
T132ML	4.0	5.5	680	11.0	74	0.76	4.9	1.8	2.1	56	0.05000	58	38	5.4
T160MA	4.0	5.5	720	11.5	80	0.76	4.6	1.9	2.3	53	0.08000	64	115	27
T160MB	5.5	7.5	725	13.5	81	0.77	4.7	2.0	2.2	72	0.09200	72	115	27
T160L	7.5	10.0	725	18.5	82	0.78	4.6	2.0	2.1	99	0.11200	86	115	27

12 P 500 min<sup>-1</sup>

Servomotor  
Blower  
Servovelüftung  
230V/50HZ

Tipo Type Typ	Pn		n <sub>n</sub> [min <sup>-1</sup> ]	I <sub>n</sub> (400 V) [A]	η %	cos φ	I <sub>a</sub> I <sub>n</sub>	C <sub>a</sub> C <sub>n</sub>	C <sub>max</sub> C <sub>n</sub>	C <sub>n</sub> [Nm]	J <sub>m</sub> [Kgm <sup>2</sup> ]		P <sub>v</sub> [W]	VB [m <sup>3</sup> /min]
	[kW]	[HP]												
T71C	0.09	0.12	410	0.60	36	0.60	1.7	1.4	1.6	2.1	0.00120	6.5	17.0	2.6
T80C	0.18	0.25	415	1.1	42	0.61	1.8	1.5	1.7	4.0	0.00300	11.0	38	5.4
T90L	0.25	0.35	420	1.7	43	0.60	1.9	1.6	1.8	5.6	0.00500	15.0	38	5.4
T100A	0.37	0.50	425	2.1	46	0.60	1.7	1.8	1.9	8.3	0.01000	21	38	5.4
T100B	0.55	0.75	450	2.8	54	0.62	2.0	2.4	2.0	11.5	0.01300	23	38	5.4
T112B	0.75	1.0	450	3.0	60	0.63	2.1	2.6	2.1	16.0	0.01600	28	38	5.4
T132S	1.1	1.5	455	6.1	61	0.63	3.3	2.0	1.8	23	0.03000	55	38	5.4
T132M	1.5	2.0	460	6.5	62	0.60	3.4	1.8	1.7	31	0.03800	66	38	5.4
T160M	3.0	4.0	460	11.0	70	0.64	3.8	1.9	1.8	63	0.09000	80	115	27
T160L	4.0	5.5	450	14.0	72	0.66	4.0	2.2	2.0	83	0.13000	90	115	27

TRIFASE  
THREE-PHASE  
DREHSTROM


TA

Tipo Type Typ	FD Autofrenante in D.C. Brake motor In D.C. Gleichstrom-Bremsmotor				FA Autofrenante in A.C. Brake motor In A.C. Wechselstrom-Bremsmotor				FS Autofrenante in D.C. Brake motor in D.C. Gleichstrom-Bremsmotor				FP Autofrenante in D.C. Brake motor in D.C. Gleichstrom-Bremsmotor			
	CF	Z <sub>0</sub>	PB		CF	Z <sub>0</sub>	PB		CF	Z <sub>0</sub>	PB		CF	Z <sub>0</sub>	PB	
	[Nm]	[1/h]	[W]		[Nm]	[1/h]	[W]		[Nm]	[1/h]	[W]		[Nm]	[1/h]	[W]	
TA56B	1.0	21500	12.0	4.0	—	—	—	—	—	—	—	—	—	—	—	—
TA56C	1.0	21500	12.0	5.0	—	—	—	—	—	—	—	—	—	—	—	—
TA63B	5.0	18000	20	5.0	5.0	18000	18.0	5.0	4.0	18000	17.0	5.0	7.5	18000	11.5	4.2
TA63C	5.0	18000	20	6.0	5.0	18000	18.0	6.0	4.0	18000	17.0	6.0	7.5	18000	11.5	4.6
TA71A	5.0	25000	20	7.0	5.0	25000	18.0	7.0	4.0	25000	17.0	7.0	7.5	25000	11.5	6.1
TA71B	5.0	25000	20	8.0	5.0	25000	18.0	8.0	4.0	25000	17.0	8.0	7.5	25000	11.5	6.8
TA71C	5.0	24000	20	8.0	5.0	24000	18.0	8.0	4.0	24000	17.0	8.0	7.5	24000	11.5	6.9
TA80A	10.0	16000	25	11.0	10.0	16000	25	11.0	8.0	16000	34	11.0	15.0	16000	16.0	9.3
TA80B	10.0	16000	25	13.0	10.0	16000	25	13.0	8.0	16000	34	13.0	15.0	16000	16.0	11.1
TA80C	10.0	15000	25	14.0	10.0	15000	25	14.0	8.0	15000	34	14.0	15.0	15000	16.0	11.6
TA90S	16.0	15000	30	17.0	20	15000	30	17.0	8.0	15000	34	15.0	15.0	15000	16.0	12.6
TA90L	16.0	13500	30	18.0	20	13500	30	18.0	8.0	13500	34	17.0	15.0	13500	16.0	14.6
TA90LB	16.0	13000	30	19.5	20	13000	30	19.5	8.0	13000	34	18.5	15.0	13000	16.0	16.6
TA100A	32	10000	40	26	40	10000	35	28	11.0	10000	40	23	30	10000	21	20
TA100B	32	7500	40	28	40	7500	35	30	11.0	7500	40	25	30	7500	21	22
TA100BL	32	7000	40	30	40	7000	35	32	11.0	7000	40	27	30	7000	21	24
TA112A	60	6000	50	39	80	6000	35	39	11.0	6000	40	34	30	6000	21	31
TA112B	60	5500	50	46	80	5500	35	46	11.0	5500	40	41	30	5500	21	38
TA132S	80	1600	55	56	100	1600	45	57	17.0	1600	40	48	60	1600	28	44
TA132M	80	1350	55	65	100	1350	45	66	17.0	1350	40	57	60	1350	28	53
TA132ML	80	1100	55	68	100	1100	45	69	17.0	1100	40	60	60	1100	28	56
TA160M	150	1000	85	89	150	1000	47	87	25	1000	45	75	120	1000	38	72
TA160L	150	850	85	109	150	850	47	107	25	850	45	95	120	850	38	92


Tipo Type Typ	FD Autofrenante in D.C. Brake motor In D.C. Gleichstrom-Bremsmotor				FA Autofrenante in A.C. Brake motor In A.C. Wechselstrom-Bremsmotor				FS Autofrenante in D.C. Brake motor in D.C. Gleichstrom-Bremsmotor				FP Autofrenante in D.C. Brake motor in D.C. Gleichstrom-Bremsmotor			
	CF	Z <sub>0</sub>	PB		CF	Z <sub>0</sub>	PB		CF	Z <sub>0</sub>	PB		CF	Z <sub>0</sub>	PB	
	[Nm]	[1/h]	[W]		[Nm]	[1/h]	[W]		[Nm]	[1/h]	[W]		[Nm]	[1/h]	[W]	
TA56B	1.0	27000	12.0	5.0	—	—	—	—	—	—	—	—	—	—	—	—
TA63B	5.0	22500	20	6.0	5.0	22500	18.0	6.0	4.0	22500	17.0	5.0	7.5	22500	11.5	4.3
TA63C	5.0	22500	20	6.0	5.0	22500	18.0	6.0	4.0	22500	17.0	6.0	7.5	22500	11.5	4.7
TA71B	5.0	27000	20	7.0	5.0	27000	18.0	7.0	4.0	27000	17.0	7.0	7.5	27000	11.5	6.1
TA71C	5.0	27000	20	8.0	5.0	27000	18.0	8.0	4.0	27000	17.0	8.0	7.5	27000	11.5	6.8
TA80A	10.0	27000	25	11.0	10.0	27000	25	11.0	8.0	27000	34	10.0	15.0	27000	16.0	9.4
TA80B	10.0	27000	25	13.0	10.0	27000	25	13.0	8.0	27000	34	13.0	15.0	27000	16.0	11.1
TA80C	10.0	25500	25	14.0	10.0	25500	25	14.0	8.0	25500	34	14.0	15.0	25500	16.0	11.6
TA90S	16.0	18000	30	17.0	20	18000	30	17.0	8.0	18000	34	15.0	15.0	18000	16.0	12.6
TA90L	16.0	15000	30	18.0	20	15000	30	18.0	8.0	15000	34	17.0	15.0	15000	16.0	14.6
TA90LB	16.0	14500	30	20	20	14500	30	20	8.0	14500	34	19.0	15.0	14500	16.0	16.6
TA100A	32	12500	40	26	40	12500	35	28	11.0	12500	40	24	30	12500	21	21
TA100B	32	8500	40	29	40	8500	35	31	11.0	8500	40	26	30	8500	21	23
TA100BL	32	8000	40	31	40	8000	35	33	11.0	8000	40	28	30	8000	21	25
TA112A	60	6500	50	41	80	6500	35	41	11.0	6500	40	36	30	6500	21	33
TA132S	80	1900	55	57	100	1900	45	58	17.0	1900	40	49	60	1900	28	45
TA132M	80	1900	55	66	100	1900	45	67	17.0	1900	40	58	60	1900	28	54
TA132ML	80	1900	55	71	100	1900	45	72	17.0	1900	40	63	60	1900	28	59
TA160MA	150	1600	85	83	150	1600	47	81	25	1600	45	69	120	1600	38	66
TA160MB	150	1600	85	91	150	1600	47	89	25	1600	45	77	120	1600	38	74
TA160L	150	1600	85	105	150	1600	47	103	25	1600	45	91	120	1600	38	88

Tipo Type Typ	FD Autofrenante in D.C. Brake motor In D.C. Gleichstrom-Bremsmotor				FA Autofrenante in A.C. Brake motor In A.C. Wechselstrom-Bremsmotor				FS Autofrenante in D.C. Brake motor in D.C. Gleichstrom-Bremsmotor				FP Autofrenante in D.C. Brake motor in D.C. Gleichstrom-Bremsmotor			
	CF	Z <sub>0</sub>	PB		CF	Z <sub>0</sub>	PB		CF	Z <sub>0</sub>	PB		CF	Z <sub>0</sub>	PB	
	[Nm]	[1/h]	[W]		[Nm]	[1/h]	[W]		[Nm]	[1/h]	[W]		[Nm]	[1/h]	[W]	
TA71C	5.0	21500	20	8.0	5.0	21500	18.0	8.0	4.0	21500	17.0	8.0	7.5	21500	11.5	6.9
TA80B	10.0	21500	25	14.0	10.0	21500	25	14.0	8.0	21500	34	14.0	15.0	21500	16.0	11.6
TA90L	16.0	27000	30	19.0	20	27000	30	19.0	8.0	27000	34	18.0	15.0	27000	16.0	15.6
TA100A	32	13500	40	25	40	13500	35	29	11.0	13500	40	25	30	13500	21	22
TA100B	32	11500	40	27	40	11500	35	32	11.0	11500	40	27	30	11500	21	24
TA112B	60	11000	50	35	80	11000	35	37	11.0	11000	40	33	30	11000	21	29
TA132S	80	2000	55	66	100	2000	45	69	17.0	2000	40	64	60	2000	28	56
TA132M	80	2000	55	79	100	2000	45	83	25	2000	45	75	60	2000	28	67
TA160M	150	1650	85	99	150	1650	47	97	25	1650	45	94	120	1650	38	82
TA160L	150	1650	85	109	150	1650	47	107	25	1650	45	99	120	1650	38	92





2 P 3000 min<sup>-1</sup>





Tipo Type Typ	Pn [kW] (400V)		n <sub>n</sub> [min <sup>-1</sup> ]		I <sub>n</sub> [A] (400V)		η %		cos φ		I <sub>a</sub> I <sub>n</sub>		Ca Cn		C <sub>max</sub> Cn		Cn [Nm]		J <sub>m</sub> <sup>2</sup> [Kgm <sup>2</sup> ]	
	50Hz	60Hz	50Hz	60Hz	50Hz	60Hz	50Hz	60Hz	50Hz	60Hz	50Hz	60Hz	50Hz	60Hz	50Hz	60Hz	50Hz	60Hz		
H56A	0.09	0.09	2740	3288	0.33	0.30	61	63	0.65	0.69	3.2	3.5	2.7	3.1	3.0	3.3	0.31	0.26	0.00012	2.6
H56B	0.12	0.12	2750	3300	0.40	0.36	63	65	0.69	0.73	3.5	3.9	2.8	3.2	3.1	3.4	0.42	0.35	0.00015	3.2
H63B	0.18	0.18	2790	3348	0.60	0.55	68	70	0.64	0.68	3.7	4.1	2.6	3.0	2.9	3.1	0.62	0.51	0.00030	4.3
H63C	0.25	0.25	2790	3348	0.80	0.73	72	75	0.62	0.67	3.9	4.3	2.9	3.3	3.2	3.5	0.86	0.71	0.00035	5.6
H71B	0.37	0.37	2800	3360	1.0	0.91	75	77	0.72	0.77	4.5	5.0	2.6	3.0	2.9	3.1	1.3	1.1	0.00046	6.2
H71C	0.55	0.55	2800	3360	1.6	1.5	77	79	0.65	0.69	4.5	5.0	2.9	3.3	3.2	3.5	1.9	1.6	0.00057	7.4
H80B	0.75	0.75	2830	3396	1.9	1.7	80	82	0.71	0.76	4.8	5.3	3.0	3.5	3.3	3.6	2.5	2.1	0.00097	9.8
H80C	1.1	1.1	2830	3396	2.6	2.4	83	83	0.75	0.81	5.2	5.7	2.6	3.0	2.9	3.1	3.7	3.1	0.00120	10.5
H90S	1.5	1.5	2830	3396	3.5	3.2	84	84	0.76	0.81	5.6	6.2	2.8	3.2	3.1	3.4	5.1	4.2	0.00230	13.5
H90LB	2.2	2.2	2840	3408	5.2	4.7	86	86	0.73	0.78	6.0	6.6	2.8	3.2	3.1	3.4	7.4	6.2	0.00280	15.5
H100B	3.0	3.0	2860	3432	7.0	6.4	87	88	0.73	0.78	6.4	7.0	2.4	2.8	2.6	2.9	10.0	8.4	0.00850	21
H112B	4.0	4.0	2880	3456	8.7	7.9	88	89	0.77	0.83	6.5	7.2	2.1	2.4	2.3	2.5	13.3	11.1	0.01200	32
H132SL	5.5	5.5	2890	3468	13.0	11.8	89	92	0.69	0.73	6.0	6.6	2.2	2.5	2.4	2.7	18.2	15.2	0.02000	48
H132M	7.5	7.5	2940	3528	16.5	15.0	90	92	0.74	0.79	6.4	7.0	2.8	3.2	3.1	3.4	24	20	0.02800	54
H160MA	11.0	11.0	2900	3480	24	22	91	93	0.73	0.78	6.4	7.0	2.2	2.5	2.4	2.7	36	30	0.03200	75
H160MB	15.0	15.0	2930	3516	32	29	92	93	0.75	0.80	7.4	8.1	2.2	2.5	2.4	2.7	49	41	0.03600	88
H160L	18.5	18.5	2910	3492	39	35	92	94	0.75	0.80	7.6	8.4	2.3	2.6	2.5	2.8	61	51	0.04000	99

4 P 1500 min<sup>-1</sup>


Tipo Type Typ	Pn [kW] (400V)		n <sub>n</sub> [min <sup>-1</sup> ]		I <sub>n</sub> [A] (400V)		η %		cos φ		I <sub>a</sub> I <sub>n</sub>		Ca Cn		C <sub>max</sub> Cn		Cn [Nm]		J <sub>m</sub> <sup>2</sup> [Kgm <sup>2</sup> ]	
	50Hz	60Hz	50Hz	60Hz	50Hz	60Hz	50Hz	60Hz	50Hz	60Hz	50Hz	60Hz	50Hz	60Hz	50Hz	60Hz	50Hz	60Hz		
H56A	0.06	0.06	1360	1632	0.38	0.35	57	58	0.65	0.43	2.5	2.8	2.3	2.6	2.5	2.8	0.42	0.35	0.00020	3.2
H56B	0.09	0.09	1360	1632	0.45	0.41	59	61	0.69	0.52	2.8	3.1	2.3	2.6	2.5	2.8	0.63	0.53	0.00020	3.2
H63A	0.12	0.12	1360	1632	0.70	0.64	63	65	0.64	0.42	3.0	3.3	2.4	2.8	2.6	2.9	0.84	0.70	0.00040	4.3
H63B	0.18	0.18	1370	1644	0.75	0.68	63	65	0.62	0.59	3.0	3.3	2.5	2.9	2.8	3.0	1.3	1.1	0.00040	4.3
H71A	0.25	0.25	1370	1644	0.9	0.78	68	70	0.72	0.66	3.6	4.0	2.5	2.9	2.8	3.0	1.7	1.5	0.00090	7.4
H71B	0.37	0.37	1380	1656	1.2	1.1	70	72	0.65	0.68	3.5	3.9	2.5	2.9	2.8	3.0	2.6	2.1	0.00090	7.4
H80A	0.55	0.55	1390	1668	1.7	1.6	71	74	0.71	0.70	4.0	4.4	2.5	2.9	2.8	3.0	3.8	3.2	0.00230	11.0
H80B	0.75	0.75	1390	1668	2.0	1.8	81	83	0.75	0.71	4.2	4.6	2.6	3.0	2.9	3.1	5.2	4.3	0.00230	11.0
H90S	1.1	1.1	1400	1680	3.3	3.0	84	84	0.76	0.63	4.2	4.6	2.5	2.9	2.8	3.0	7.5	6.3	0.00400	13.5
H90L	1.5	1.5	1400	1680	4.1	3.7	85	84	0.73	0.69	4.6	5.1	2.6	3.0	2.9	3.1	10.2	8.5	0.00500	15.5
H100A	2.2	2.2	1410	1692	5.9	5.4	86	88	0.73	0.68	4.9	5.4	2.5	2.9	2.8	3.0	14.9	12.4	0.01100	23
H100B	3.0	3.0	1420	1704	7.8	7.1	87	84	0.77	0.72	5.0	5.5	2.5	2.9	2.8	3.0	20	16.8	0.01100	23
H112A	4.0	4.0	1425	1710	9.2	8.4	88	88	0.69	0.79	5.3	5.8	2.6	3.0	2.9	3.1	27	22	0.01600	35
H132S	5.5	5.5	1440	1728	12.0	10.9	89	90	0.74	0.81	5.8	6.4	2.5	2.9	2.8	3.0	36	30	0.02400	52
H132M	7.5	7.5	1440	1728	16.0	14.6	90	90	0.73	0.83	6.2	6.8	2.6	3.0	2.9	3.1	50	41	0.03400	54
H160M	11.0	11.0	1455	1746	24	22	91	93	0.75	0.78	5.3	5.8	2.3	2.6	2.5	2.8	72	60	0.06200	68
H160L	15.0	15.0	1455	1746	32	29	92	94	0.75	0.79	5.6	6.2	2.2	2.5	2.4	2.7	99	82	0.07400	78




Tipo Type Typ	FD Autofrenante in D.C. Brake motor In D.C. Gleichstrom-Bremsmotor				FA Autofrenante in A.C. Brake motor In A.C. Wechselstrom-Bremsmotor				FS Autofrenante in D.C. Brake motor in D.C. Gleichstrom-Bremsmotor				FP Autofrenante in D.C. Brake motor in D.C. Gleichstrom-Bremsmotor			
	CF	Z <sub>0</sub>	PB		CF	Z <sub>0</sub>	PB		CF	Z <sub>0</sub>	PB		CF	Z <sub>0</sub>	PB	
	[Nm]	[1/h]	[W]		[Nm]	[1/h]	[W]		[Nm]	[1/h]	[W]		[Nm]	[1/h]	[W]	
HA56A	1.0	9700	12.0	4.0	—	—	—	—	—	—	—	—	—	—	—	—
HA56B	1.0	8900	12.0	5.0	—	—	—	—	—	—	—	—	—	—	—	—
HA63B	5.0	6750	20	6.0	5.0	6750	18.0	6.0	4.0	6750	17.0	6.0	7.5	6750	11.5	4.7
HA63C	5.0	5400	20	7.0	5.0	5400	18.0	7.0	4.0	5400	17.0	7.0	7.5	5400	11.5	6.0
HA71B	5.0	5400	20	8.0	5.0	5400	18.0	8.0	4.0	5400	17.0	8.0	7.5	5400	11.5	6.6
HA71C	5.0	5500	20	9.0	5.0	5500	18.0	9.0	4.0	5500	17.0	9.0	7.5	5500	11.5	7.8
HA80B	10.0	5400	25	12.0	10.0	5400	25	12.0	8.0	5400	34	12.0	15.0	5400	16.0	10.4
HA80C	10.0	5100	25	13.0	10.0	5100	25	13.0	8.0	5100	34	13.0	15.0	5100	16.0	11.1
HA90S	16.0	4000	30	18.0	20	4000	30	18.0	8.0	4000	34	15.0	15.0	4000	16.0	14.1
HA90LB	16.0	3800	30	20	20	3800	30	20	8.0	3800	34	18.0	15.0	3800	16.0	16.1
HA100B	32	2400	40	28	40	2400	35	30	11.0	2400	40	25	30	2400	21	22
HA112B	60	1400	50	41	80	1400	35	41	11.0	1400	40	36	30	1400	21	33
HA132SL	80	430	55	61	100	430	45	62	17.0	430	40	58	60	430	28	49
HA132M	80	400	55	67	100	400	45	68	17.0	400	40	59	60	400	28	55
HA160MA	150	300	85	95	150	300	47	93	25.0	300	45	82	120	300	38	77
HA160MB	150	300	85	108	150	300	47	106	25.0	300	45	95	120	300	38	90
HA160L	150	300	85	119	150	300	47	117	25.0	300	45	106	120	300	38	101

Tipo Type Typ	FD Autofrenante in D.C. Brake motor In D.C. Gleichstrom-Bremsmotor				FA Autofrenante in A.C. Brake motor In A.C. Wechselstrom-Bremsmotor				FS Autofrenante in D.C. Brake motor in D.C. Gleichstrom-Bremsmotor				FP Autofrenante in D.C. Brake motor in D.C. Gleichstrom-Bremsmotor			
	CF	Z <sub>0</sub>	PB		CF	Z <sub>0</sub>	PB		CF	Z <sub>0</sub>	PB		CF	Z <sub>0</sub>	PB	
	[Nm]	[1/h]	[W]		[Nm]	[1/h]	[W]		[Nm]	[1/h]	[W]		[Nm]	[1/h]	[W]	
HA56A	1.0	12500	12.0	5.0	—	—	—	—	—	—	—	—	—	—	—	—
HA56B	1.0	12500	12.0	5.0	—	—	—	—	—	—	—	—	—	—	—	—
HA63A	5.0	10500	20	7.0	5.0	10500	18.0	7.0	4.0	10500	17.0	6.0	7.5	10500	11.5	4.7
HA63B	5.0	10500	20	7.0	5.0	10500	18.0	7.0	4.0	10500	17.0	6.0	7.5	10500	11.5	4.7
HA71A	5.0	16000	20	9.0	5.0	16000	18.0	9.0	4.0	16000	17.0	9.0	7.5	16000	11.5	7.8
HA71B	5.0	16000	20	9.0	5.0	16000	18.0	9.0	4.0	16000	17.0	9.0	7.5	16000	11.5	7.8
HA80A	10.0	9000	25	14.0	10.0	9000	25	14.0	8.0	9000	34	14.0	15.0	9000	16.0	11.6
HA80B	10.0	9000	25	14.0	10.0	9000	25	14.0	8.0	9000	34	14.0	15.0	9000	16.0	11.6
HA90S	16.0	11000	30	18.0	20	11000	30	18.0	8.0	11000	34	16.0	15.0	11000	16.0	14.1
HA90L	16.0	8000	30	20	20	8000	30	20	8.0	8000	34	18.0	15.0	8000	16.0	16.1
HA100A	32	6000	40	30	40	6000	35	32	11.0	6000	40	27	30	6000	21	24
HA100B	32	6000	40	30	40	6000	35	32	11.0	6000	40	27	30	6000	21	24
HA112A	60	3400	50	44	80	3400	35	44	11.0	3400	40	39	30	3400	21	36
HA132S	80	1100	55	56	100	1100	45	57	17.0	1100	40	48	60	1100	28	44
HA132M	80	800	55	68	100	800	45	69	17.0	800	40	59	60	800	28	55
HA160M	150	750	85	87	150	750	47	85	25.0	750	45	75	120	750	38	70
HA160L	150	750	85	97	150	750	47	95	25.0	750	45	83	120	750	38	80


2 P 3000 min<sup>-1</sup>

Tipo Type Typ	n <sub>B</sub> [min <sup>-1</sup> ]	n <sub>max</sub> [min <sup>-1</sup> ]	n <sub>L</sub> [min <sup>-1</sup> ]	P <sub>n</sub>		P <sub>max</sub>		P <sub>L</sub>		C <sub>B</sub> [Nm]	C <sub>max</sub> [Nm]	C <sub>L</sub> [Nm]	I <sub>n</sub> (400 V) (50Hz) [A]	f <sub>B</sub> [Hz]	f <sub>max</sub> [Hz]	f <sub>L</sub> [Hz]	J <sub>m</sub> [Kgm <sup>2</sup> ]	
				[kW]	[HP]	[kW]	[HP]	[kW]	[HP]									
I50A	3000	4800	6000	0.06	0.08	0.06	0.08	0.03	0.04	0.19	0.12	0.05	0.30	50	80	100	0.00010	2.4
I56A	3000	4800	6000	0.09	0.12	0.09	0.12	0.05	0.07	0.29	0.18	0.07	0.40	50	80	100	0.00015	3.2
I63A	3000	4800	6000	0.18	0.24	0.18	0.24	0.09	0.12	0.57	0.36	0.14	0.60	50	80	100	0.00025	3.7
I63B	3000	4800	6000	0.25	0.34	0.25	0.34	0.13	0.18	0.80	0.50	0.20	0.80	50	80	100	0.00030	4.3
I63C	3000	4800	6000	0.37	0.50	0.37	0.50	0.19	0.26	1.2	0.74	0.29	1.0	50	80	100	0.00035	5.6
I71B	3000	6000	7200	0.55	0.75	0.55	0.75	0.28	0.38	1.8	0.88	0.36	1.6	50	100	120	0.00046	6.2
I71C	3000	6000	7200	0.75	1.0	0.75	1.0	0.38	0.52	2.4	1.2	0.50	1.9	50	100	120	0.00057	7.4
I80B	3000	6000	7200	1.1	1.5	1.1	1.5	0.55	0.75	3.5	1.8	0.73	2.6	50	100	120	0.00097	9.8
I80C	3000	6000	7200	1.5	2.0	1.5	2.0	0.75	1.0	4.8	2.4	1.0	3.0	50	100	120	0.00120	10.5
I80D	3000	6000	7200	1.9	2.5	1.9	2.5	0.93	1.3	5.9	3.0	1.2	4.2	50	100	120	0.00130	11.5
I90L	3000	6000	7200	2.2	3.0	2.2	3.0	1.1	1.5	7.0	3.5	1.5	5.2	50	100	120	0.00230	13.5
I100A	3000	6000	7200	3.0	4.1	3.0	4.1	1.5	2.0	9.6	4.8	2.0	7.0	50	100	120	0.00530	18.5
I100B	3000	6000	7200	4.0	5.4	4.0	5.4	2.0	2.7	12.7	6.4	2.7	8.5	50	100	120	0.00850	21
I112B	3000	6000	7200	5.5	7.5	5.5	7.5	2.8	3.7	17.5	8.8	3.7	11.8	50	100	120	0.01200	32
I112BL	3000	6000	7200	7.5	10	7.5	10.2	3.8	5.1	24	11.9	5.0	15.0	50	100	120	0.01300	34
I132M	3000	6000	7200	11.0	15	11.0	15.0	5.5	7.5	35	17.5	7.3	21	50	100	120	0.02800	54
I132ML	3000	6000	7200	15.0	20	15.0	20	7.5	10.2	48	24	10.0	30	50	100	120	0.03000	58
I160L	3000	6000	7200	18.5	25	18.5	25	9.3	12.6	59	29	12.3	39	50	100	120	0.04000	99

4 P 3000 min<sup>-1</sup>

Tipo Type Typ	n <sub>B</sub> [min <sup>-1</sup> ]	n <sub>max</sub> [min <sup>-1</sup> ]	n <sub>L</sub> [min <sup>-1</sup> ]	P <sub>n</sub>		P <sub>max</sub>		P <sub>L</sub>		C <sub>B</sub> [Nm]	C <sub>max</sub> [Nm]	C <sub>L</sub> [Nm]	I <sub>n</sub> (400 V) (50Hz) [A]	f <sub>B</sub> [Hz]	f <sub>max</sub> [Hz]	f <sub>L</sub> [Hz]	J <sub>m</sub> [Kgm <sup>2</sup> ]	
				[kW]	[HP]	[kW]	[HP]	[kW]	[HP]									
I50A	1500	2400	3000	0.03	0.04	0.03	0.04	0.02	0.03	0.19	0.12	0.05	0.20	50	80	100	0.00010	2.4
I56A	1500	2400	3000	0.06	0.08	0.06	0.08	0.03	0.04	0.38	0.24	0.10	0.40	50	80	100	0.00015	2.5
I56C	1500	2400	3000	0.11	0.15	0.11	0.15	0.05	0.07	0.70	0.44	0.16	0.50	50	80	100	0.00020	3.2
I63A	1500	2400	3000	0.13	0.18	0.13	0.18	0.06	0.08	0.83	0.52	0.19	0.70	50	80	100	0.00028	3.7
I63B	1500	2400	3000	0.18	0.24	0.18	0.24	0.06	0.08	1.2	0.72	0.19	0.80	50	80	100	0.00040	4.3
I71A	1500	2700	3300	0.25	0.34	0.25	0.34	0.12	0.16	1.6	0.88	0.35	0.90	50	90	110	0.00050	5.8
I71B	1500	2700	3300	0.37	0.50	0.37	0.50	0.18	0.24	2.4	1.3	0.52	1.2	50	90	110	0.00090	7.4
I80A	1500	2700	3300	0.55	0.75	0.55	0.75	0.27	0.37	3.5	2.0	0.78	1.6	50	90	110	0.00140	8.5
I80B	1500	2700	3300	0.75	1.0	0.75	1.0	0.38	0.52	4.8	2.7	1.1	2.0	50	90	110	0.00170	9.8
I80C	1500	2700	3300	0.90	1.2	0.90	1.2	0.44	0.60	5.6	3.1	1.3	2.6	50	90	110	0.00230	11.0
I90S	1500	2700	3300	1.1	1.5	1.1	1.5	0.55	0.75	7.0	3.9	1.6	3.3	50	90	110	0.00330	12.0
I90L	1500	2700	3300	1.5	2.0	1.5	2.0	0.75	1.0	9.6	5.3	2.2	4.1	50	90	110	0.00400	13.5
I90LB	1500	2700	3300	1.8	2.5	1.8	2.5	0.9	1.2	11.5	6.4	2.6	5.0	50	90	110	0.00500	15.5
I100A	1500	2700	3300	2.2	3.0	2.2	3.0	1.1	1.5	14.0	7.8	3.2	5.9	50	90	110	0.00750	19.0
I100B	1500	2700	3300	3.0	4.1	3.0	4.1	1.5	2.0	19.1	10.6	4.3	7.8	50	90	110	0.01100	23
I112A	1500	2700	3300	4.0	5.4	4.0	5.4	2.0	2.7	25	14.2	5.8	9.2	50	90	110	0.01300	29
I132S	1500	2700	3300	5.5	7.5	5.5	7.5	2.3	3.1	35	19.5	6.7	12.0	50	90	110	0.02400	43
I132M	1500	2700	3300	7.5	10.2	7.5	10.2	3.8	5.2	48	27	11.0	16.0	50	90	110	0.03300	52
I132ML	1500	2700	3300	9.2	12.5	9.2	12.5	4.6	6.3	59	33	13.3	20	50	90	110	0.03400	54
I160M	1500	2700	3300	11.0	15.0	11.0	15.0	5.5	7.5	70	39	15.9	24	50	90	110	0.06200	68
I160L	1500	2700	3300	15.0	20	15.0	20	7.5	10.2	96	53	22	32	50	90	110	0.07400	78

6 P 1000 min<sup>-1</sup>

Tipo Type Typ	n <sub>B</sub> [min <sup>-1</sup> ]	n <sub>max</sub> [min <sup>-1</sup> ]	n <sub>L</sub> [min <sup>-1</sup> ]	P <sub>n</sub>		P <sub>max</sub>		P <sub>L</sub>		C <sub>B</sub> [Nm]	C <sub>max</sub> [Nm]	C <sub>L</sub> [Nm]	I <sub>n</sub> (400 V) (50Hz) [A]	f <sub>B</sub> [Hz]	f <sub>max</sub> [Hz]	f <sub>L</sub> [Hz]	J <sub>m</sub> [Kgm <sup>2</sup> ]	
				[kW]	[HP]	[kW]	[HP]	[kW]	[HP]									
I56A	1000	1400	1800	0.03	0.04	0.03	0.04	0.02	0.03	0.29	0.20	0.08	0.4	50	70	90	0.00020	3.0
I63B	1000	1400	1800	0.09	0.12	0.09	0.12	0.05	0.07	0.86	0.61	0.24	0.6	50	70	90	0.00040	4.2
I71A	1000	1600	2000	0.18	0.24	0.18	0.24	0.09	0.12	1.7	1.1	0.43	0.9	50	80	100	0.00080	6.4
I71B	1000	1600	2000	0.25	0.34	0.25	0.34	0.13	0.18	2.4	1.5	0.60	1.1	50	80	100	0.00100	6.5
I80A	1000	1600	2000	0.37	0.50	0.37	0.50	0.19	0.26	3.5	2.2	0.88	1.3	50	80	100	0.00250	10.5
I80B	1000	1600	2000	0.55	0.75	0.55	0.75	0.28	0.38	5.3	3.3	1.3	1.9	50	80	100	0.00260	11.0
I90S	1000	1600	2000	0.75	1.0	0.75	1.0	0.38	0.52	7.2	4.5	1.8	2.4	50	80	100	0.00450	14.0
I90L	1000	1600	2000	1.1	1.5	1.1	1.5	0.55	0.75	10.5	6.6	2.6	3.4	50	80	100	0.00500	16.0
I100A	1000	1600	2000	1.5	2.0	1.5	2.0	0.75	1.02	14.3	9.0	3.6	4.2	50	80	100	0.01000	21
I100B	1000	1600	2000	1.9	2.5	1.9	2.5	0.93	1.26	17.7	11.1	4.4	5.2	50	80	100	0.01100	23
I112A	1000	1600	2000	2.2	3.0	2.2	3.0	1.1	1.5	21	13.1	5.3	5.6	50	80	100	0.01800	37
I132S	1000	1600	2000	3.0	4.1	3.0	4.1	1.5	2.0	29	17.9	7.2	7.2	50	80	100	0.03000	43
I132M	1000	1600	2000	4.0	5.4	4.0	5.4	2.0	2.7	38	24	9.6	9.8	50	80	100	0.04000	52
I132ML	1000	1600	2000	5.5	7.5	5.5	7.5	2.8	3.7	53	33	13.1	13	50	80	100	0.04200	55
I160M	1000	1600	2000	7.5	10.2	7.5	10.2	3.8	5.1	72	45	17.9	15.0	50	80	100	0.08800	70
I160L	1000	1600	2000	11.0	15.0	11.0	15.0	5.5	7.5	105	66	26	23.5	50	80	100	0.10600	90

**TRIFASE  
THREE-PHASE  
DREHSTROM**

**IA**

Tipo Type Typ	FD Autofrenante in D.C. Brake motor In D.C. Gleichstrom-Bremsmotor				FA Autofrenante in A.C. Brake motor In A.C. Wechselstrom-Bremsmotor				FS Autofrenante in D.C. Brake motor in D.C. Gleichstrom-Bremsmotor				FP Autofrenante in D.C. Brake motor in D.C. Gleichstrom-Bremsmotor			
	CF	Z <sub>0</sub>	PB		CF	Z <sub>0</sub>	PB		CF	Z <sub>0</sub>	PB		CF	Z <sub>0</sub>	PB	
	[Nm]	[1/h]	[W]		[Nm]	[1/h]	[W]		[Nm]	[1/h]	[W]		[Nm]	[1/h]	[W]	
IA56A	1.0	8900	12.0	5.0	—	—	—	—	—	—	—	—	—	—	—	—
IA63A	5.0	8100	20	5.0	5.0	8100	18.0	5.0	4.0	8100	17.0	5.0	7.5	8100	11.5	4.1
IA63B	5.0	6750	20	6.0	5.0	6750	18.0	6.0	4.0	6750	17.0	6.0	7.5	6750	11.5	4.7
IA63C	5.0	5400	20	7.0	5.0	5400	18.0	7.0	4.0	5400	17.0	7.0	7.5	5400	11.5	6.0
IA71B	5.0	5400	20	8.0	5.0	5400	18.0	8.0	4.0	5400	17.0	8.0	7.5	5400	11.5	6.6
IA71C	5.0	5500	20	9.0	5.0	5500	18.0	9.0	4.0	5500	17.0	9.0	7.5	5500	11.5	7.8
IA80B	10.0	5400	25	12.0	10.0	5400	25	12.0	8.0	5400	34	12.0	15.0	5400	16.0	10.4
IA80C	10.0	5100	25	13.0	10.0	5100	25	13.0	8.0	5100	34	13.0	15.0	5100	16.0	11.1
IA80D	10.0	4900	25	14.0	10.0	4900	25	14.0	8.0	4900	34	14.0	15.0	4900	16.0	12.0
IA90L	16.0	4000	30	18.0	20	4000	30	18.0	8.0	4000	34	15.0	15.0	4000	16.0	14.1
IA100A	32	2500	40	25	40	2500	35	27	11.0	2500	40	22	30	2500	21	19.4
IA100B	32	2400	40	28	40	2400	35	30	11.0	2400	40	25	30	2400	21	22
IA112B	60	1400	50	41	80	1400	35	41	11.0	1400	40	36	30	1400	21	33
IA112BL	60	1300	50	43	80	1300	35	43	11.0	1300	40	38	30	1300	21	35
IA132M	80	400	55	67	100	400	45	68	17.0	400	40	59	60	400	28	55
IA132ML	80	400	55	71	100	400	45	72	17.0	400	40	63	60	400	28	59
IA160L	150	300	85	119	150	300	47	117	25	300	45	106	120	300	38	101

Tipo Type Typ	FD Autofrenante in D.C. Brake motor In D.C. Gleichstrom-Bremsmotor				FA Autofrenante in A.C. Brake motor In A.C. Wechselstrom-Bremsmotor				FS Autofrenante in D.C. Brake motor in D.C. Gleichstrom-Bremsmotor				FP Autofrenante in D.C. Brake motor in D.C. Gleichstrom-Bremsmotor			
	CF	Z <sub>0</sub>	PB		CF	Z <sub>0</sub>	PB		CF	Z <sub>0</sub>	PB		CF	Z <sub>0</sub>	PB	
	[Nm]	[1/h]	[W]		[Nm]	[1/h]	[W]		[Nm]	[1/h]	[W]		[Nm]	[1/h]	[W]	
IA50A	—	—	—	—	—	—	—	—	—	—	—	—	—	—	—	—
IA56A	1.0	12500	12.0	5.0	—	—	—	—	—	—	—	—	—	—	—	—
IA56C	1.0	12500	12.0	5.0	—	—	—	—	—	—	—	—	—	—	—	—
IA63A	5.0	10500	20	5.0	5.0	10500	18.0	5.0	4.0	10500	17.0	5.0	7.5	10500	11.5	4.1
IA63B	5.0	10500	20	7.0	5.0	10500	18.0	7.0	4.0	10500	17.0	6.0	7.5	10500	11.5	4.7
IA71A	5.0	18000	20	8.0	5.0	18000	18.0	8.0	4.0	18000	17.0	7.0	7.5	18000	11.5	6.2
IA71B	5.0	16000	20	9.0	5.0	16000	18.0	9.0	4.0	16000	17.0	9.0	7.5	16000	11.5	7.8
IA80A	10.0	9000	25	11.0	10.0	9000	25	11.0	8.0	9000	34	11.0	15.0	9000	16.0	9.1
IA80B	10.0	9000	25	13.0	10.0	9000	25	13.0	8.0	9000	34	12.0	15.0	9000	16.0	10.4
IA80C	10.0	9000	25	14.0	10.0	9000	25	14.0	8.0	9000	34	14.0	15.0	9000	16.0	11.6
IA90S	16.0	13500	30	17.0	20	13500	30	17.0	8.0	13500	34	15.0	15.0	13500	16.0	12.6
IA90L	16.0	11000	30	18.0	20	11000	30	18.0	8.0	11000	34	16.0	15.0	11000	16.0	14.1
IA90LB	16.0	8000	30	20	20	8000	30	20	8.0	8000	34	18.0	15.0	8000	16.0	16.1
IA100A	32	7200	40	26	40	7200	35	28	11.0	7200	40	23	30	7200	21	20
IA100B	32	6000	40	30	40	6000	35	32	11.0	6000	40	27	30	6000	21	24
IA112A	60	3600	50	38	80	3600	35	38	11.0	3600	40	33	30	3600	21	30
IA132S	80	1100	55	56	100	1100	45	57	17.0	1100	40	48	60	1100	28	44
IA132M	80	850	55	66	100	850	45	67	17.0	850	40	57	60	850	28	53
IA132ML	80	800	55	68	100	800	45	69	17.0	800	40	59	60	800	28	55
IA160M	150	750	85	87	150	750	47	85	25	750	45	75	120	750	38	70
IA160L	150	750	85	97	150	750	47	95	25	750	45	83	120	750	38	80

Tipo Type Typ	FD Autofrenante in D.C. Brake motor In D.C. Gleichstrom-Bremsmotor				FA Autofrenante in A.C. Brake motor In A.C. Wechselstrom-Bremsmotor				FS Autofrenante in D.C. Brake motor in D.C. Gleichstrom-Bremsmotor				FP Autofrenante in D.C. Brake motor in D.C. Gleichstrom-Bremsmotor			
	CF	Z <sub>0</sub>	PB		CF	Z <sub>0</sub>	PB		CF	Z <sub>0</sub>	PB		CF	Z <sub>0</sub>	PB	
	[Nm]	[1/h]	[W]		[Nm]	[1/h]	[W]		[Nm]	[1/h]	[W]		[Nm]	[1/h]	[W]	
IA56A	1.0	21500	12.0	5.0	—	—	—	—	—	—	—	—	—	—	—	—
IA63B	5.0	18000	20	6.0	5.0	18000	18.0	6.0	4.0	18000	17.0	6.0	7.5	18000	11.5	4.6
IA71A	5.0	25000	20	8.0	5.0	25000	18.0	8.0	4.0	25000	17.0	8.0	7.5	25000	11.5	6.8
IA71B	5.0	24000	20	8.0	5.0	24000	18.0	8.0	4.0	24000	17.0	8.0	7.5	24000	11.5	6.9
IA80A	10.0	16000	25	13.0	10.0	16000	25	13.0	8.0	16000	34	13.0	15.0	16000	16.0	11.1
IA80B	10.0	15000	25	14.0	10.0	15000	25	14.0	8.0	15000	34	14.0	15.0	15000	16.0	11.6
IA90S	16.0	13500	30	18.0	20	13500	30	18.0	8.0	13500	34	17.0	15.0	13500	16.0	14.6
IA90L	16.0	13000	30	19.5	20	13000	30	19.5	8.0	13000	34	18.5	15.0	13000	16.0	16.6
IA100A	32	7500	40	28	40	7500	35	30	11.0	7500	40	25	30	7500	21	22
IA100B	32	7000	40	30	40	7000	35	32	11.0	7000	40	27	30	7000	21	24
IA112A	60	5500	50	46	80	5500	35	46	11.0	5500	40	41	30	5500	21	38
IA132S	80	1600	55	56	100	1600	45	57	17.0	1600	40	48	60	1600	28	44
IA132M	80	1350	55	65	100	1350	45	66	17.0	1350	40	57	60	1350	28	53
IA132ML	80	1100	55	68	100	1100	45	69	17.0	1100	40	60	60	1100	28	56
IA160M	150	1000	85	89	150	1000	47	87	25	1000	45	75	120	1000	38	72
IA160L	150	850	85	109	150	850	47	107	25	850	45	95	120	850	38	92

D

TRIFASE  
THREE-PHASE  
DREHSTROM

2/4 P 3000/1500 min<sup>-1</sup>

Unico avvolgimento  
Single winding  
Einlagige Wicklung

Servoventilazione / Blower  
Servobelüftung  
230V/50HZ

Tipo Type Typ	Pn		n <sub>n</sub> [min <sup>-1</sup> ]	I <sub>n</sub> (400 V) [A]	l <sub>a</sub> l <sub>n</sub>	Ca Cn	Cn [Nm]	J <sub>m</sub> [Kgm <sup>2</sup> ]	Kg	P <sub>v</sub> [W]	VB [m <sup>3</sup> /min]
	[kW]	[HP]									
D56B	0.11/0.070	0.15/0.10	2760/1360	0.65/0.60	3.0/2.6	1.3/1.5	0.40/0.73	0.00015	2.7	15.0	0.60
D63C	0.22/0.14	0.30/0.20	2760/1360	0.75/0.70	3.2/2.8	1.4/1.6	0.80/1.3	0.00040	4.4	12.0	0.70
D71A	0.33/0.22	0.45/0.30	2760/1380	1.2/0.80	3.8/3.2	1.8/1.9	1.3/1.9	0.00050	5.9	15.0	2.4
D71B	0.45/0.30	0.60/0.40	2760/1390	1.5/1.2	4.2/3.3	1.8/1.9	1.5/2.2	0.00080	6.3	15.0	2.4
D71C	0.55/0.37	0.75/0.50	2760/1390	1.6/1.4	4.2/3.3	1.8/1.9	1.8/2.6	0.00090	7.5	15.0	2.4
D80A	0.60/0.45	0.80/0.60	2780/1390	2.4/1.4	4.0/3.9	2.0/1.9	2.0/3.0	0.00140	8.7	15.0	2.4
D80B	0.80/0.60	1.2/0.90	2780/1400	2.4/1.6	4.8/4.2	2.1/2.0	2.8/3.9	0.00170	9.9	15.0	2.4
D80C	1.1/0.80	1.5/1.1	2790/1400	3.0/2.2	4.8/4.3	1.9/1.9	3.8/5.8	0.00230	11.2	15.0	2.4
D90S	1.4/1.0	1.9/1.4	2810/1410	4.0/2.6	4.9/4.6	2.0/1.9	4.7/7.9	0.00330	12.5	38	5.4
D90L	1.7/1.3	2.3/1.8	2830/1420	5.1/3.6	5.2/4.9	2.2/2.1	6.4/9.3	0.00400	14.0	38	5.4
D90LB	2.2/1.5	3.0/2.0	2840/1420	5.5/4.0	5.3/5.0	2.1/2.0	7.3/9.9	0.00500	16.0	38	5.4
D100A	2.4/1.8	3.5/2.5	2840/1420	5.7/4.5	5.8/5.6	2.3/2.1	8.6/12.6	0.00750	20	38	5.4
D100B	3.3/2.5	4.5/3.5	2850/1430	8.0/6.5	6.8/6.3	2.4/2.2	11.3/17.5	0.00850	23	38	5.4
D112A	4.5/3.3	6.0/4.6	2890/1440	11.0/8.7	6.9/6.3	2.3/2.1	15.2/23	0.01300	33	38	5.4
D112B	5.5/4.5	7.6/6.0	2850/1430	13.8/10.8	7.2/6.7	2.1/2.0	16.0/27	0.01600	36	38	5.4
D132S	5.5/4.5	7.6/6.0	2890/1450	13.8/10.8	7.0/6.4	2.4/2.2	18.5/30	0.02400	44	38	5.4
D132M	7.5/6.0	10.0/8.0	2900/1450	18.6/15.5	7.3/6.2	2.4/2.4	26/44	0.03300	53	38	5.4
D160M	14.0/11.0	19.0/15.0	2880/1450	28/20	5.6/5.3	2.4/2.3	47/72	0.06200	90	115	27
D160L	18.5/14.0	25/18.5	2920/1450	36/28	6.2/5.8	2.6/2.5	60/92	0.07400	101	115	27

4/8 P 1500/750 min<sup>-1</sup>

Unico avvolgimento  
Single winding  
Einlagige Wicklung

Servoventilazione / Blower  
Servobelüftung  
230V/50HZ

Tipo Type Typ	Pn		n <sub>n</sub> [min <sup>-1</sup> ]	I <sub>n</sub> (400 V) [A]	l <sub>a</sub> l <sub>n</sub>	Ca Cn	Cn [Nm]	J <sub>m</sub> [Kgm <sup>2</sup> ]	Kg	P <sub>v</sub> [W]	VB [m <sup>3</sup> /min]
	[kW]	[HP]									
D63C	0.09/0.04	0.12/0.06	1360/660	0.60/0.90	3.3/2.3	1.0/1.3	0.75/0.80	0.00090	4.4	12.0	0.70
D71B	0.18/0.11	0.25/0.15	1370/670	0.80/0.90	3.4/2.4	1.1/1.4	1.25/1.4	0.00180	6.3	15.0	2.4
D71C	0.30/0.15	0.40/0.2	1380/670	1.1/1.2	3.5/2.4	1.4/1.6	1.75/1.9	0.00200	7.5	15.0	2.4
D80A	0.37/0.18	0.50/0.25	1380/670	1.2/1.3	3.5/2.4	1.5/1.6	2.9/2.53	0.00250	8.7	15.0	2.4
D80B	0.55/0.30	0.75/0.40	1380/680	1.6/1.7	3.6/2.5	1.6/1.9	3.6/3.7	0.00280	9.9	15.0	2.4
D80C	0.75/0.37	1.0/0.50	1360/670	2.3/2.4	4.0/3.3	1.6/1.8	5.2/5.1	0.00300	10.5	15.0	2.4
D90S	0.75/0.37	1.0/0.50	1380/680	2.2/2.3	4.0/3.2	1.7/2.0	5.3/5.1	0.00430	12.5	38	5.4
D90L	0.90/0.50	1.3/0.70	1400/690	2.3/2.4	4.4/3.5	1.8/2.3	6.7/7.4	0.00550	14.0	38	5.4
D90LB	1.1/0.60	1.5/0.80	1390/680	3.4/3.2	4.2/3.6	1.7/2.1	7.5/8.4	0.00550	16.5	38	5.4
D100A	1.4/0.70	1.9/0.90	1410/700	3.5/2.6	4.0/3.3	1.8/1.9	9.8/9.5	0.00770	20.3	38	5.4
D100B	1.6/0.90	2.2/1.2	1420/710	3.8/3.5	5.0/4.0	2.0/1.7	11.5/12.6	0.00860	22	38	5.4
D112A	1.7/1.0	2.4/1.4	1420/700	5.5/4.8	5.5/4.1	1.7/1.9	12.2/14.4	0.01200	32	38	5.4
D112B	2.2/1.4	3.0/1.9	1440/710	5.2/5.0	5.3/4.0	1.5/1.7	14.6/18.9	0.01500	37	38	5.4
D132S	3.7/2.2	5.0/3.0	1430/720	8.0/7.0	5.0/3.5	2.0/2.1	25/27	0.03000	46	38	5.4
D132M	5.1/3.0	7.0/4.0	1440/710	11.0/9.0	5.1/3.6	1.9/2.0	34/40	0.04000	56	38	5.4
D132ML	6.0/3.7	8.0/5.0	1430/700	15.0/12.0	5.3/3.9	1.8/1.7	40/51	0.05000	58	38	5.4
D160M	7.0/5.0	9.5/6.8	1430/700	18.0/14.0	5.2/4.0	2.0/2.1	63/68	0.08800	74	115	27
D160L	10.0/7.0	13.6/9.5	1445/720	21/17.0	5.3/4.4	2.0/2.2	73/86	0.11200	90	115	27

4/6 P 1500/1000 min<sup>-1</sup>





Doppio avvolgimento  
Double winding  
Doppellagige Wicklung





Servoventilazione / Blower  
Servobelüftung  
230V/50HZ





Tipo Type Typ	Pn		n <sub>n</sub> [min <sup>-1</sup> ]	I <sub>n</sub> (400 V) [A]	l <sub>a</sub> l <sub>n</sub>	Ca Cn	Cn [Nm]	J <sub>m</sub> [Kgm <sup>2</sup> ]	Kg	P <sub>v</sub> [W]	VB [m <sup>3</sup> /min]
	[kW]	[HP]									
D71B	0.30/0.20	0.40/0.30	1380/870	1.1/1.0	3.4/2.8	1.2/1.0	1.9/2.2	0.00090	6.3	15.0	2.4
D71C	0.37/0.22	0.50/0.30	1380/880	1.3/1.2	3.4/2.7	1.3/1.1	2.5/2.2	0.00100	7.5	15.0	2.4
D80A	0.37/0.25	0.50/0.35	1400/900	1.3/1.2	3.8/3.0	1.3/1.2	2.5/2.6	0.00200	8.7	15.0	2.4
D80B	0.55/0.45	0.75/0.60	1410/910	1.8/1.5	3.8/3.1	1.3/1.3	3.5/4.3	0.00200	9.9	15.0	2.4
D90S	0.75/0.50	1.0/0.70	1420/920	2.3/1.8	4.2/3.2	1.5/1.4	5.4/5.5	0.00350	12.5	38	5.4
D90L	0.95/0.60	1.3/0.80	1430/930	3.2/2.7	4.5/3.5	1.6/1.5	6.9/6.4	0.00450	14.0	38	5.4
D90LB	1.1/0.75	1.5/1.0	1430/930	3.5/3.3	4.5/3.6	1.6/1.6	7.5/7.9	0.00500	16.0	38	5.4
D100A	1.3/0.90	1.8/1.2	1430/940	3.9/3.5	5.3/4.2	1.7/1.6	8.6/10.2	0.00900	19	38	5.4
D100B	1.5/1.1	2.0/1.5	1430/940	4.5/3.8	5.4/4.4	1.9/1.5	9.8/10.2	0.01000	22	38	5.4
D112A	1.8/1.3	2.5/1.8	1450/940	4.9/4.0	6.2/4.8	1.8/1.7	12.5/14.5	0.01500	32	38	5.4
D112B	2.6/1.8	3.5/2.5	1440/950	6.8/5.1	5.5/4.0	1.6/1.4	17.0/18.0	0.01600	38	38	5.4
D132S	3.7/2.8	5.0/3.8	1430/940	10.0/7.0	5.8/4.5	1.9/1.7	25/29	0.03000	44	38	5.4
D132M	5.5/4.0	7.5/5.5	1450/950	12.0/10.0	6.0/5.0	2.0/2.0	36/40	0.03300	52	38	5.4
D160M	9.5/6.6	13.0/9.0	1460/960	17.0/13.0	6.5/5.0	2.0/1.9	63/66	0.08800	74	115	27
D160L	11.0/7.5	15.0/10.0	1420/930	20.0/15.0	6.8/5.5	1.8/1.8	74/75	0.11200	90	115	27

TRIFASE  
THREE-PHASE  
DREHSTROM

DA

Tipo Type Typ	FD Autofrenante in D.C. Brake motor In D.C. Gleichstrom-Bremsmotor				FA Autofrenante in A.C. Brake motor In A.C. Wechselstrom-Bremsmotor				FS Autofrenante in D.C. Brake motor in D.C. Gleichstrom-Bremsmotor				FP Autofrenante in D.C. Brake motor in D.C. Gleichstrom-Bremsmotor			
	CF	Z <sub>0</sub>	PB		CF	Z <sub>0</sub>	PB		CF	Z <sub>0</sub>	PB		CF	Z <sub>0</sub>	PB	
	[Nm]	[1/h]	[W]		[Nm]	[1/h]	[W]		[Nm]	[1/h]	[W]		[Nm]	[1/h]	[W]	
DA56B	1.0	5500/6500	12	4.0	—	—	—	—	—	—	—	—	—	—	—	—
DA63C	5.0	4500/5500	20	6.0	5.0	4500/5500	18.0	6.0	4.0	4500/5500	17.0	5.4	7.5	4500/5500	11.5	4.8
DA71A	5.0	7500/16000	20	8.0	5.0	7500/16000	18.0	8.0	4.0	7500/16000	17.0	7.2	7.5	7500/16000	11.5	6.3
DA71B	5.0	6000/14500	20	8.0	5.0	6000/14500	18.0	8.0	4.0	6000/14500	17.0	7.6	7.5	6000/14500	11.5	6.6
DA71C	5.0	5500/14000	20	9.0	5.0	5500/14000	18.0	9.0	4.0	5500/14000	17.0	8.8	7.5	5500/14000	11.5	7.9
DA80A	10.0	2700/9000	25	11.0	10.0	2700/9000	25	11.0	8.0	2700/9000	34	10.9	15	2700/9000	16.0	9.3
DA80B	10.0	2700/9000	25	13.0	10.0	2700/9000	25	13.0	8.0	2700/9000	34	12.1	15.0	2700/9000	16.0	10.5
DA80C	10.0	2500/8500	25	14.0	10.0	2500/8500	25	14.0	8.0	2500/8500	34	13.4	15.0	2500/8500	16.0	11.8
DA90S	16.0	2500/8500	30	17.0	20	2500/8500	30	17.0	8.0	2500/8500	34	14.7	15.0	2500/8500	16.0	13.1
DA90L	16.0	2300/8000	30	19.0	20	2300/8000	30	19.0	8.0	2300/8000	34	16.2	15.0	2300/8000	16.0	14.6
DA90LB	16.0	2300/7800	30	21	20	2300/7800	30	21	8.0	2300/7800	34	18.2	15.0	2300/7800	16.0	16.6
DA100A	32	1600/6000	40	27	40	1600/6000	35	29	11.0	1600/6000	40	24	30	1600/6000	21	21
DA100B	32	1500/5500	40	30	40	1500/5500	35	32	11.0	1500/5500	40	26	30	1500/5500	21	23
DA112A	60	800/3400	50	40	80	800/3400	35	42	11.0	800/3400	40	37	30	800/3400	21	34
DA112B	60	750/3200	50	43	80	750/3200	35	45	11.0	750/3200	40	40	30	750/3200	21	37
DA132S	80	350/900	55	57	100	350/900	45	58	17.0	350/900	40	49	60	350/900	28	45
DA132M	80	350/850	55	66	100	350/850	45	67	17.0	350/850	40	58	60	350/850	28	54
DA160M	150	270/720	85	110	150	270/720	47	114	25	270/720	45	97	120	270/720	38	92
DA160L	150	225/675	85	121	150	225/675	47	124	25	225/675	45	108	120	225/675	38	103

Tipo Type Typ	FD Autofrenante in D.C. Brake motor in D.C. Gleichstrom-Bremsmotor				FA Autofrenante in A.C. Brake motor In A.C. Wechselstrom-Bremsmotor				FS Autofrenante in D.C. Brake motor in D.C. Gleichstrom-Bremsmotor				FP Autofrenante in D.C. Brake motor in D.C. Gleichstrom-Bremsmotor			
	CF	Z <sub>0</sub>	PB		CF	Z <sub>0</sub>	PB		CF	Z <sub>0</sub>	PB		CF	Z <sub>0</sub>	PB	
	[Nm]	[1/h]	[W]		[Nm]	[1/h]	[W]		[Nm]	[1/h]	[W]		[Nm]	[1/h]	[W]	
DA63C	5.0	9900/27000	20	6.0	5.0	9900/27000	18.0	6.0	4.0	9900/27000	17.0	—	7.5	9900/27000	11.5	—
DA71B	5.0	9900/27000	20	8.0	5.0	9900/27000	18.0	8.0	4.0	9900/27000	17.0	7.6	7.5	9900/27000	11.5	6.7
DA71C	5.0	9000/25000	20	9.0	5.0	9000/25000	18.0	9.0	4.0	9000/25000	17.0	8.8	7.5	9000/25000	11.5	7.9
DA80A	10.0	8000/20000	25	11.0	10.0	8000/20000	25	11.0	8.0	8000/20000	34	10.9	15.0	8000/20000	16.0	9.3
DA80B	10.0	8000/20000	25	15.0	10.0	8000/20000	25	15.0	8.0	8000/20000	34	12.1	15.0	8000/20000	16.0	10.5
DA80C	10.0	7500/19000	25	15.6	10.0	7500/19000	25	15.6	8.0	7500/19000	34	12.7	15.0	7500/19000	16.0	11.1
DA90S	16.0	9000/13500	30	17.0	20	9000/13500	30	17.0	8.0	9000/13500	34	14.7	15.0	9000/13500	16.0	13.1
DA90L	16.0	7500/11500	30	19.0	20	7500/11500	30	19.0	8.0	7500/11500	34	16.2	15.0	7500/11500	16.0	14.6
DA90LB	16.0	7000/10500	30	22	20	7000/10500	30	22	8.0	7000/10500	34	18.2	15.0	7000/10500	16.0	17.1
DA100A	32	3700/7700	40	27	40	3700/7700	35	29	11.0	3700/7700	40	24	30	3700/7700	21	21
DA100B	32	3500/7400	40	29	40	3500/7400	35	31	11.0	3500/7400	40	26	30	3500/7400	21	23
DA112A	60	3400/7200	50	41	80	3400/7200	35	41	11.0	3400/7200	40	36	30	3400/7200	21	33
DA112B	60	3200/6800	50	46	80	3200/6800	35	46	11.0	3200/6800	40	41	30	3200/6800	21	38
DA132S	80	900/1600	55	59	100	900/1600	45	60	17.0	900/1600	40	51	60	900/1600	28	47
DA132M	80	900/1600	55	69	100	900/1600	45	70	17.0	900/1600	40	61	60	900/1600	28	57
DA132ML	80	900/1600	55	71	100	900/1600	45	72	17.0	900/1600	40	63	60	900/1600	28	59
DA160M	150	850/1500	85	93	150	850/1500	47	91	25	850/1500	45	81	120	850/1500	38	76
DA160L	150	850/1500	85	109	150	850/1500	47	107	25	850/1500	45	97	120	850/1500	38	92

Tipo Type Typ	FD Autofrenante in D.C. Brake motor in D.C. Gleichstrom-Bremsmotor				FA Autofrenante in A.C. Brake motor In A.C. Wechselstrom-Bremsmotor				FS Autofrenante in D.C. Brake motor in D.C. Gleichstrom-Bremsmotor				FP Autofrenante in D.C. Brake motor in D.C. Gleichstrom-Bremsmotor			
	CF	Z <sub>0</sub>	PB		CF	Z <sub>0</sub>	PB		CF	Z <sub>0</sub>	PB		CF	Z <sub>0</sub>	PB	
	[Nm]	[1/h]	[W]		[Nm]	[1/h]	[W]		[Nm]	[1/h]	[W]		[Nm]	[1/h]	[W]	
DA71B	5	6700/13500	20	8	5	6700/13500	18	8	4	6700/13500	17	-	7,5	6700/13500	11,5	-
DA71C	5	6700/13500	20	9	5	6700/13500	18	9	4	6700/13500	17	8,8	7,5	6700/13500	11,5	7,85
DA80A	10	6300/13500	25	11	10	6300/13500	25	11	8	6300/13500	34	10,9	7,5	6300/13500	16	9,3
DA80B	10	6300/13500	25	13	10	6300/13500	25	13	8	6300/13500	34	12,1	15	6300/13500	16	10,5
DA90S	16	5400/11000	30	17	20	5400/11000	30	17	8	5400/11000	34	14,7	15	5400/11000	16	13,1
DA90L	16	5000/9000	30	19	20	5000/9000	30	19	8	5000/9000	34	16,2	15	5000/9000	16	14,6
DA90LB	16	4500/8000	30	21	20	4500/8000	30	21	8	4500/8000	34	18,2	15	4500/8000	16	16,6
DA100A	32	1800/4500	40	25,5	40	1800/4500	35	27,5	11	1800/4500	40	22,5	30	1800/4500	21	19,9
DA100B	32	1600/4000	40	29	40	1600/4000	35	33	11	1600/4000	40	25,5	30	1600/4000	21	22,9
DA112A	60	1500/3600	50	41	80	1500/3600	35	41	11	1500/3600	40	35,7	30	1500/3600	21	32,9
DA112B	60	1500/3600	50	45	80	1500/3600	35	47	11	1500/3600	40	41,73	30	1500/3600	21	38,9
DA132S	80	540/900	55	57	100	540/900	45	58	17	540/900	40	48,5	60	540/900	28	44,9
DA132M	80	540/900	55	65	100	540/900	45	66	17	540/900	40	56,5	60	540/900	28	52,9
DA160M	150	450/800	85	93	150	450/800	47	98	25	450/800	45	81	120	450/800	38	76
DA160L	150	450/800	85	109	150	450/800	47	114	25	450/800	45	97	120	450/800	38	92

TRIFASE  
THREE-PHASE  
DREHSTROM

6/8 P 1000/750 min<sup>-1</sup>

Doppio avvolgimento  
Double winding  
Doppellagige Wicklung

Servoventilazione / Blower  
Servobelüftung  
230V/50HZ

Tipo Type Typ	Pn		n <sub>n</sub> [min <sup>-1</sup> ]	I <sub>n</sub> (400 V) [A]	I <sub>a</sub> I <sub>n</sub>	C <sub>a</sub> C <sub>n</sub>	C <sub>n</sub> [Nm]	J <sub>m</sub> [Kgm <sup>2</sup> ]	Kg	P <sub>v</sub> [W]	VB [m <sup>3</sup> /min]
	[kW]	[HP]									
D63C	0.07/0.03	0.10/0.05	890/660	0.50/0.40	2.2/1.8	1.8/1.8	0.80/0.43	0.00060	4.4	17.0	2.6
D71C	0.18/0.09	0.25/0.12	900/670	0.90/0.80	2.3/1.9	1.9/1.9	1.9/1.2	0.00100	6.6	17.0	2.6
D80A	0.20/0.11	0.28/0.15	900/680	1.0/0.90	2.5/2.0	2.0/2.0	2.0/1.4	0.00220	8.7	38	5.4
D80B	0.37/0.25	0.50/0.35	900/670	1.8/1.4	3.5/2.4	2.0/1.5	3.7/3.4	0.00250	11.0	38	5.4
D90S	0.37/0.25	0.50/0.35	920/690	1.6/1.3	3.4/2.2	2.2/1.7	3.7/3.4	0.00360	12.5	38	5.4
D90L	0.55/0.37	0.75/0.50	920/690	2.1/1.8	3.4/2.2	2.1/2.0	5.7/4.9	0.00450	14.0	38	5.4
D90LB	0.75/0.55	1.0/0.75	910/690	3.0/2.2	3.6/2.3	3.6/2.3	7.8/7.6	0.00500	18.0	38	5.4
D100A	0.75/0.55	1.0/0.75	930/700	2.8/2.1	3.0/2.1	1.8/1.6	7.9/7.5	0.00900	19.0	38	5.4
D100B	0.90/0.75	1.3/1.0	940/710	3.2/2.8	2.6/1.9	1.9/1.7	10.5/9.9	0.01000	22	38	5.4
D112A	1.2/0.9	1.7/1.3	940/710	4.0/3.5	3.6/2.4	2.1/1.9	14.0/14.0	0.01500	32	38	5.4
D132S	2.2/1.3	3.0/1.8	950/710	6.0/4.6	4.4/3.5	1.9/1.4	22/18.5	0.03000	45	38	5.4
D132M	3.0/1.5	4.0/2.0	960/715	7.0/5.0	5.0/4.0	2.0/1.8	30/20	0.04200	55	38	5.4
D160M	5.5/2.5	7.3/3.3	960/730	12.5/7.0	5.6/4.5	2.1/2.1	54/33	0.08800	70	115	27
D160L	7.5/4.0	10.0/5.3	970/720	15.5/9.2	5.8/4.5	2.0/2.0	74/53	0.10600	90	115	27

2/6 P 3000/1000 min<sup>-1</sup>

Doppio avvolgimento  
Double winding  
Doppellagige Wicklung

Servoventilazione / Blower  
Servobelüftung  
230V/50HZ

Tipo Type Typ	Pn		n <sub>n</sub> [min <sup>-1</sup> ]	I <sub>n</sub> (400 V) [A]	I <sub>a</sub> I <sub>n</sub>	C <sub>a</sub> C <sub>n</sub>	C <sub>n</sub> [Nm]	J [Kgm <sup>2</sup> ]	Kg	P <sub>v</sub> [W]	VB [m <sup>3</sup> /min]
	[kW]	[HP]									
D63C	0.18/0.09	0.25/0.12	2760/770	0.80/0.70	3.0/1.3	1.8/1.5	0.6/1.0	0.00040	4.5	17.0	2.6
D71C	0.25/0.15	0.35/0.20	2800/760	0.90/0.85	3.2/1.4	1.9/1.6	0.78/1.4	0.00090	6.3	17.0	2.6
D80A	0.55/0.20	0.75/0.30	2800/770	1.4/1.2	3.8/1.5	2.0/1.6	1.8/2.4	0.00140	8.7	38	5.4
D80B	0.75/0.3	1.0/0.40	2830/790	1.9/1.6	4.1/1.6	2.2/2.0	2.4/3.4	0.00170	9.9	38	5.4
D90S	1.0/0.48	1.4/0.65	2840/830	2.4/1.85	4.4/1.8	2.1/2.1	3.4/4.8	0.00330	12.5	38	5.4
D90L	1.4/0.65	1.8/0.90	2840/850	3.1/2.3	5.1/1.9	2.3/2.0	4.4/7.2	0.00450	14.0	38	5.4
D90LB	1.8/0.90	2.5/1.2	2850/860	4.3/3.1	5.7/2.1	2.0/2.0	6.0/10.0	0.00500	16.0	38	5.4
D100A	1.8/0.90	2.5/1.2	2880/900	4.2/2.9	5.5/1.9	2.2/2.1	5.6/9.8	0.00900	19.0	38	5.4
D100B	2.2/1.1	3.0/1.5	2890/900	4.9/3.3	6.4/2.0	2.3/2.1	7.2/11.5	0.01000	22	38	5.4
D112A	3.0/1.5	4.0/2.0	2900/910	6.8/4.6	6.7/2.1	2.4/2.0	9.3/15.3	0.01500	32	38	5.4
D132S	4.0/1.8	5.4/2.4	2940/900	12.0/6.5	7.0/2.2	2.6/2.0	13.0/19.0	0.03000	44	38	5.4
D132M	5.9/2.6	8.0/3.5	2930/920	14.0/7.6	7.2/2.6	2.8/2.0	19.8/26	0.04000	53	38	5.4
D160M	7.5/5.5	10.0/7.3	2900/960	19/12.5	7.0/5.6	2.6/2.1	24/54	0.08800	70	115	27
D160L	11.0/7.5	15.0/10.0	2900/970	24/15.5	7.0/5.8	2.8/2.3	36/74	0.10600	90	115	27

2/8 P 3000/750 min<sup>-1</sup>

Doppio avvolgimento  
Double winding  
Doppellagige Wicklung

Servoventilazione / Blower  
Servobelüftung  
230V/50HZ

Tipo Type Typ	Pn		n <sub>n</sub> [min <sup>-1</sup> ]	I <sub>n</sub> (400 V) [A]	I <sub>a</sub> I <sub>n</sub>	C <sub>a</sub> C <sub>n</sub>	C <sub>n</sub> [Nm]	J [Kgm <sup>2</sup> ]	Kg	P <sub>v</sub> [W]	VB [m <sup>3</sup> /min]
	[kW]	[HP]									
D63C	0.18/0.06	0.25/0.08	2780/660	0.8/0.5	3.5/2.2	1.1/1.7	0.62/0.77	0.00040	4.4	17.0	2.6
D71C	0.30/0.09	0.40/0.12	2790/675	1.1/0.8	4.1/2.3	1.1/1.8	0.86/1.16	0.00080	6.3	17.0	2.6
D80A	0.55/0.11	0.75/0.15	2800/680	1.8/1.1	4.2/2.4	1.4/1.9	1.82/1.38	0.00140	8.7	38	5.4
D80B	0.75/0.15	1.0/0.2	2820/680	2.3/1.2	4.5/2.4	1.3/1.9	2.4/2.6	0.00170	9.9	38	5.4
D90S	1.0/0.25	1.4/0.33	2840/690	2.7/1.4	4.8/2.5	1.4/1.7	3.4/3.4	0.00350	12.5	38	5.4
D90L	1.35/0.33	1.8/0.45	2860/690	3.6/1.8	4.8/2.6	1.4/1.7	4.3/4.4	0.00450	14.0	38	5.4
D90LB	1.7/0.40	2.3/0.55	2860/680	4.9/2.5	5.6/2.9	1.3/1.6	5.6/5.6	0.00500	16.0	38	5.4
D100A	1.8/0.50	2.5/0.70	2880/700	5.0/2.4	5.8/3.0	1.5/1.7	5.6/6.9	0.00900	19.0	38	5.4
D100B	2.2/0.60	3.0/0.8	2880/700	5.0/2.3	6.2/3.6	1.6/1.9	7.2/8.3	0.01000	22	38	5.4
D112A	3.0/0.75	4.0/1.0	2900/710	6.8/3.3	6.5/3.6	1.7/1.9	9.3/9.8	0.01500	33	38	5.4
D132S	3.7/1.1	5.0/1.5	2920/720	10.0/6.0	7.0/4.2	1.8/1.9	13.1/15	0.03000	44	38	5.4
D132M	5.5/1.3	7.5/1.75	2920/720	12.0/7.8	7.5/4.8	2.0/1.9	18.3/17.5	0.04000	52	38	5.4
D160M	7.5/4.0	10.0/5.5	2900/720	19/11.5	7.0/5.0	2.6/1.8	24/53	0.08800	70	115	27
D160L	11.0/5.5	15.0/7.5	2900/725	24/13.5	7.0/5.5	2.8/1.8	36/72	0.10600	90	115	27

2/12 P 3000/500 min<sup>-1</sup>

V 400/50 Hz

Doppio avvolgimento  
Double winding  
Doppellagige Wicklung

Servoventilazione / Blower  
Servobelüftung  
230V/50HZ

Tipo Type Typ	Pn		n <sub>n</sub> [min <sup>-1</sup> ]	I <sub>n</sub> (400 V) [A]	I <sub>a</sub> I <sub>n</sub>	C <sub>a</sub> C <sub>n</sub>	C <sub>n</sub> [Nm]	J <sub>m</sub> [Kgm <sup>2</sup> ]	Kg	P <sub>v</sub> [W]	VB [m <sup>3</sup> /min]
	[kW]	[HP]									
D71C	0.37/0.05	0.50/0.07	2770/440	1.1/0.9	3.0/1.4	1.5/2.0	1.2/1.0	0.00090	7.8	17.0	2.6
D80B	0.37/0.07	0.50/0.10	2780/440	1.0/0.88	3.2/1.5	1.7/2.1	1.3/1.25	0.00140	8.8	38	5.4
D80C	0.55/0.09	0.75/0.12	2790/450	1.5/1.0	3.4/1.8	1.8/2.7	1.8/1.85	0.00170	10.5	38	5.4
D90L	0.75/0.11	1.0/0.15	2850/460	2.0/1.4	4.8/2.0	1.9/2.9	2.4/2.3	0.00180	14.0	38	5.4
D90LB	1.1/0.15	1.5/0.20	2880/470	2.9/1.5	4.6/2.0	1.9/2.9	3.7/3.2	0.00260	14.0	38	5.4
D100BL	1.8/0.37	2.5/0.50	2850/450	4.1/2.0	5.0/2.1	3.0/2.8	6.0/7.7	0.01300	22	38	5.4
D112A	3.0/0.75	4.0/1.0	2900/450	6.8/3.0	6.5/3.0	1.7/2.8	9.3/16.0	0.01800	33	38	5.4
D132S	3.7/0.88	5.0/1.1	2920/455	10.0/6.0	7.0/4.0	1.8/2.5	13.1/18.5	0.03000	44	38	5.4
D132M	5.5/1.1	7.5/1.5	2920/455	12.0/6.1	7.5/4.0	2.0/2.2	18.3/23	0.04000	52	38	5.4
D160M	7.5/1.5	10.0/2.0	2900/460	19.0/6.5	7.3/4.0	2.6/1.8	24/31	0.08800	80	115	27
D160L	11.0/3.0	15.0/4.0	2900/460	24/11.0	7.0/4.0	2.8/2.0	36/63	0.10600	90	115	27

DA

TRIFASE THREE-PHASE DREHSTROM

Table with 16 columns (Typo Type, CF, Z0, PB, Kg) and 4 sub-sections (FD, FA, FS, FP) for various brake motor types.

Table with 16 columns (Typo Type, CF, Z0, PB, Kg) and 4 sub-sections (FD, FA, FS, FP) for various brake motor types.


Table with 16 columns (Typo Type, CF, Z0, PB, Kg) and 4 sub-sections (FD, FA, FS, FP) for various brake motor types.

Table with 16 columns (Typo Type, CF, Z0, PB, Kg) and 4 sub-sections (FD, FA, FS, FP) for various brake motor types.


TRIFASE  
THREE-PHASE  
DREHSTROM

S autoventilati / S self-cooled / S eigenbelüftete


4 P 1500 min<sup>-1</sup>

Tipo Type Typ	P <sub>n</sub>				n <sub>n</sub> [min <sup>-1</sup> ]				I <sub>n</sub> (400V) [A]	I <sub>n</sub> (460V) [A]	η %		cos φ		C <sub>n</sub> [Nm]		J <sub>m</sub> [Kgm <sup>2</sup> ]	
	[kW] 400V 50Hz	[HP] 400V 50Hz	[kW] 460V 60Hz	[HP] 460V 60Hz	50Hz Min.	60Hz Min.	50Hz Min.	60Hz Min.			50Hz	60Hz	50Hz	60Hz	50Hz	60Hz		
S71C	0.07	0.09	0.08	0.11	200	240	1200	1440	1.0	1.0	40	41	0.26	0.30	0.56	0.56	0.00090	7.4
S80C	0.12	0.16	0.14	0.19	200	240	1200	1440	1.2	1.2	42	43	0.34	0.40	0.96	0.96	0.00200	10.5
S90S	0.15	0.20	0.18	0.24	200	240	1200	1440	1.4	1.4	45	46	0.34	0.40	1.19	1.19	0.00330	12.0
S90LB	0.18	0.24	0.22	0.29	200	240	1200	1440	1.6	1.6	46	48	0.35	0.41	1.43	1.43	0.00500	15.5
S100B	0.25	0.34	0.30	0.40	200	240	1200	1440	1.8	1.8	47	48	0.43	0.50	1.99	1.99	0.00850	21.0
S112A	0.37	0.50	0.44	0.60	200	240	1200	1440	2.2	2.2	48	49	0.51	0.59	2.95	2.95	0.01300	29.0

6 P 1000 min<sup>-1</sup>

Tipo Type Typ	P <sub>n</sub>				n <sub>n</sub> [min <sup>-1</sup> ]				I <sub>n</sub> (400V) [A]	I <sub>n</sub> (460V) [A]	η %		cos φ		C <sub>n</sub> [Nm]		J <sub>m</sub> [Kgm <sup>2</sup> ]	
	[kW] 400V 50Hz	[HP] 400V 50Hz	[kW] 460V 60Hz	[HP] 460V 60Hz	50Hz Min.	60Hz Min.	50Hz Min.	60Hz Min.			50Hz	60Hz	50Hz	60Hz	50Hz	60Hz		
S71C	0.09	0.12	0.11	0.14	130	156	800	960	1.2	1.2	36	37	0.30	0.35	1.1	1.1	0.00100	6.5
S80C	0.15	0.20	0.18	0.24	130	156	800	960	1.4	1.4	41	43	0.37	0.44	1.8	1.8	0.00260	11.0
S90S	0.18	0.24	0.22	0.29	130	156	800	960	1.4	1.4	43	44	0.43	0.50	2.2	2.2	0.00350	12.0
S90LB	0.25	0.34	0.30	0.40	130	156	800	960	1.6	1.6	44	45	0.52	0.60	3.0	3.0	0.00500	16.0
S100B	0.37	0.50	0.44	0.60	130	156	800	960	2.0	2.0	46	48	0.58	0.67	4.4	4.4	0.01000	21
S112A	0.55	0.74	0.66	0.89	130	156	800	960	2.4	2.4	48	49	0.69	0.80	6.6	6.6	0.01500	30





8 P 750 min<sup>-1</sup>





Tipo Type Typ	P <sub>n</sub>				n <sub>n</sub> [min <sup>-1</sup> ]				I <sub>n</sub> (400V) [A]	I <sub>n</sub> (460V) [A]	η %		cos φ		C <sub>n</sub> [Nm]		J <sub>m</sub> [Kgm <sup>2</sup> ]	
	[kW] 400V 50Hz	[HP] 400V 50Hz	[kW] 460V 60Hz	[HP] 460V 60Hz	50Hz Min.	60Hz Min.	50Hz Min.	60Hz Min.			50Hz	60Hz	50Hz	60Hz	50Hz	60Hz		
S71C	0.09	0.12	0.11	0.14	100	120	600	720	1.0	1.0	28	28	0.47	0.55	1.4	1.4	0.00100	6.4
S80C	0.15	0.20	0.18	0.24	100	120	600	720	1.4	1.4	36	37	0.43	0.50	2.4	2.4	0.00280	11.0
S90S	0.18	0.24	0.22	0.29	100	120	600	720	1.4	1.4	37	38	0.51	0.59	2.9	2.9	0.00350	12.0
S90LB	0.25	0.34	0.30	0.40	100	120	600	720	1.6	1.6	39	40	0.58	0.67	4.0	4.0	0.00550	16.0
S100B	0.55	0.74	0.66	0.89	100	120	600	720	2.0	2.0	43	44	0.93	1.1	8.8	8.8	0.01000	22
S112A	0.75	1.01	0.90	1.2	100	120	600	720	2.4	2.4	44	45	1.0	1.2	11.9	11.9	0.01500	32







TRIFASE  
THREE-PHASE  
DREHSTROM

SA autoventilati / SA self-cooled / SA eigenbelüftete

Tipo Type Typ	FD Autofrenante in D.C. Brake motor in D.C. Gleichstrom-Bremsmotor				FA Autofrenante in A.C. Brake motor In A.C. Wechselstrom-Bremsmotor				FS Autofrenante in D.C. Brake motor in D.C. Gleichstrom-Bremsmotor				FP Autofrenante in D.C. Brake motor in D.C. Gleichstrom-Bremsmotor			
	CF	Z <sub>0</sub>	PB		CF	Z <sub>0</sub>	PB		CF	Z <sub>0</sub>	PB		CF	Z <sub>0</sub>	PB	
	[Nm]	[1/h]	[W]		[Nm]	[1/h]	[W]		[Nm]	[1/h]	[W]		[Nm]	[1/h]	[W]	
SA71C	5.0	16000	20	9.0	5.0	16000	18.0	9.0	4.0	16000	17.0	9.0	7.5	16000	11.5	7.8
SA80C	10.0	9000	25	13.5	10.0	9000	25	13.5	8.0	9000	34	13.5	15.0	9000	16.0	11.1
SA90S	16.0	13500	30	17.0	20	13500	30	17.0	8.0	13500	34	15.0	15.0	13500	16.0	12.6
SA90LB	16.0	8000	30	20	20	8000	30	20	8.0	8000	34	18.0	15.0	8000	16.0	16.1
SA100B	32	6300	40	28	40	6300	35	30	11.0	6300	40	25	30	6300	21	22
SA112A	60	3600	50	38	80	3600	35	38	11.0	3600	40	33	30	3600	21	30


Tipo Type Typ	FD Autofrenante in D.C. Brake motor in D.C. Gleichstrom-Bremsmotor				FA Autofrenante in A.C. Brake motor In A.C. Wechselstrom-Bremsmotor				FS Autofrenante in D.C. Brake motor in D.C. Gleichstrom-Bremsmotor				FP Autofrenante in D.C. Brake motor in D.C. Gleichstrom-Bremsmotor			
	CF	Z <sub>0</sub>	PB		CF	Z <sub>0</sub>	PB		CF	Z <sub>0</sub>	PB		CF	Z <sub>0</sub>	PB	
	[Nm]	[1/h]	[W]		[Nm]	[1/h]	[W]		[Nm]	[1/h]	[W]		[Nm]	[1/h]	[W]	
SA71C	5.0	24000	20	8.0	5.0	24000	18.0	8.0	4.0	24000	17.0	8.0	7.5	24000	11.5	6.9
SA80C	10.0	15000	25	14.0	10.0	15000	25	14.0	8.0	15000	34	14.0	15.0	15000	16.0	11.6
SA90S	16.0	15000	30	17.0	20	15000	30	17.0	8.0	15000	34	15.0	15.0	15000	16.0	12.6
SA90LB	16.0	13000	30	20	20	13000	30	20	8.0	13000	34	18.5	15.0	13000	16.0	16.6
SA100B	32	7500	40	28	40	7500	35	30	11.0	7500	40	25	30	7500	21	22
SA112A	60	6000	50	39	80	6000	35	39	11.0	6000	40	34	30	6000	21	31

Tipo Type Typ	FD Autofrenante in D.C. Brake motor in D.C. Gleichstrom-Bremsmotor				FA Autofrenante in A.C. Brake motor In A.C. Wechselstrom-Bremsmotor				FS Autofrenante in D.C. Brake motor in D.C. Gleichstrom-Bremsmotor				FP Autofrenante in D.C. Brake motor in D.C. Gleichstrom-Bremsmotor			
	CF	Z <sub>0</sub>	PB		CF	Z <sub>0</sub>	PB		CF	Z <sub>0</sub>	PB		CF	Z <sub>0</sub>	PB	
	[Nm]	[1/h]	[W]		[Nm]	[1/h]	[W]		[Nm]	[1/h]	[W]		[Nm]	[1/h]	[W]	
SA71C	5.0	27000	20	8.0	5.0	27000	18.0	8.0	4.0	27000	17.0	8.0	7,5	27000	11,5	6,75
SA80C	10.0	25500	25	14.0	10.0	25500	25	14.0	8.0	15000	34	14.0	15.0	15000	16.0	11,6
SA90S	16.0	18000	30	17.0	20	18000	30	17.0	8.0	18000	34	15.0	15.0	18000	16.0	12,6
SA90LB	16.0	14500	30	20	20	14500	30	20	8.0	14500	34	19.0	15.0	14500	16.0	16,6
SA100B	32	8500	40	29	40	8500	35	31	11.0	8500	40	26	30	8500	21	23
SA112A	60	6500	50	41	80	6500	35	41	11.0	6500	40	36	30	6500	21	33


TRIFASE  
THREE-PHASE  
DREHSTROM

S autoventilati / S self-cooled / S eigenbelüftete


4 P 1500 min<sup>-1</sup>

Tipo Type Typ	P <sub>n</sub>				n <sub>n</sub> [min <sup>-1</sup> ]				I <sub>n</sub> 400V [A]		I <sub>n</sub> 460V [A]		η %		cos φ		C <sub>n</sub> [Nm]		J <sub>m</sub> [Kgm <sup>2</sup> ]	
	[kW] 400V 50Hz	[HP] 400V 50Hz	[kW] 460V 60Hz	[HP] 460V 60Hz	50Hz Min.	60Hz Min.	50Hz Min.	60Hz Min.	50Hz	60Hz	50Hz	60Hz	50Hz	60Hz	50Hz	60Hz	50Hz	60Hz		
S71C	0.18	0.24	0.22	0.29	0	0	1200	1440	1.5	1.5	53	54	0.33	0.38	1.4	1.4	0.00090	7.4		
S80C	0.37	0.50	0.44	0.60	0	0	1200	1440	2.3	2.3	56	58	0.42	0.48	3.0	3.0	0.00200	10.5		
S90S	0.55	0.74	0.66	0.89	0	0	1200	1440	2.6	2.6	60	62	0.51	0.59	4.4	4.4	0.00330	12.0		
S90LB	0.75	1.0	0.90	1.21	0	0	1200	1440	3.2	3.2	62	63	0.55	0.64	6.0	6.0	0.00500	15.5		
S100B	1.1	1.5	1.3	1.8	0	0	1200	1440	4.3	4.3	62	64	0.59	0.69	8.8	8.8	0.00850	21		
S112A	1.5	2.0	1.8	2.4	0	0	1200	1440	7.2	7.2	64	66	0.47	0.55	11.9	11.9	0.01300	29		
S132S	2.2	3.0	2.6	3.5	0	0	1200	1440	8.0	8.0	65	67	0.61	0.71	17.5	17.5	0.02400	43		
S132M	3.0	4.0	3.6	4.8	0	0	1200	1440	11.0	11.0	66	68	0.60	0.70	24	24	0.03300	52		

6 P 1000 min<sup>-1</sup>





Tipo Type Typ	P <sub>n</sub>				n <sub>n</sub> [min <sup>-1</sup> ]				I <sub>n</sub> (400V) [A]		I <sub>n</sub> 460V [A]		η %		cos φ		C <sub>n</sub> [Nm]		J <sub>m</sub> [Kgm <sup>2</sup> ]	
	[kW] 400V 50Hz	[HP] 400V 50Hz	[kW] 460V 60Hz	[HP] 460V 60Hz	50Hz Min.	60Hz Min.	50Hz Min.	60Hz Min.	50Hz	60Hz	50Hz	60Hz	50Hz	60Hz	50Hz	60Hz	50Hz	60Hz		
S71C	0.15	0.20	0.18	0.24	0	0	800	960	1.4	1.4	48	49	0.32	0.38	1.8	1.8	0.00100	6.5		
S80C	0.37	0.50	0.44	0.60	0	0	800	960	2.8	2.8	55	57	0.35	0.40	4.4	4.4	0.00260	11.0		
S90S	0.45	0.60	0.54	0.72	0	0	800	960	3.0	3.0	58	59	0.38	0.44	5.4	5.4	0.00350	12.0		
S90LB	0.55	0.74	0.66	0.89	0	0	800	960	3.8	3.8	58	60	0.36	0.42	6.6	6.6	0.00500	16.0		
S100B	0.88	1.2	1.1	1.4	0	0	800	960	5.0	5.0	62	63	0.41	0.48	10.5	10.5	0.01000	21		
S112A	1.1	1.5	1.3	1.8	0	0	800	960	6.0	6.0	64	66	0.41	0.48	13.1	13.1	0.01500	30		
S132S	1.9	2.5	2.2	3.0	0	0	800	960	9.0	9.0	65	67	0.46	0.53	22	22	0.03000	43		
S132M	2.2	3.0	2.6	3.5	0	0	800	960	14.0	14.0	66	68	0.34	0.40	26	26	0.04000	52		





8 P 750 min<sup>-1</sup>





Tipo Type Typ	P <sub>n</sub>				n <sub>n</sub> [min <sup>-1</sup> ]				I <sub>n</sub> (400V) [A]		I <sub>n</sub> (460V) [A]		η %		cos φ		C <sub>n</sub> [Nm]		J <sub>m</sub> [Kgm <sup>2</sup> ]	
	[kW] 400V 50Hz	[HP] 400V 50Hz	[kW] 460V 60Hz	[HP] 460V 60Hz	50Hz Min.	60Hz Min.	50Hz Min.	60Hz Min.	50Hz	60Hz	50Hz	60Hz	50Hz	60Hz	50Hz	60Hz	50Hz	60Hz		
S71C	0.12	0.16	0.14	0.19	0	0	600	720	1.3	1.3	37	38	0.36	0.42	1.9	1.9	0.00100	6.4		
S80C	0.25	0.34	0.30	0.40	0	0	600	720	2.2	2.2	48	49	0.34	0.40	4.0	4.0	0.00280	11.0		
S90S	0.37	0.50	0.44	0.60	0	0	600	720	2.5	2.5	49	50	0.44	0.51	5.9	5.9	0.00350	12.0		
S90LB	0.45	0.60	0.54	0.72	0	0	600	720	3.3	3.3	52	54	0.38	0.44	7.2	7.2	0.00550	16.0		
S100B	0.75	1.0	0.9	1.2	0	0	600	720	4.2	4.2	57	59	0.45	0.53	11.9	11.9	0.01000	22		
S112A	0.88	1.2	1.1	1.4	0	0	600	720	6.3	6.3	58	60	0.35	0.40	14.0	14.0	0.01500	32		
S132S	1.5	2.0	1.8	2.4	0	0	600	720	9.0	9.0	58	60	0.41	0.48	24	24	0.03000	44		
S132M	1.9	2.5	2.2	3.0	0	0	600	720	12.0	12.0	61	63	0.37	0.43	29	29	0.04000	53		

TRIFASE  
THREE-PHASE  
DREHSTROM

SA autoventilati / SA self-cooled / SA eigenbelüftete

Tipo Type Typ	FD Autofrenante in D.C. Brake motor in D.C. Gleichstrom-Bremsmotor				FA Autofrenante in A.C. Brake motor In A.C. Wechselstrom-Bremsmotor				FS Autofrenante in D.C. Brake motor in D.C. Gleichstrom-Bremsmotor				FP Autofrenante in D.C. Brake motor in D.C. Gleichstrom-Bremsmotor			
	CF	Z <sub>0</sub>	PB		CF	Z <sub>0</sub>	PB		CF	Z <sub>0</sub>	PB		CF	Z <sub>0</sub>	PB	
	[Nm]	[1/h]	[W]		[Nm]	[1/h]	[W]		[Nm]	[1/h]	[W]		[Nm]	[1/h]	[W]	
SA71C	5.0	16000	20	9.0	5.0	16000	18.0	9.0	4.0	16000	17.0	9.0	7.5	16000	11.5	7.8
SA80C	10.0	9000	25	13.5	10.0	9000	25	13.5	8.0	9000	34	13.5	15.0	9000	16.0	11.1
SA90S	16.0	13500	30	17.0	20	13500	30	17.0	8.0	13500	34	15.0	15.0	13500	16.0	12.6
SA90LB	16.0	8000	30	20	20	8000	30	20	8.0	8000	34	18.0	15.0	8000	16.0	16.1
SA100B	32	6300	40	28	40	6300	35	30	11.0	6300	40	25	30	6300	21	22
SA112A	60	3600	50	38	80	3600	35	38	11.0	3600	40	33	30	3600	21	30
SA132S	80	1100	55	56	100	1100	45	57	17.0	1100	40	48	60	1100	28	44
SA132M	80	850	55	66	100	850	45	67	17.0	850	40	57	60	850	28	53

Tipo Type Typ	FD Autofrenante in D.C. Brake motor in D.C. Gleichstrom-Bremsmotor				FA Autofrenante in A.C. Brake motor In A.C. Wechselstrom-Bremsmotor				FS Autofrenante in D.C. Brake motor in D.C. Gleichstrom-Bremsmotor				FP Autofrenante in D.C. Brake motor in D.C. Gleichstrom-Bremsmotor			
	CF	Z <sub>0</sub>	PB		CF	Z <sub>0</sub>	PB		CF	Z <sub>0</sub>	PB		CF	Z <sub>0</sub>	PB	
	[Nm]	[1/h]	[W]		[Nm]	[1/h]	[W]		[Nm]	[1/h]	[W]		[Nm]	[1/h]	[W]	
SA71C	5.0	24000	20	8.0	5.0	24000	18.0	8.0	4.0	24000	17.0	8.0	7.5	24000	11.5	6.9
SA80C	10.0	15000	25	14.0	10.0	15000	25	14.0	8.0	15000	34	14.0	15.0	15000	16.0	11.6
SA90S	16.0	15000	30	17.0	20	15000	30	17.0	8.0	15000	34	15.0	15.0	15000	16.0	12.6
SA90LB	16.0	13000	30	20	20	13000	30	20	8.0	13000	34	18.5	15.0	13000	16.0	16.6
SA100B	32	7500	40	28	40	7500	35	30	11.0	7500	40	25	30	7500	21	22
SA112A	60	6000	50	39	80	6000	35	39	11.0	6000	40	34	30	6000	21	31
SA132S	80	1600	55	56	100	1600	45	57	17.0	1600	40	48	60	1600	28	44
SA132M	80	1350	55	65	100	1350	45	66	17.0	1350	40	57	60	1350	28	53

Tipo Type Typ	FD Autofrenante in D.C. Brake motor in D.C. Gleichstrom-Bremsmotor				FA Autofrenante in A.C. Brake motor In A.C. Wechselstrom-Bremsmotor				FS Autofrenante in D.C. Brake motor in D.C. Gleichstrom-Bremsmotor				FP Autofrenante in D.C. Brake motor in D.C. Gleichstrom-Bremsmotor			
	CF	Z <sub>0</sub>	PB		CF	Z <sub>0</sub>	PB		CF	Z <sub>0</sub>	PB		CF	Z <sub>0</sub>	PB	
	[Nm]	[1/h]	[W]		[Nm]	[1/h]	[W]		[Nm]	[1/h]	[W]		[Nm]	[1/h]	[W]	
SA71C	5.0	27000	20	8.0	5.0	27000	18.0	8.0	4.0	27000	17.0	8.0	7.5	27000	11.5	6.8
SA80C	10.0	25500	25	14.0	10.0	25500	25	14.0	8.0	15000	34	14.0	15.0	15000	16.0	11.6
SA90S	16.0	18000	30	17.0	20	18000	30	17.0	8.0	18000	34	15.0	15.0	18000	16.0	12.6
SA90LB	16.0	14500	30	20	20	14500	30	20	8.0	14500	34	19.0	15.0	14500	16.0	16.6
SA100B	32	8500	40	29	40	8500	35	31	11.0	8500	40	26	30	8500	21	23
SA112A	60	6500	50	41	80	6500	35	41	11.0	6500	40	36	30	6500	21	33
SA132S	80	1900	55	57	100	1900	45	58	17.0	1900	40	49	60	1900	28	45
SA132M	80	1900	55	66	100	1900	45	67	17.0	1900	40	58	60	1900	28	54

TRIFASE  
THREE-PHASE  
DREHSTROM

R

**2 P** 3000 min<sup>-1</sup>

Tipo Type Typ	Pn				n <sub>n</sub> <sup>-1</sup> [min] <sup>-1</sup>		In (400V) [A]	In (460V) [A]	η %		Cos φ		I <sub>a</sub> In		Ca Cn		C <sub>max</sub> Cn		Cn [Nm]		J <sub>m</sub> [Kgm] <sup>2</sup>	
	[kW] 400V 50Hz	[HP] 400V 50Hz	[kW] 460V 60Hz	[HP] 460V 60Hz	50Hz Min.	60Hz Min.	50Hz	60Hz	50Hz	60Hz	50Hz	60Hz	50Hz	60Hz	50Hz	60Hz	50Hz	60Hz	50Hz	60Hz		
	<b>R63B</b>	0.18	0.24	0.22	0.29	3000	3600	0.90	0.90	50	52	0.58	0.67	3.0	3.3	2.5	2.9	2.0	2.2	0.57		
<b>R63C</b>	0.25	0.34	0.30	0.40	3000	3600	1.1	1.1	51	53	0.64	0.75	3.0	3.3	2.5	2.9	2.0	2.2	0.80	0.80	0.00035	5.6
<b>R71B</b>	0.37	0.50	0.44	0.60	3000	3600	1.4	1.4	51	53	0.75	0.87	3.0	3.3	2.5	2.9	2.0	2.2	1.2	1.2	0.00046	6.2
<b>R71C</b>	0.55	0.74	0.66	0.89	3000	3600	2.0	2.0	51	53	0.78	0.91	3.0	3.3	2.5	2.9	2.0	2.2	1.8	1.8	0.00057	7.4
<b>R80B</b>	0.75	1.0	0.90	1.2	3000	3600	2.5	2.5	53	55	0.82	0.95	3.0	3.3	2.5	2.9	2.0	2.2	2.4	2.4	0.00097	9.8
<b>R80C</b>	1.1	1.5	1.3	2	3000	3600	3.5	3.5	54	56	0.84	0.98	3.0	3.3	2.5	2.9	2.0	2.2	3.5	3.5	0.00120	10.5
<b>R90S</b>	1.5	2.0	1.8	2	3000	3600	4.8	4.8	56	58	0.81	0.94	3.0	3.3	2.5	2.9	2.0	2.2	4.8	4.8	0.00230	13.5
<b>R90LB</b>	2.2	3.0	2.6	4	3000	3600	7.0	7.0	57	59	0.80	0.93	3.0	3.3	2.5	2.9	2.0	2.2	7.0	7.0	0.00230	13.5
<b>R100B</b>	3.0	4.0	3.6	5	3000	3600	9.0	9.0	59	61	0.82	0.95	3.0	3.3	2.5	2.9	2.0	2.2	9.6	9.6	0.00850	21
<b>R112B</b>	4.0	5.4	4.8	6	3000	3600	12.0	12.0	60	62	0.80	0.94	3.0	3.3	2.5	2.9	2.0	2.2	12.7	12.7	0.01200	32

**4 P** 1500 min<sup>-1</sup>





Tipo Type Typ	Pn				n <sub>n</sub> <sup>-1</sup> [min] <sup>-1</sup>		In (400V) [A]	In (460V) [A]	η %		Cos φ		I <sub>a</sub> In		Ca Cn		C <sub>max</sub> Cn		Cn [Nm]		J <sub>m</sub> [Kgm] <sup>2</sup>	
	[kW] 400V 50Hz	[HP] 400V 50Hz	[kW] 460V 60Hz	[HP] 460V 60Hz	50Hz Min.	60Hz Min.	50Hz	60Hz	50Hz	60Hz	50Hz	60Hz	50Hz	60Hz	50Hz	60Hz	50Hz	60Hz	50Hz	60Hz		
	<b>R63A</b>	0.12	0.16	0.14	0.19	1500	1800	0.60	0.60	50	52	0.58	0.67	2.7	3.0	2.3	2.6	1.7	1.9	0.76		
<b>R71B</b>	0.37	0.50	0.44	0.60	1500	1800	1.6	1.6	52	54	0.64	0.75	2.7	3.0	2.3	2.6	1.7	1.9	2.4	2.4	0.00090	7.4
<b>R80A</b>	0.55	0.74	0.66	0.89	1500	1800	2.2	2.2	53	55	0.68	0.79	2.7	3.0	2.3	2.6	1.7	1.9	3.5	3.5	0.00230	11.0
<b>R80B</b>	0.75	1.0	0.90	1.2	1500	1800	2.6	2.6	54	56	0.77	0.90	2.7	3.0	2.3	2.6	1.7	1.9	4.8	4.8	0.00230	11.0
<b>R90S</b>	1.1	1.5	1.3	1.8	1500	1800	4.0	4.0	55	57	0.72	0.84	2.7	3.0	2.3	2.6	1.7	1.9	7.0	7.0	0.00400	13.5
<b>R90L</b>	1.5	2.0	1.8	2.4	1500	1800	5.0	5.0	55	57	0.79	0.92	2.7	3.0	2.3	2.6	1.7	1.9	9.6	9.6	0.00500	15.5
<b>R100A</b>	2.2	3.0	2.6	3.5	1500	1800	7.0	7.0	57	59	0.80	0.93	2.7	3.0	2.3	2.6	1.7	1.9	14.0	14.0	0.01100	23
<b>R100B</b>	3.0	4.0	3.6	4.8	1500	1800	10.0	10.0	57	59	0.76	0.89	2.7	3.0	2.3	2.6	1.7	1.9	19.1	19.1	0.01100	23
<b>R112A</b>	4.0	5.4	4.8	6.4	1500	1800	12.8	12.8	58	60	0.78	0.91	2.7	3.0	2.3	2.6	1.7	1.9	25	25	0.01600	35
<b>R132S</b>	5.5	7.4	6.6	8.9	1500	1800	15.0	15.0	63	65	0.84	0.98	2.7	3.0	2.3	2.6	1.7	1.9	35	35	0.02400	52
<b>R132M</b>	7.5	10.1	9.0	12.1	1500	1800	18.0	18.0	73	75	0.82	0.96	2.7	3.0	2.3	2.6	1.7	1.9	48	48	0.03400	54
<b>R160M</b>	11.0	14.8	13.2	17.7	1500	1800	26	26	76	78	0.80	0.94	2.7	3.0	2.3	2.6	1.7	1.9	70	70	0.06200	68





**6 P** 1000 min<sup>-1</sup>





Tipo Type Typ	Pn				n <sub>n</sub> <sup>-1</sup> [min] <sup>-1</sup>		In (400V) [A]	In (460V) [A]	η %		Cos φ		I <sub>a</sub> In		Ca Cn		C <sub>max</sub> Cn		Cn [Nm]		J <sub>m</sub> [Kgm] <sup>2</sup>	
	[kW] 400V 50Hz	[HP] 400V 50Hz	[kW] 460V 60Hz	[HP] 460V 60Hz	50Hz Min.	60Hz Min.	50Hz	60Hz	50Hz	60Hz	50Hz	60Hz	50Hz	60Hz	50Hz	60Hz	50Hz	60Hz	50Hz	60Hz		
	<b>R71A</b>	0.18	0.24	0.22	0.29	1000	1200	1.20	1.20	46	47	0.47	0.55	2.5	2.8	2.0	2.3	1.5	1.7	1.72		
<b>R80A</b>	0.37	0.50	0.44	0.60	1000	1200	1.7	1.7	50	52	0.63	0.73	2.5	2.8	2.0	2.3	1.5	1.7	3.5	3.5	0.00260	11.0
<b>R80B</b>	0.55	0.74	0.66	0.89	1000	1200	2.0	2.0	52	54	0.76	0.89	2.5	2.8	2.0	2.3	1.5	1.7	5.3	5.3	0.00260	11.0
<b>R90S</b>	0.75	1.0	0.90	1.2	1000	1200	3.3	3.3	53	55	0.62	0.72	2.5	2.8	2.0	2.3	1.5	1.7	7.2	7.2	0.00350	12.0
<b>R90L</b>	1.1	1.5	1.3	1.8	1000	1200	4.1	4.1	53	55	0.73	0.85	2.5	2.8	2.0	2.3	1.5	1.7	10.5	10.5	0.00500	16.0
<b>R100A</b>	1.5	2.0	1.8	2.4	1000	1200	5.9	5.9	55	57	0.67	0.78	2.5	2.8	2.0	2.3	1.5	1.7	14.3	14.3	0.01100	23
<b>R100B</b>	1.9	2.5	2.2	3.0	1000	1200	7.8	7.8	55	57	0.62	0.73	2.5	2.8	2.0	2.3	1.5	1.7	17.7	17.7	0.01100	23
<b>R112A</b>	2.2	3.0	2.6	3.5	1000	1200	9.2	9.2	56	58	0.62	0.72	2.5	2.8	2.0	2.3	1.5	1.7	21	21	0.01800	37
<b>R132S</b>	3.0	4.0	3.6	4.8	1000	1200	12.0	12.0	59	61	0.61	0.71	2.5	2.8	2.0	2.3	1.5	1.7	29	29	0.03000	43
<b>R132M</b>	4.0	5.4	4.8	6.4	1000	1200	16.0	16.0	60	62	0.60	0.70	2.5	2.8	2.0	2.3	1.5	1.7	38	38	0.04200	55
<b>R160M</b>	7.5	10.1	9.0	12.1	1000	1200	24	24	64	66	0.71	0.82	2.5	2.8	2.0	2.3	1.5	1.7	72	72	0.10600	90

RA

TRIFASE  
THREE-PHASE  
DREHSTROM

Tipo Type Typ	FD Autofrenante in D.C. Brake motor in D.C. Gleichstrom-Bremsmotor				FA Autofrenante in A.C. Brake motor In A.C. Wechselstrom-Bremsmotor				FS Autofrenante in D.C. Brake motor in D.C. Gleichstrom-Bremsmotor				FP Autofrenante in D.C. Brake motor in D.C. Gleichstrom-Bremsmotor			
	CF	Z <sub>0</sub>	PB		CF	Z <sub>0</sub>	PB		CF	Z <sub>0</sub>	PB		CF	Z <sub>0</sub>	PB	
	[Nm]	[1/h]	[W]		[Nm]	[1/h]	[W]		[Nm]	[1/h]	[W]		[Nm]	[1/h]	[W]	
RA63B	5.0	6750	20	6.0	5.0	6750	18.0	6.0	4.0	6750	17.0	6.0	7.5	6750	11.5	4.7
RA63C	5.0	5400	20	7.0	5.0	5400	18.0	7.0	4.0	5400	17.0	7.0	7.5	5400	11.5	6.0
RA71B	5.0	5400	20	8.0	5.0	5400	18.0	8.0	4.0	5400	17.0	8.0	7.5	5400	11.5	6.6
RA71C	5.0	5500	20	9.0	5.0	5500	18.0	9.0	4.0	5500	17.0	9.0	7.5	5500	11.5	7.8
RA80B	10.0	5400	25	12.0	10.0	5400	25	12.0	8.0	5400	34	12.0	15.0	5400	16.0	10.4
RA80C	10.0	5100	25	13.0	10.0	5100	25	13.0	8.0	5100	34	13.0	15.0	5100	16.0	11.1
RA90S	16.0	4000	30	18.0	20	4000	30	18.0	8.0	4000	34	15.0	15.0	4000	16.0	14.1
RA90LB	16.0	4000	30	18.0	20	4000	30	18.0	8.0	4000	34	15.0	15.0	4000	16.0	14.1
RA100B	32	2400	40	28	40	2400	35	30	11.0	2400	40	25	30	2400	21	22
RA112B	60	1400	50	41	80	1400	35	41	11.0	1400	40	36	30	1400	21	33

Tipo Type Typ	FD Autofrenante in D.C. Brake motor in D.C. Gleichstrom-Bremsmotor				FA Autofrenante in A.C. Brake motor In A.C. Wechselstrom-Bremsmotor				FS Autofrenante in D.C. Brake motor in D.C. Gleichstrom-Bremsmotor				FP Autofrenante in D.C. Brake motor in D.C. Gleichstrom-Bremsmotor			
	CF	Z <sub>0</sub>	PB		CF	Z <sub>0</sub>	PB		CF	Z <sub>0</sub>	PB		CF	Z <sub>0</sub>	PB	
	[Nm]	[1/h]	[W]		[Nm]	[1/h]	[W]		[Nm]	[1/h]	[W]		[Nm]	[1/h]	[W]	
RA63A	5.0	10500	20	7.0	5.0	10500	18.0	7.0	4.0	10500	17.0	6.0	7.5	10500	11.5	4.7
RA71B	5.0	16000	20	9.0	5.0	16000	18.0	9.0	4.0	16000	17.0	9.0	7.5	16000	11.5	7.8
RA80A	10.0	9000	25	14.0	10.0	9000	25	14.0	8.0	9000	34	14.0	15.0	9000	16.0	11.6
RA80B	10.0	9000	25	14.0	10.0	9000	25	14.0	8.0	9000	34	14.0	15.0	9000	16.0	11.6
RA90S	16.0	11000	30	18.0	20	11000	30	18.0	8.0	11000	34	16.0	15.0	11000	16.0	14.1
RA90L	16.0	8000	30	20	20	8000	30	20	8.0	8000	34	18.0	15.0	8000	16.0	16.1
RA100A	32	6000	40	30	40	6000	35	32	11.0	6000	40	27	30	6000	21	24
RA100B	32	6000	40	30	40	6000	35	32	11.0	6000	40	27	30	6000	21	24
RA112A	60	3400	50	44	80	3400	35	44	11.0	3400	40	39	30	3400	21	36
RA132S	80	1100	55	56	100	1100	45	57	17.0	1100	40	48	60	1100	28	44
RA132M	80	800	55	68	100	800	45	69	17	800	40	59	60	800	28	55
RA160M	150	750	85	87	150	750	47	85	25	750	45	75	120	750	38	70

Tipo Type Typ	FD Autofrenante in D.C. Brake motor in D.C. Gleichstrom-Bremsmotor				FA Autofrenante in A.C. Brake motor In A.C. Wechselstrom-Bremsmotor				FS Autofrenante in D.C. Brake motor in D.C. Gleichstrom-Bremsmotor				FP Autofrenante in D.C. Brake motor in D.C. Gleichstrom-Bremsmotor			
	CF	Z <sub>0</sub>	PB		CF	Z <sub>0</sub>	PB		CF	Z <sub>0</sub>	PB		CF	Z <sub>0</sub>	PB	
	[Nm]	[1/h]	[W]		[Nm]	[1/h]	[W]		[Nm]	[1/h]	[W]		[Nm]	[1/h]	[W]	
RA71A	5.0	24000	20	8.0	5.0	24000	18.0	8.0	4.0	24000	17.0	8.0	7.5	24000	11.5	6.9
RA80A	10.0	16000	25	13.0	10.0	16000	25	13.0	8.0	16000	34.0	13.0	15.0	16000	16.0	11.1
RA80B	10.0	16000	25	13.0	10.0	16000	25	13.0	8.0	16000	34	13.0	15.0	16000	16.0	11.1
RA90S	16.0	15000	30	17.0	20	15000	30	17.0	8.0	15000	34	15.0	15.0	15000	16.0	12.6
RA90L	16.0	13000	30	19.5	20	13000	30	19.5	8.0	13000	34	18.5	15.0	13000	16.0	16.6
RA100A	32	7000	40	30	40	7000	35	32	11.0	7000	40	27	30	7000	21	24
RA100B	32	7000	40	30	40	7000	35	32	11.0	7000	40	27	30	7000	21	24
RA112A	60	5500	50	46	80	5500	35	46	11.0	5500	40	41	30	5500	21	38
RA132S	80	1600	55	56	100	1600	45	57	17.0	1600	40	48	60	1600	28	44
RA132M	80	1100	55	68	100	1100	45	69	17.0	1100	40	60	60	1100	28	56
RA160M	150	850	85	109	150	850	47	107	25	850	45	95	120	850	38	92

MONOFASE  
SINGLE-PHASE  
EINPHASEN

M - MD - MC - MR - ME

2 P 3000 min<sup>-1</sup>

Alta coppia di spunto/ High starting torque  
Hohes Anlaufmoment ME-MR-MC

Tipo Type Typ	Pn		n <sub>n</sub> [min <sup>-1</sup> ]	In (230 V) [A]	η %	Cos φ	I <sub>a</sub> In	Ca Cn	Cn Nm	C <sub>VF</sub> [μF]	J <sub>m</sub> [Kgm <sup>2</sup> ]		Ca Cn	I <sub>a</sub> In	C <sub>max</sub> Cn	S <sub>c</sub>	
	[kW]	[HP]														ME	MR-MC
M50B	0.08	0.10	2730	0.70	46	0.86	2.3	0.60	0.27	8.0	0.00010	2.1	2.6	3.5	2.3	10.0	—
M56A	0.08	0.10	2740	0.80	52	0.88	2.3	0.60	0.20	10.0	0.00012	2.7	2.6	3.3	2.4	10.0	—
M56B	0.12	0.16	2760	1.2	52	0.88	2.6	0.60	0.35	14.0	0.00015	3.3	2.5	3.2	2.4	10.0	—
M63B	0.18	0.25	2780	1.5	54	0.90	2.9	0.68	0.62	10.0	0.00030	4.2	2.7	3.7	2.6	10.0	63-80
M63C	0.25	0.35	2780	2.0	54	0.92	2.9	0.68	0.80	10.0	0.00035	4.4	2.6	3.6	2.5	10.0	63-80
M71B	0.37	0.50	2800	3.6	58	0.94	3.1	0.70	1.3	16.0	0.00046	6.0	3.0	4.0	3.0	20	63-80
M71C	0.55	0.75	2800	4.5	60	0.94	3.1	0.74	1.9	20	0.00057	6.3	2.6	3.8	2.6	20	63-80
M80B	0.75	1.0	2830	6.0	62	0.92	3.2	0.76	2.5	25	0.00097	10.7	2.8	4.0	3.0	30	63-80
M80C	1.1	1.5	2840	9.5	64	0.90	3.2	0.78	3.5	30	0.00120	11.3	2.6	3.8	2.8	30	63-80
M80D	1.5	2.0	2700	10.3	66	0.92	3.3	0.79	3.7	40	0.00130	12.0	2.5	3.7	2.7	30	63-80
M90S	1.5	2.0	2860	11.5	68	0.92	3.3	0.80	5.2	40	0.00150	13.2	2.4	3.5	2.9	40	100-130
M90L	1.8	2.5	2860	13.0	70	0.90	3.2	0.82	6.1	50	0.00230	13.7	2.3	3.4	2.8	40	100-130
M90LB	2.2	3.0	2700	14.0	72	0.99	3.2	0.72	7.7	50	0.00280	16.0	2.0	4.0	2.4	40	100-130
M100B	2.2	3.0	2860	15.0	78	0.95	3.5	0.83	7.4	60	0.00530	22	2.1	4.4	2.7	50	100-130
M100BL	3.0	4.0	2800	17.5	77	0.99	3.6	0.50	10.4	60	0.00530	24	2.0	4.5	2.3	50	100-130

4 P 1500 min<sup>-1</sup>

Alta coppia di spunto/ High starting torque  
Hohes Anlaufmoment ME-MR-MC

Tipo Type Typ	Pn		n <sub>n</sub> [min <sup>-1</sup> ]	In (230 V) [A]	η %	Cos φ	I <sub>a</sub> In	Ca Cn	Cn Nm	C <sub>VF</sub> [μF]	J <sub>m</sub> [Kgm <sup>2</sup> ]		Ca Cn	I <sub>a</sub> In	C <sub>max</sub> Cn	S <sub>c</sub>	
	[kW]	[HP]														ME	MR-MC
M50B	0.06	0.08	1340	0.70	52	0.86	2.6	0.68	0.40	5.0	0.00010	2.5	1.3	2.0	2.0	10.0	—
M56B	0.09	0.12	1340	0.90	54	0.90	2.8	0.76	0.60	6.3	0.00015	3.3	1.4	2.1	2.0	10.0	—
M56C	0.11	0.15	1360	1.0	54	0.88	2.8	0.78	0.72	8.0	0.00020	3.4	1.6	2.3	2.1	10.0	—
M63B	0.12	0.16	1360	1.3	55	0.90	2.8	0.80	0.80	8.0	0.00040	4.3	1.8	2.3	2.0	10.0	63-80
M63C	0.18	0.25	1360	1.6	57	0.92	2.8	0.80	1.28	10.0	0.00040	4.8	1.9	2.4	2.0	10.0	63-80
M63D	0.22	0.30	1350	1.8	57	0.94	3.0	0.80	1.6	10.0	0.00050	5.2	1.9	2.5	2.0	10	63-80
M71B	0.25	0.35	1380	2.4	58	0.94	3.0	0.83	1.6	13	0.00080	6.8	2.0	2.5	2.2	20	63-80
M71C	0.37	0.5	1380	3.2	59	0.94	3.2	0.85	2.3	13	0.00090	7.8	2.4	2.3	2.1	20	63-80
M80A	0.6	0.8	1400	4.8	60	0.92	3.3	0.82	3.8	20	0.00140	10.0	2.2	2.7	2.2	30	63-80
M80B	0.8	1.0	1420	5.6	62	0.90	3.2	0.79	5.2	25	0.00170	11.4	2.4	2.8	2.1	30	63-80
M80C	0.9	1.2	1420	7.5	62	0.92	3.4	0.80	6.7	30	0.00230	11.0	2.5	3.0	2.0	30	63-80
M90S	1.1	1.5	1420	9.5	64	0.96	3.4	0.81	7.6	30	0.00330	13.8	2.7	3.1	2.3	40	63-80
M90L	1.5	2.0	1420	10.5	64	0.94	3.5	0.84	10.2	40	0.00400	14.5	2.9	3.8	2.2	40	100-130
M90LB	1.8	2.5	1420	12.5	66	0.94	3.6	0.85	12.0	50	0.00500	16.0	2.6	3.9	2.0	40	100-130
M100BL	2.2	3.0	1430	14.5	70	0.96	3.8	0.83	16.0	50	0.00850	23	2.4	4.0	2.6	50	100-130

6 P 1000 min<sup>-1</sup>

Alta coppia di spunto/ High starting torque  
Hohes Anlaufmoment ME-MR-MC

Tipo Type Typ	Pn		n <sub>n</sub> [min <sup>-1</sup> ]	In (230 V) [A]	η %	Cos φ	I <sub>a</sub> In	Ca Cn	Cn Nm	C <sub>VF</sub> [μF]	J <sub>m</sub> [Kgm <sup>2</sup> ]		Ca Cn	I <sub>a</sub> In	C <sub>max</sub> Cn	S <sub>c</sub>	
	[kW]	[HP]														ME	MR-MC
M56B	0.03	0.05	860	0.70	46	0.84	2.1	0.65	0.50	8.0	0.00020	3.3	1.2	2.0	1.7	10.0	—
M63B	0.09	0.12	880	1.20	48	0.86	2.4	0.68	0.85	12.5	0.00025	4.3	1.3	2.0	1.8	10.0	—
M63C	0.12	0.16	880	1.4	50	0.88	2.5	0.70	1.1	12.5	0.00040	4.6	1.6	2.2	1.9	10.0	63-80
M71B	0.18	0.25	900	2.0	54	0.88	2.6	0.71	1.6	14.0	0.00080	6.7	1.8	2.3	2.0	20	63-80
M71C	0.25	0.35	900	2.6	56	0.86	2.8	0.73	2.6	16.0	0.00010	7.6	1.9	2.5	2.1	20	63-80
M80B	0.37	0.50	900	3.5	63	0.90	3.0	0.75	3.8	16.0	0.00250	9.2	1.8	2.8	2.2	30	63-80
M80C	0.45	0.60	910	4.0	64	0.90	3.2	0.78	4.9	16	0.00260	11.0	1.9	3.0	2.0	30	63-80
M90L	0.55	0.75	920	4.5	72	0.92	3.4	0.78	5.8	25	0.00450	14.0	1.7	3.2	2.3	40	63-80
M90LB	0.75	1.0	920	6.0	74	0.90	3.5	0.80	7.9	30	0.00500	16.0	1.8	3.5	2.3	40	63-80
M100B	1.1	1.5	920	7.2	76	0.90	3.8	0.82	11.3	40	0.00900	22	2.0	4.0	2.4	50	63-80
M100BL	1.5	2.0	930	10.0	78	0.92	4.0	0.80	15.4	50	0.00950	24	2.0	4.5	2.3	50	63-80




2/4 P 3000/1500 min<sup>-1</sup> V 230/50 Hz




Alta coppia di spunto/ High starting torque Hohes  
Anlaufmoment ME-MR-MC




Tipo Type Typ	Pn		n <sub>n</sub> % [min <sup>-1</sup> ]	In (230 V) [A]	I <sub>a</sub> In	Ca Cn	Cn Nm	C <sub>VF</sub> [μF]		Ca Cn	I <sub>a</sub> In	C <sub>max</sub> Cn	S <sub>c</sub>	
	[kW]	[HP]											ME	MR-MC
M71C	0.37/0.25	0.5/0.35	2800/1400	3.9/2.4	2.8/3.2	0.7/0.6	1.2/1.7	16/10	7.5	1.7/2.0	3.0/2.0	2.0/2.0	20	63-80
M80C	0.75/0.55	1.0/0.75	2790/1410	6/5	3.0/3.4	0.8/0.7	2.6/3.7	25/16	11	2.0/2.0	3.5/2.5	2.1/2.3	30	63-80
M90S	1.0/0.70	1.4/1.0	2850/1420	8/6	2.8/3.2	0.8/0.8	3.4/4.7	30	13	2.1/2.0	4.0/3.0	2.4/2.6	40	63-80
M90LB	1.5/1.1	2.0/1.5	2830/1400	11/9	3.0/3.0	0.7/0.7	5.0/7.5	35	16	2.2/2.3	4.0/3.5	2.0/2.1	40	63-80
M100B	1.8/1.5	2.5/2.0	2840/1410	13/11	3.3/3.2	0.6/0.6	6/10	50	22	2.3/2.5	5.5/4.0	2.5/2.7	50	100-130




MONOFASE  
SINGLE-PHASE  
EINPHASEN

MA - MDA - MRA - MEA

Tipo Type Typ	FD Autofrenante in D.C. Brake motor in D.C. Gleichstrom-Bremsmotor				FS Autofrenante in D.C. Brake motor in D.C. Gleichstrom-Bremsmotor				FP Autofrenante in D.C. Brake motor in D.C. Gleichstrom-Bremsmotor			
	CF	Z <sub>0</sub>	PB		CF	Z <sub>0</sub>	PB		CF	Z <sub>0</sub>	PB	
	[Nm]	[1/h]	[W]		[Nm]	[1/h]	[W]		[Nm]	[1/h]	[W]	
MA50B	—	—	—	—	—	—	—	—	—	—	—	—
MA56A	1.0	9700	12	4.0	—	—	—	—	—	—	—	—
MA56B	1.0	8900	12	5.0	—	—	—	—	—	—	—	—
MA63B	5.0	6750	20	6.0	4.0	6750	17.0	6.0	7.5	6750	11.5	4.6
MA63C	5.0	5400	20	6.0	4.0	5400	17.0	6.0	7.5	5400	11.5	4.8
MA71B	5.0	5400	20	8.0	4.0	5400	17.0	7.0	7.5	5400	11.5	6.4
MA71C	5.0	5300	20	8.0	4.0	5300	17.0	8.0	7.5	5300	11.5	6.7
MA80B	10.0	5300	25	13.0	8.0	5300	34	13.0	15.0	5300	16.0	11.3
MA80C	10.0	5100	25	14.0	8.0	5100	34	14.0	15.0	5100	16.0	11.9
MA80D	10.0	4900	25	15.0	8.0	4900	34	15.0	15.0	4900	16.0	13.0
MA90S	16.0	4000	30	18.0	8.0	4000	34	16.0	15.0	4000	16.0	14.0
MA90L	16.0	4000	30	18.0	8.0	4000	34	16.0	15.0	4000	16.0	14.3
MA90LB	16.0	3800	30	21	8.0	3800	34	18.0	15.0	3800	16.0	16.6
MA100B	32	2500	40	29	11.0	2500	40	26	30	2500	21	23
MA100BL	32	2500	40	31	11.0	2500	40	28	30	2500	21	25

Tipo Type Typ	FD Autofrenante in D.C. Brake motor in D.C. Gleichstrom-Bremsmotor				FS Autofrenante in D.C. Brake motor in D.C. Gleichstrom-Bremsmotor				FP Autofrenante in D.C. Brake motor in D.C. Gleichstrom-Bremsmotor			
	CF	Z <sub>0</sub>	PB		CF	Z <sub>0</sub>	PB		CF	Z <sub>0</sub>	PB	
	[Nm]	[1/h]	[W]		[Nm]	[1/h]	[W]		[Nm]	[1/h]	[W]	
MA50B	—	—	—	—	—	—	—	—	—	—	—	—
MA56B	1.0	12500	12.0	5.0	—	—	—	—	—	—	—	—
MA56C	1.0	12500	12.0	5.0	—	—	—	—	—	—	—	—
MA63B	5.0	10500	20	6.0	4.0	10500	17.0	6.0	7.5	10500	11.5	4.7
MA63C	5.0	10500	20	6.0	4.0	10500	17.0	6.0	7.5	10500	11.5	5.2
MA63D	5.0	8400	20	6.4	4.0	8400	17.0	6.4	7.5	8400	11.5	5.6
MA71B	5.0	17000	20	9.0	4.0	17000	17.0	8.0	7.5	17000	11.5	7.2
MA71C	5.0	16000	20	11.0	4.0	16000	17.0	9.0	7.5	16000	11.5	8.2
MA80A	10.0	9000	25	13.0	8.0	9000	34	13.0	15.0	9000	16.0	10.6
MA80B	10.0	9000	25	14.0	8.0	9000	34	14.0	15.0	9000	16.0	12.0
MA80C	10.0	9000	25	13.2	8.0	9000	34	13.2	15.0	9000	16.0	11.6
MA90S	16.0	13500	30	18.0	8.0	13500	34	16.0	15.0	13500	16.0	14.4
MA90L	16.0	11000	30	19.0	8.0	11000	34	17.0	15.0	11000	16.0	15.1
MA90LB	16.0	8000	30	20	8.0	8000	34	18.0	15.0	8000	16.0	16.4
MA100BL	32	6000	40	30	11.0	6000	40	28	30.0	6000	21	24

Tipo Type Typ	FD Autofrenante in D.C. Brake motor in D.C. Gleichstrom-Bremsmotor				FS Autofrenante in D.C. Brake motor in D.C. Gleichstrom-Bremsmotor				FP Autofrenante in D.C. Brake motor in D.C. Gleichstrom-Bremsmotor			
	CF	Z <sub>0</sub>	PB		CF	Z <sub>0</sub>	PB		CF	Z <sub>0</sub>	PB	
	[Nm]	[1/h]	[W]		[Nm]	[1/h]	[W]		[Nm]	[1/h]	[W]	
MA56B	1.0	21500	12.0	5.0	—	—	—	—	—	—	—	—
MA63B	5.0	18000	20	6.0	4.0	18000	17.0	6.0	7.5	18000	11.5	4.7
MA63C	5.0	18000	20	6.0	4.0	18000	17.0	6.0	7.5	18000	11.5	5.0
MA71B	5.0	25000	20	9.0	4.0	25000	17.0	8.0	7.5	25000	11.5	7.1
MA71C	5.0	24000	20	9.0	4.0	24000	17.0	9.0	7.5	24000	11.5	8.0
MA80B	10.0	16000	25	11.0	8.0	16000	34	12.0	15.0	16000	16.0	9.8
MA80C	10.0	15000	25	14.0	8.0	15000	34	13.0	15.0	15000	16.0	11.6
MA90L	16.0	13500	30	19.0	8.0	13500	34	17.0	15.0	13500	16.0	14.6
MA90LB	16.0	13000	30	24	8.0	13000	34	19.0	15.0	13000	16.0	16.6
MA100B	32	7000	40	29	11.0	7000	40	27	30	7000	21	23
MA100BL	32	7000	40	31	11.0	7000	40	29	30	7000	21	25

Tipo Type Typ	FD Autofrenante in D.C. Brake motor in D.C. Gleichstrom-Bremsmotor				FS Autofrenante in D.C. Brake motor in D.C. Gleichstrom-Bremsmotor				FP Autofrenante in D.C. Brake motor in D.C. Gleichstrom-Bremsmotor			
	CF	Z <sub>0</sub>	PB		CF	Z <sub>0</sub>	PB		CF	Z <sub>0</sub>	PB	
	[Nm]	[1/h]	[W]		[Nm]	[1/h]	[W]		[Nm]	[1/h]	[W]	
MA71C	5.0	5300	20.0	9.0	4.00	5300	17.0	9.0	7.5	5300	11.5	7.9
MA80C	10.0	5100	25	14.0	8.0	5100	34	14.0	15.0	5100	16.0	11.6
MA90S	16.0	4000	30	18.0	8.0	4000	34	15.0	15.0	4000	16.0	13.6
MA90LB	16.0	3800	30	21	8.0	3800	34	18.0	15.0	3800	16.0	16.6
MA100B	32.0	2500	40	29	11.0	2500	40	26	30	2500	21	23

MF

MONOFASE  
SINGLE-PHASE  
EINPHASEN

2 P 3000 min<sup>-1</sup>

Tipo Type Typ	P <sub>n</sub>		n <sub>n</sub> [min <sup>-1</sup> ]	I <sub>n</sub> [A]		η %	Cos φ	I <sub>a</sub> I <sub>n</sub>	C <sub>a</sub> C <sub>n</sub>	C <sub>n</sub> [Nm]	C <sub>VF</sub> [ηF]	J <sub>m</sub> [Kgm <sup>2</sup> ]
	[kW]	[HP]		230V	115V							
MF63A	0.12	0.16	2760	1.14	2.28	52	0.88	2.6	0.6	0.42	16	0.00030
MF63B	0.18	0.25	2780	1.61	3.22	54	0.90	2.9	0.5	0.62	20	0.00030
MF63C	0.25	0.35	2780	2.19	4.38	54	0.92	2.9	0.6	0.86	25	0.00035
MF71B	0.37	0.50	2800	2.95	5.90	58	0.94	3.1	0.7	1.26	25	0.00046
MF71C	0.55	0.75	2800	4.24	8.48	60	0.94	3.1	0.6	1.88	25	0.00057
MF80B	0.75	1.0	2830	5.72	11.43	62	0.92	3.2	0.6	2.53	70	0.00097
MF80C	1.1	1.5	2840	8.30	16.61	64	0.90	3.2	0.6	3.70	70	0.00120
MF80D	1.5	2.0	2700	10.74	21.48	66	0.92	3.3	0.6	5.31	80	0.00130
MF90S	1.5	2.0	2860	10.42	20.85	68	0.92	3.3	0.5	5.01	80	0.00150
MF90L	1.8	2.5	2860	12.42	24.84	70	0.90	3.2	0.5	6.01	90	0.00230
MF90LB	2.2	3.0	2700	13.42	26.84	72	0.99	3.2	0.5	7.78	90	0.00280
MF100B	2.2	3.0	2860	12.91	25.82	78	0.95	3.5	0.4	7.35	100	0.00530
MF100BL	2.2	3.0	2800	12.55	25.10	77	0.99	3.6	0.35	7.51	100	0.00530

4 P 1500 min<sup>-1</sup>

Tipo Type Typ	P <sub>n</sub>		n <sub>n</sub> [min <sup>-1</sup> ]	I <sub>n</sub> [A]		η %	Cos φ	I <sub>a</sub> I <sub>n</sub>	C <sub>a</sub> C <sub>n</sub>	C <sub>n</sub> [Nm]	C <sub>VF</sub> [ηF]	J <sub>m</sub> [Kgm <sup>2</sup> ]
	[kW]	[HP]		230V	115V							
MF63B	0.12	0.16	1360	1.05	2.11	55	0.90	2.8	0.8	0.84	12.5	0.00040
MF63C	0.18	0.25	1360	1.49	2.98	57	0.92	2.8	0.7	1.26	12.5	0.00040
MF71B	0.25	0.35	1380	1.99	3.99	58	0.94	3.0	0.6	1.73	30	0.00080
MF71C	0.37	0.5	1380	2.90	5.80	59	0.94	3.2	0.6	2.56	30	0.00090
MF80A	0.55	0.75	1400	4.33	8.66	60	0.92	3.3	0.7	3.75	50	0.00140
MF80B	0.75	1.0	1420	5.84	11.69	62	0.90	3.2	0.6	5.05	60	0.00170
MF80C	0.88	1.2	1420	6.71	13.42	62	0.92	3.4	0.6	5.92	60	0.00230
MF90S	1.10	1.5	1420	7.78	15.57	64	0.96	3.4	0.5	7.40	80	0.00330
MF90L	1.50	2.0	1420	10.84	21.68	64	0.94	3.5	0.5	10.09	90	0.00400
MF90LB	1.80	2.5	1420	12.61	25.23	66	0.94	3.6	0.4	12.11	100	0.00500
MF100BL	2.20	3.0	1430	14.23	28.47	70	0.96	3.8	0.4	14.70	100	0.00850




6 P 1000 min<sup>-1</sup>




Tipo Type Typ	P <sub>n</sub>		n <sub>n</sub> [min <sup>-1</sup> ]	I <sub>n</sub> [A]		η %	Cos φ	I <sub>a</sub> I <sub>n</sub>	C <sub>a</sub> C <sub>n</sub>	C <sub>n</sub> [Nm]	C <sub>VF</sub> [ηF]	J <sub>m</sub> [Kgm <sup>2</sup> ]
	[kW]	[HP]		230V	115V							
MF71B	0.18	0.25	900	1.65	3.29	54	0.88	2.6	0.5	1.91	30	0.00080
MF80A	0.25	0.35	900	2.08	4.16	58	0.90	2.8	0.5	2.65	40	0.00140
MF80B	0.37	0.50	900	2.84	5.67	63	0.90	3.0	0.5	3.93	50	0.00250
MF90L	0.55	0.75	920	3.61	7.22	72	0.92	3.4	0.5	5.71	70	0.00450
MF90LB	0.75	1.0	920	4.90	9.79	74	0.90	3.5	0.4	7.79	80	0.00500
MF100B	1.1	1.5	920	6.99	13.98	76	0.90	3.8	0.5	11.42	100	0.00900
MF100BL	1.5	2.0	930	9.09	18.18	78	0.92	4.0	0.4	15.41	120	0.00950






MONOFASE  
SINGLE-PHASE  
EINPHASEN

MFA

Tipo Type Typ	FD Autofrenante in D.C. Brake motor in D.C. Gleichstrom-Bremsmotor				FS Autofrenante in D.C. Brake motor in D.C. Gleichstrom-Bremsmotor				FP Autofrenante in D.C. Brake motor in D.C. Gleichstrom-Bremsmotor			
	CF	Z <sub>0</sub>	PB		CF	Z <sub>0</sub>	PB		CF	Z <sub>0</sub>	PB	
	[Nm]	[1/h]	[W]		[Nm]	[1/h]	[W]		[Nm]	[1/h]	[W]	
MFA63A	5	6750	20	6.0	4	6750	17	6.0	7.5	6750	11.5	4.6
MFA63B	5	6750	20	6.0	4	6750	17	6.0	7.5	6750	11.5	4.6
MFA63C	5	5400	20	6.0	4	5400	17	6.0	7.5	5400	11.5	4.8
MFA71B	5	5400	20	8.0	4	5400	17	7.0	7.5	5400	11.5	6.4
MFA71C	5	5300	20	8.0	4	5300	17	8.0	7.5	5300	11.5	6.7
MFA80B	10	5300	25	13.0	8	5300	34	13.0	15	5300	16	11.3
MFA80C	10	5100	25	14.0	8	5100	34	14.0	15	5100	16	11.9
MFA80D	10	4900	25	15.0	8	4900	34	15.0	15	4900	16	13.0
MFA90S	16	4000	30	18.0	8	4000	34	16.0	15	4000	16	13.8
MFA90L	16	4000	30	18.0	8	4000	34	16.0	15	4000	16	14.3
MFA90LB	16	3800	30	21.0	8	3800	34	18.0	15	3800	16	16.6
MFA100B	32	2500	40	29.0	11	2500	40	26.0	30	2500	21	23.1
MFA100BL	32	2500	40	31.0	11	2500	40	28.0	30	2500	21	24.9

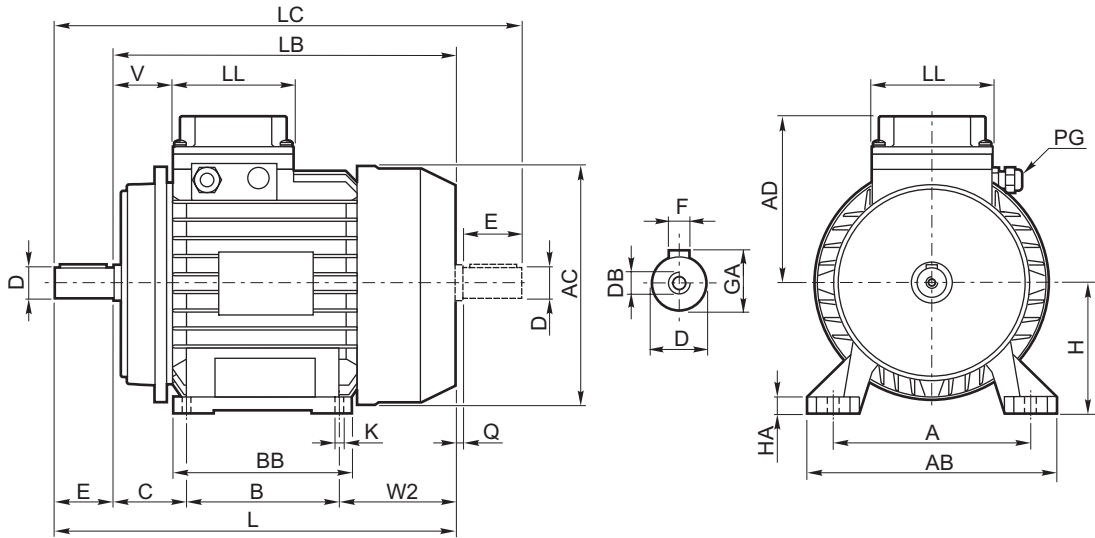
Tipo Type Typ	FD Autofrenante in D.C. Brake motor in D.C. Gleichstrom-Bremsmotor				FS Autofrenante in D.C. Brake motor in D.C. Gleichstrom-Bremsmotor				FP Autofrenante in D.C. Brake motor in D.C. Gleichstrom-Bremsmotor			
	CF	Z <sub>0</sub>	PB		CF	Z <sub>0</sub>	PB		CF	Z <sub>0</sub>	PB	
	[Nm]	-	[W]		[Nm]	[1/h]	[W]		[Nm]	[1/h]	[W]	
MFA63B	5	10500	20	6.0	4	10500	17	6.0	7.5	10500	11.5	4.7
MFA63C	5	10500	20	6.0	4	10500	17	6.0	7.5	10500	11.5	5.2
MFA71B	5	17000	20	9.0	4	17000	17	8.0	7.5	17000	11.5	7.2
MFA71C	5	16000	20	11.0	4	16000	17	9.0	7.5	16000	11.5	8.2
MFA80A	10	9000	25	13.0	8	9000	34	13.0	15	9000	16	10.6
MFA80B	10	9000	25	14.0	8	9000	34	14.0	15	9000	16	12.0
MFA80C	10	9000	25	13.2	8	9000	34	13.2	15	9000	16	11.6
MFA90S	16	13500	30	18.0	8	13500	34	16.0	15	13500	16	14.4
MFA90L	16	11000	30	19.0	8	11000	34	17.0	15	11000	16	15.1
MFA90LB	32	8000	30	20.0	8	8000	34	18.0	15	8000	16	16.4
MFA100BL	32	6000	40	29.5	11	6000	40	27.5	30	6000	21	23.9

Tipo Type Typ	FD Autofrenante in D.C. Brake motor in D.C. Gleichstrom-Bremsmotor				FS Autofrenante in D.C. Brake motor in D.C. Gleichstrom-Bremsmotor				FP Autofrenante in D.C. Brake motor in D.C. Gleichstrom-Bremsmotor			
	CF	Z <sub>0</sub>	PB		CF	Z <sub>0</sub>	PB		CF	Z <sub>0</sub>	PB	
	[Nm]	[1/h]	[W]		[Nm]	[1/h]	[W]		[Nm]	[1/h]	[W]	
MFA71B	5	25000	20	9.0	4	25000	17	8.0	7.5	25000	11.5	7.1
MFA80A	10	19000	25	10.0	8	19000	34	10.0	15	19000	16	9.0
MFA80B	10	16000	25	11.0	8	16000	34	12.0	15	16000	16	9.8
MFA90L	16	13500	30	19.0	8	13500	34	17.0	15	13500	16	14.6
MFA90LB	16	13000	30	24.0	8	13000	34	19.0	15	13000	16	16.6
MFA100B	32	7000	40	28.5	11	7000	40	26.5	30	7000	21	22.9
MFA100BL	32	7000	40	30.5	11	7000	40	28.5	30	7000	21	24.9

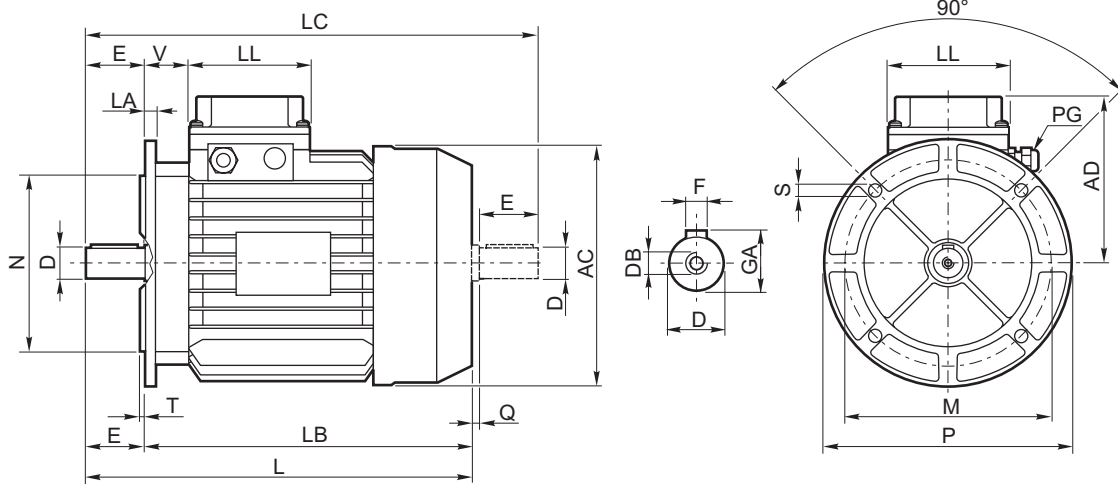
TRIFASE  
THREE-PHASE  
DREHSTROM

T-H-I-D-S-R (56 - 160)

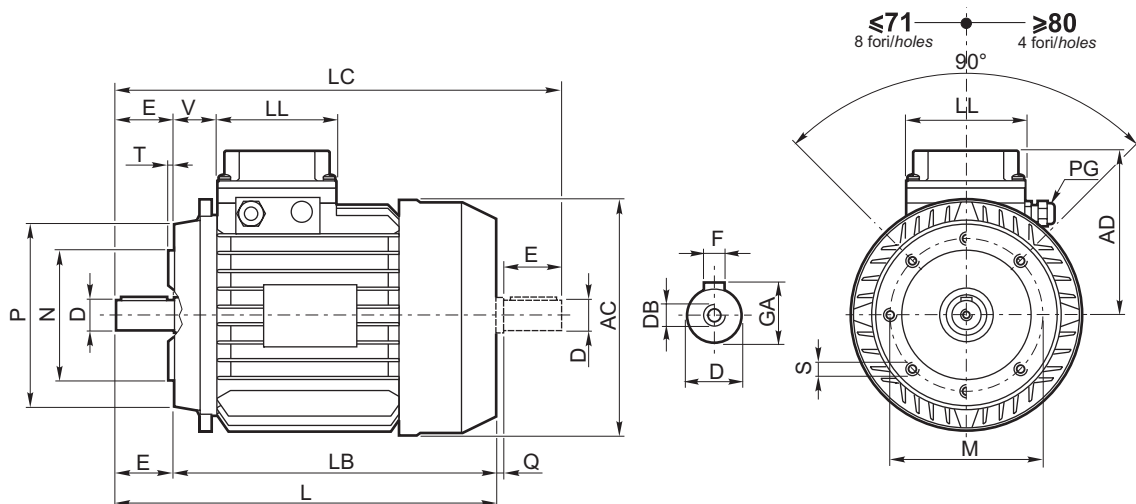
B3



B5



B14



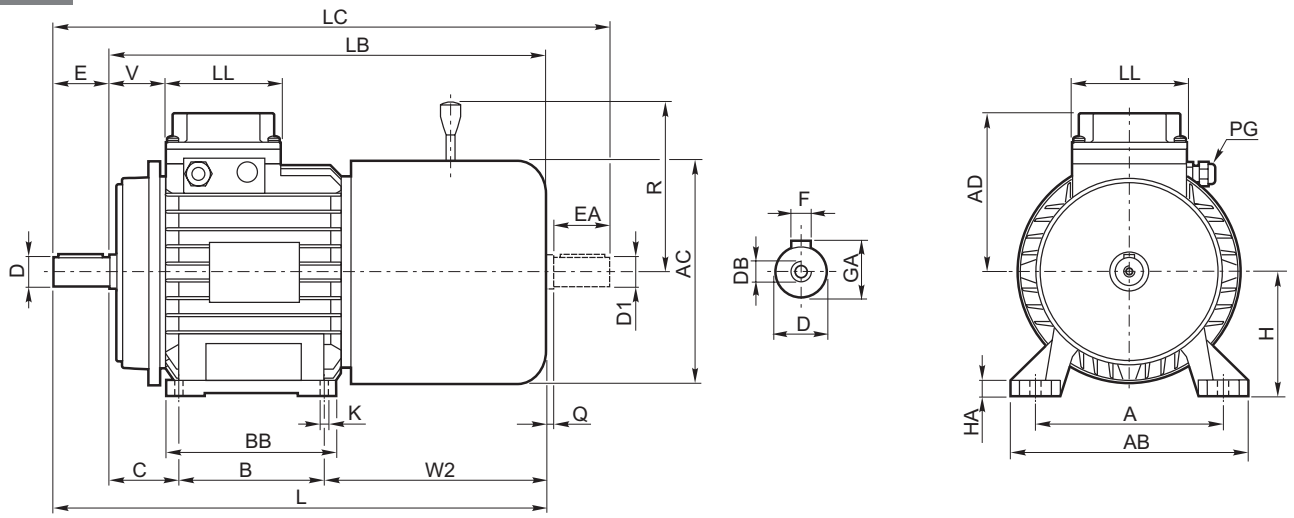
T - H - I - D - S - R (gr. 56 - 160)

Grandezza Size Größe	Albero / Shaft / Welle						Cassa / Box / Gehäuse									Motore / Motor / Motor							
	D	DB	E	F	GA	Q	A	AB	B	BB	C	H	HA	K	W2	AC	AD	L	LB	LC	LL	PG	V
56	9	M4	20	3	10.2	3	90	108	71	90	36	56	8	6	63	110	95	188	168	211	76	M16	23.5
63	11	M4	23	4	12.5	3	100	120	80	100	40	63	8	7	72	123	97	208	185	234	66	M20	34.5
71	14	M5	30	5	16.0	3	112	135	90	109	45	71	10	7	84	140	108	245	220	278	66	M20	42.5
80	19	M6	40	6	21.5	3	125	155	100	125	50	80	12	9	89	159	120	278	238	321	91	M20	40.5
90S	24	M8	50	8	27.0	5	140	170	100	128	56	90	13	9	96	176	131	305	255	360	91	M20	40.5
90L	24	M8	50	8	27.0	5	140	170	125	154	56	90	13	9	96	176	131	330	280	385	91	M20	40.5
100	28	M10	60	8	31.0	5	160	192	140	165	63	100	14	12	104	195	142	369	309	434	91	M20	57.5
112	28	M10	60	8	31.0	5	190	220	140	180	70	112	15	12	118	219	154	388	328	453	91	M20	57.5
132S	38	M12	80	10	41.0	5	216	260	140	180	89	132	16	12	140	258	175	448	368	533	105	M32	65
132M	38	M12	80	10	41.0	5	216	260	178	216	89	132	16	12	140	258	175	490	410	576	105	M32	65
160M	42	M16	110	12	45.0	5	254	318	210	260	108	160	18	13	160	315	220	603	493	703	185	M32	118
160L	42	M16	110	12	45.0	5	254	318	254	304	108	160	18	13	160	315	220	647	557	747	185	M32	118

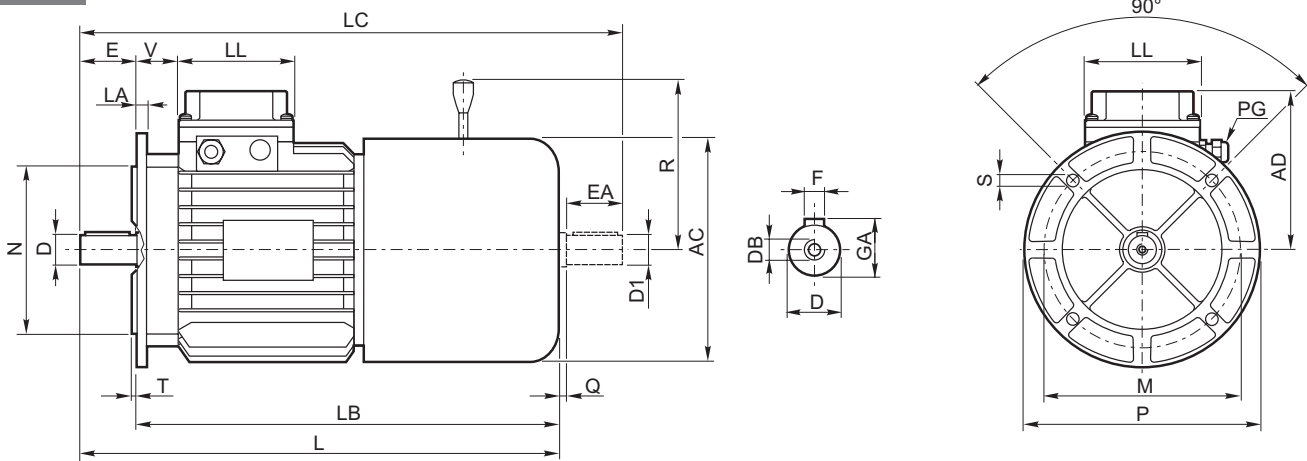
Grandezza Size Größe	Albero / Shaft / Welle						Motore / Motor / Motor								Flangia / Flange / Flansch					
	D	DB	E	F	GA	Q	AC	AD	L	LB	LC	LL	PG	V	LA	M	N	P	S	T
56	9	M4	20	3	10.2	3	110	95	188	168	211	76	M16	23.5	7	100	80	120	7	2.5
63	11	M4	23	4	12.5	3	123	97	208	185	234	66	M20	34.5	10	115	95	140	9.5	3
71	14	M5	30	5	16.0	3	140	108	245	220	278	66	M20	42.5	10	130	110	160	9.5	3.5
80	19	M6	40	6	21.5	3	159	120	278	238	321	91	M20	40.5	12	165	130	200	11.5	3.5
90S	24	M8	50	8	27.0	5	176	131	305	255	360	91	M20	40.5	12	165	130	200	11.5	3.5
90L	24	M8	50	8	27.0	5	176	131	330	280	385	91	M20	40.5	12	165	130	200	11.5	3.5
100	28	M10	60	8	31.0	5	195	142	369	314	434	91	M20	57.5	14	215	180	250	14.5	4
112	28	M10	60	8	31.0	5	219	154	388	328	453	91	M20	57.5	14	215	180	250	14.5	4
132S	38	M12	80	10	41.0	5	258	175	448	368	533	105	M32	65	14	265	230	300	14.5	4
132M	38	M12	80	10	41.0	5	258	175	490	410	576	105	M32	65	14	265	230	300	14.5	4
160M	42	M16	110	12	45.0	5	315	220	588	478	703	185	M32	118	15	300	250	350	18.5	5
160L	42	M16	110	12	45.0	5	315	220	632	522	747	185	M32	118	15	300	250	350	18.5	5

Grandezza Size Größe	Albero / Shaft / Welle						Motore / Motor / Motor								Flangia / Flange / Flansch					
	D	DB	E	F	GA	Q	AC	AD	L	LB	LC	LL	PG	V	M	N	P	S	T	
50A	9	M4	20	3	10.2	-	104	77	145	125	-	56	M16	20	65	50	80	M5	2.5	
50B	9	M4	20	3	10.2	-	104	77	162	142	-	56	M16	20	65	50	80	M5	2.5	
56	9	M4	20	3	10.2	3	110	95	188	168	211	76	M16	23.5	65	50	80	M5	2.5	
63	11	M4	23	4	12.5	3	123	97	208	185	234	66	M20	34.5	75	60	90	M5	3	
71	14	M5	30	5	16.0	3	140	108	245	220	278	66	M20	42.5	85	70	105	M6	3.5	
80	19	M6	40	6	21.5	3	159	120	278	238	321	91	M20	40.5	100	80	120	M6	3.5	
90S	24	M8	50	8	27.0	5	176	131	305	255	360	91	M20	40.5	115	95	140	M8	3.5	
90L	24	M8	50	8	27.0	5	176	131	330	280	385	91	M20	40.5	115	95	140	M8	3.5	
100	28	M10	60	8	31.0	5	195	142	369	309	434	91	M20	57.5	130	110	160	M8	4	
112	28	M10	60	8	31.0	5	219	154	388	328	453	91	M20	57.5	130	110	160	M8	4	
132S	38	M12	80	10	41.0	5	258	175	448	368	533	105	M32	65	165	130	200	M10	4	
132M	38	M12	80	10	41.0	5	258	175	490	410	576	105	M32	65	165	130	200	M10	4	
160M	42	M16	110	12	45.0	5	315	220	588	478	703	185	M32	118	215	180	250	M12	4	
160L	42	M16	110	12	45.0	5	315	220	632	522	747	185	M32	118	215	180	250	M12	4	

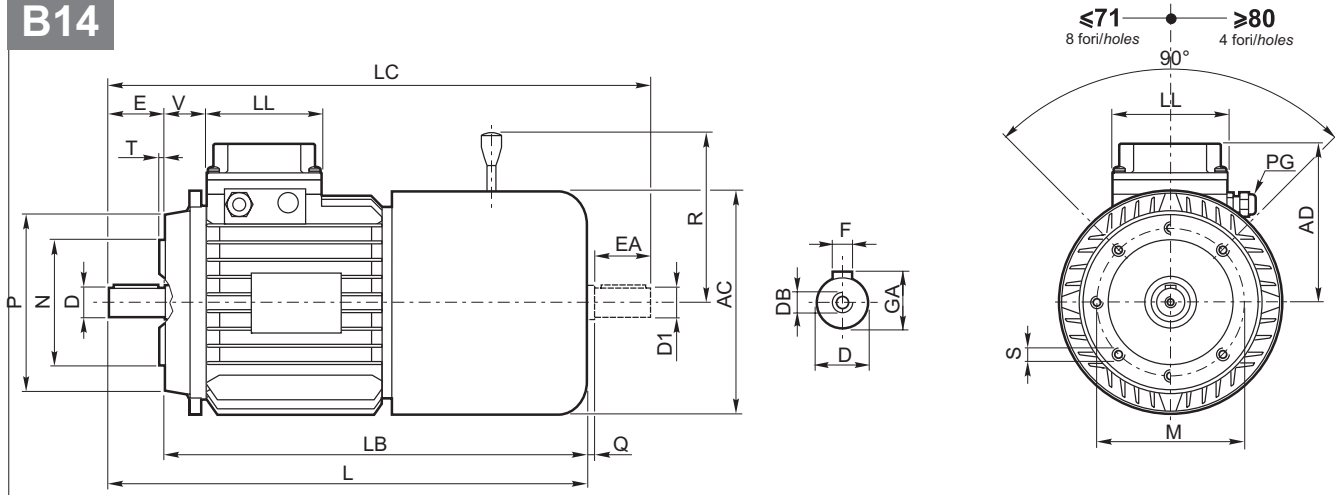
**B3**



**B5**



**B14**



TRIFASE  
THREE-PHASE  
DREHSTROM

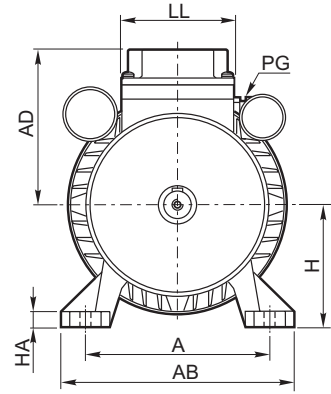
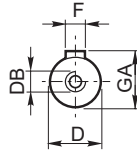
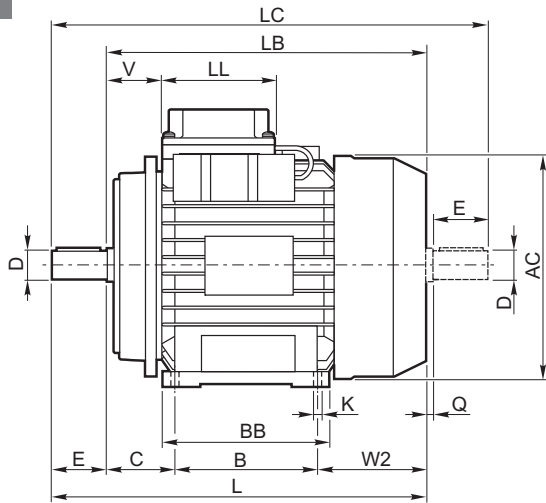
TA - HA - IA - DA - SA - RA (gr. 56 - 160)

Grandezza Size Größe	Albero / Shaft / Welle								Cassa / Box / Gehäuse								Motore / Motor / Motor									
	D	D1	DB	E	EA	F	GA	Q	A	AB	B	BB	C	H	HA	K	W2	AC	AD	L	LB	LC	LL	PG	R	V
56	9	9	M4	20	20	3	10.2	3	90	108	71	90	36	56	8	6	-	110	95	220	200	255	76	M16	90	23.5
63	11	11	M4	23	23	4	12.5	3	100	120	80	100	40	63	8	7	121	123	97	257	234	283	66	M20	98	34.5
71	14	11	M5	30	23	5	16.0	3	112	135	90	109	45	71	10	7	136	140	108	297	267	323	66	M20	98	42.5
80	19	14	M6	40	30	6	21.5	3	125	155	100	125	50	80	12	9	147	159	120	336	296	366	91	M20	111	40.5
90S	24	14	M8	50	30	8	27.0	5	140	170	100	128	56	90	13	9	160	176	131	369	319	404	91	M20	129	40.5
90L	24	14	M8	50	30	8	27.0	5	140	170	125	154	56	90	13	9	160	176	131	394	344	429	91	M20	129	40.5
100	28	24	M10	60	50	8	31.0	5	160	192	140	165	63	100	14	12	169	195	142	434	374	489	91	M20	139	57.5
112	28	24	M10	60	50	8	31.0	5	190	220	140	180	70	112	15	12	197	219	154	467	407	522	91	M20	161	57.5
132S	38	28	M12	80	60	10	41.0	5	216	260	140	180	89	132	16	12	230	258	175	570	490	635	105	M32	186	65
132M	38	28	M12	80	60	10	41.0	5	216	260	178	216	89	132	16	12	230	258	175	600	520	665	105	M32	186	65
160M	42	28	M16	110	60	12	45.0	5	254	318	210	260	108	160	18	13	307	315	220	803	625	870	185	M32	242	118
160L	42	28	M16	110	60	12	45.0	5	254	318	254	304	108	160	18	13	307	315	220	818	660	885	185	M32	242	118

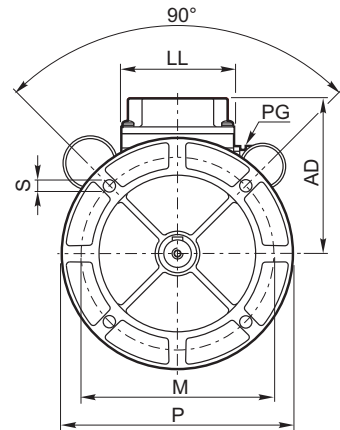
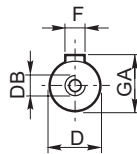
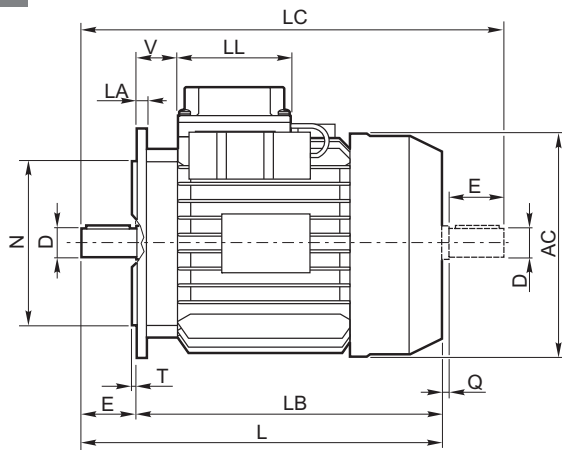
Grandezza Size Größe	Albero / Shaft / Welle								Motore / Motor / Motor								Flangia / Flange / Flansch						
	D	D1	DB	E	EA	F	GA	Q	AC	AD	L	LB	LC	LL	PG	R	V	LA	M	N	P	S	T
56	9	9	M4	20	20	3	10.2	3	110	95	220	200	255	76	M16	90	23.5	7	100	80	120	7.0	2.5
63	11	11	M4	23	23	4	12.5	3	123	97	257	234	283	66	M20	98	34.5	10	115	95	140	9.5	3.0
71	14	11	M5	30	23	5	16.0	3	140	108	297	267	323	66	M20	98	42.5	10	130	110	160	9.5	3.5
80	19	14	M6	40	30	6	21.5	3	159	120	336	296	366	91	M20	111	40.5	12	165	130	200	11.5	3.5
90S	24	14	M8	50	30	8	27.0	5	176	131	369	319	404	91	M20	129	40.5	12	165	130	200	11.5	3.5
90L	24	14	M8	50	30	8	27.0	5	176	131	394	344	429	91	M20	129	40.5	12	165	130	200	11.5	3.5
100	28	24	M10	60	50	8	31.0	5	195	142	434	374	489	91	M20	139	57.5	14	215	180	250	14.5	4.0
112	28	24	M10	60	50	8	31.0	5	219	154	467	407	522	91	M20	161	57.5	14	215	180	250	14.5	4.0
132S	38	28	M12	80	60	10	41.0	5	258	175	570	490	635	105	M32	186	65	14	265	230	300	14.5	4.0
132M	38	28	M12	80	60	10	41.0	5	258	175	600	520	665	105	M32	186	65	14	265	230	300	14.5	4.0
160M	42	28	M16	110	60	12	45.0	5	315	220	803	625	870	185	M32	242	118	15	300	250	350	18.5	5.0
160L	42	28	M16	110	60	12	45.0	5	315	220	818	660	885	185	M32	242	118	15	300	250	350	18.5	5.0

Grandezza Size Größe	Albero / Shaft / Welle								Motore / Motor / Motor								Flangia / Flange / Flansch					
	D	D1	DB	E	EA	F	GA	Q	AC	AD	L	LB	LC	LL	PG	R	V	M	N	P	S	T
56	9	9	M4	20	20	3	10.2	3	110	95	220	200	255	76	M16	90	23.5	65	50	80	M5	2.5
63	11	11	M4	23	23	4	12.5	3	123	97	257	234	283	66	M20	98	34.5	75	60	90	M5	3.0
71	14	11	M5	30	23	5	16.0	3	140	108	297	267	323	66	M20	98	42.5	85	70	105	M6	3.5
80	19	14	M6	40	30	6	21.5	3	159	120	336	296	366	91	M20	111	40.5	100	80	120	M6	3.5
90S	24	14	M8	50	30	8	27.0	5	176	131	369	319	404	91	M20	129	40.5	115	95	140	M8	3.5
90L	24	14	M8	50	30	8	27.0	5	176	131	394	344	429	91	M20	129	40.5	115	95	140	M8	3.5
100	28	24	M10	60	50	8	31.0	5	195	142	434	374	489	91	M20	139	57.5	130	110	160	M8	4.0
112	28	24	M10	60	50	8	31.0	5	219	154	467	407	522	91	M20	161	57.5	130	110	160	M8	4.0
132S	38	28	M12	80	60	10	41.0	5	258	175	570	490	635	105	M32	186	65	165	130	200	M10	4.0
132M	38	28	M12	80	60	10	41.0	5	258	175	600	520	665	105	M32	186	65	165	130	200	M10	4.0
160M	42	28	M16	80	60	12	45.0	5	315	220	803	625	870	185	M32	242	118	215	180	250	M12	4.0
160L	42	28	M16	80	60	12	45.0	5	315	220	818	660	885	185	M32	242	118	215	180	250	M12	4.0

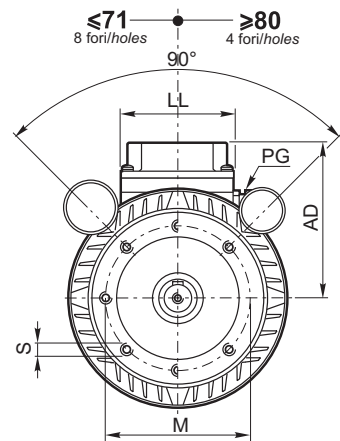
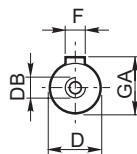
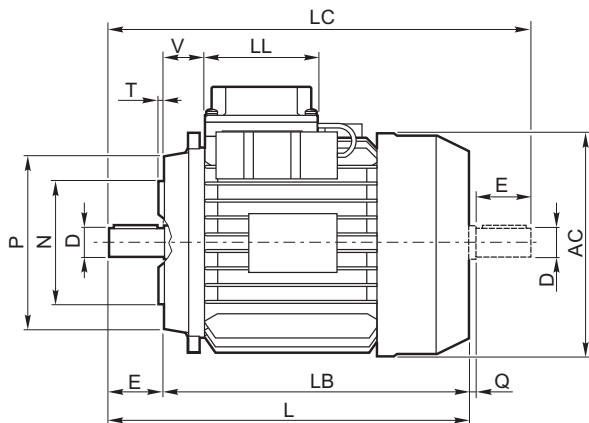
**B3**



**B5**



**B14**



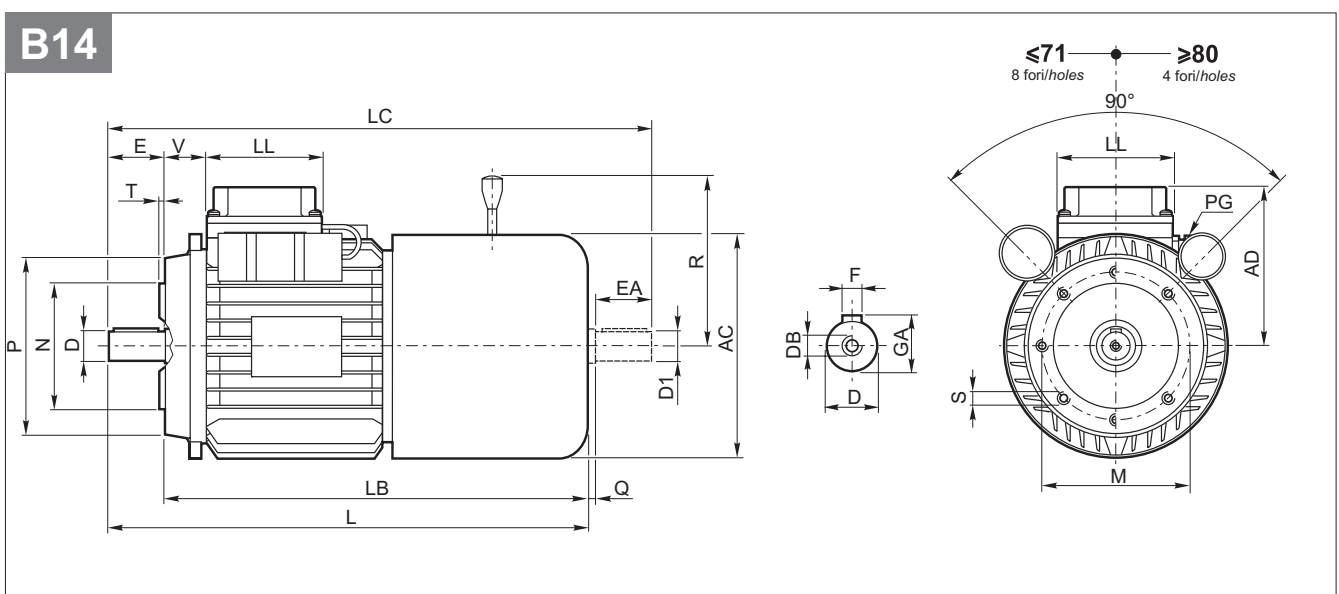
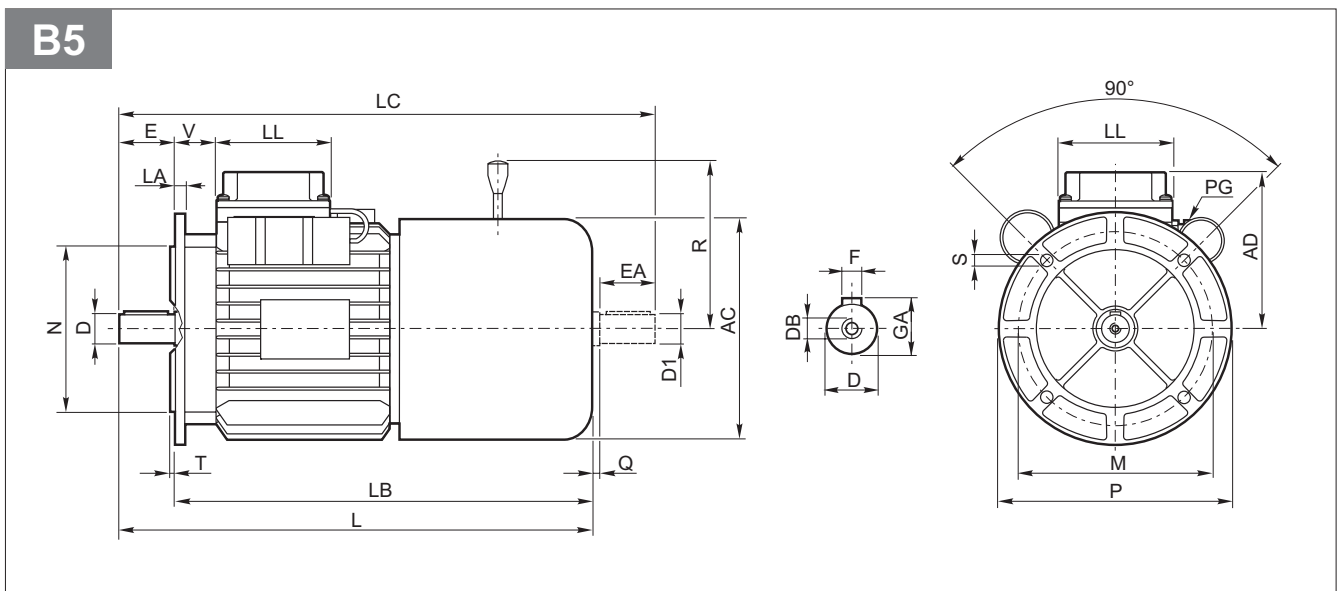
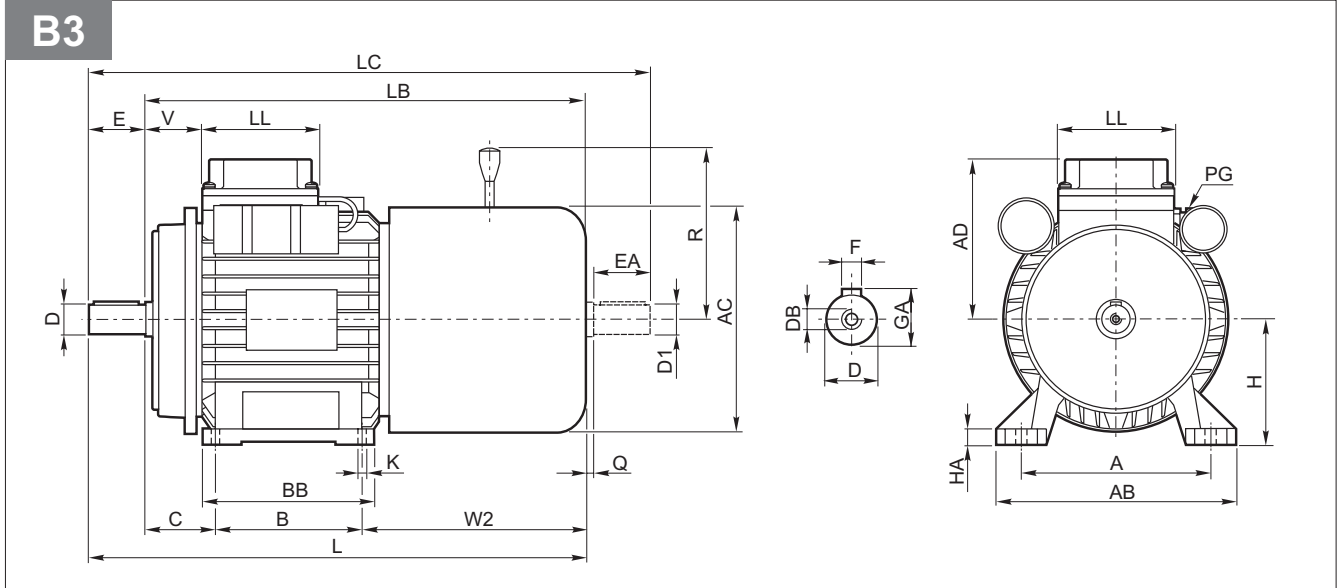
MONOFASE  
SINGLE-PHASE  
EINPHASEN

M - MD - MF - MR - ME (gr. 50 - 100)

Grandezza Size Größe	Albero / Shaft / Welle						Cassa / Box / Gehäuse										Motore / Motor / Motor							
	D	DB	E	F	GA	Q	A	AB	B	BB	C	H	HA	K	W2	AC	AD	L	LB	LC	LL	PG	V	
56	9	M4	20	3	10.2	3	90	108	71	90	36	56	8	6	63	110	95	188	168	211	76	M16	23.5	
63	11	M4	23	4	12.5	3	100	120	80	100	40	63	8	7	72	123	97	208	185	234	66	M20	34.5	
71	14	M5	30	5	16.0	3	112	135	90	109	45	71	10	7	84	140	108	245	220	278	66	M20	42.5	
80	19	M6	40	6	21.5	3	125	155	100	125	50	80	12	9	89	159	120	278	238	321	91	M20	40.5	
90S	24	M8	50	8	27.0	5	140	170	100	128	56	90	13	9	96	176	131	305	255	360	91	M20	40.5	
90L	24	M8	50	8	27.0	5	140	170	125	154	56	90	13	9	96	176	131	330	280	385	91	M20	40.5	
100	28	M10	60	8	31.0	5	160	192	140	165	63	100	14	12	104	195	142	369	309	434	91	M20	57.5	

Grandezza Size Größe	Albero / Shaft / Welle						Motore / Motor / Motor								Flangia / Flange / Flansch					
	D	DB	E	F	GA	Q	AC	AD	L	LB	LC	LL	PG	V	LA	M	N	P	S	T
56	9	M4	20	3	10.2	3	110	95	188	168	211	76	M16	23.5	7	100	80	120	7	2.5
63	11	M4	23	4	12.5	3	123	97	208	185	234	66	M20	34.5	10	115	95	140	9.5	3.0
71	14	M5	30	5	16.0	3	140	108	245	220	278	66	M20	42.5	10	130	110	160	9.5	3.5
80	19	M6	40	6	21.5	3	159	120	278	238	321	91	M20	40.5	12	165	130	200	11.5	3.5
90S	24	M8	50	8	27.0	5	176	131	305	255	360	91	M20	40.5	12	165	130	200	11.5	3.5
90L	24	M8	50	8	27.0	5	176	131	330	280	385	91	M20	40.5	12	165	130	200	11.5	3.5
100	28	M10	60	8	31.0	5	195	142	369	309	434	91	M20	57.5	14	215	180	250	14.5	4.0

Grandezza Size Größe	Albero / Shaft / Welle						Motore / Motor / Motor								Flangia / Flange / Flansch				
	D	DB	E	F	GA	Q	AC	AD	L	LB	LC	LL	PG	V	M	N	P	S	T
50A	9	M4	20	3	10.2	-	104	77	145	125	-	56	M16	20	65	50	80	M5	2.5
50B	9	M4	20	3	10.2	-	104	77	162	142	-	56	M16	20	65	50	80	M5	2.5
56	9	M4	20	3	10.2	3	110	95	188	168	211	76	M16	23.5	65	50	80	M5	2.5
63	11	M4	23	4	12.5	3	123	97	208	185	234	66	M20	34.5	75	60	90	M5	3.0
71	14	M5	30	5	16.0	3	140	108	245	220	278	66	M20	42.5	85	70	105	M6	3.5
80	19	M6	40	6	21.5	3	159	120	278	238	321	91	M20	40.5	100	80	120	M6	3.5
90S	24	M8	50	8	27.0	5	176	131	305	255	360	91	M20	40.5	115	95	140	M8	3.5
90L	24	M8	50	8	27.0	5	176	131	330	280	385	91	M20	40.5	115	95	140	M8	3.5
100	28	M10	60	8	31.0	5	195	142	369	309	434	91	M20	57.5	130	110	160	M8	4.0





MONOFASE  
SINGLE-PHASE  
EINPHASEN

MA - MDA - MFA - MC - MRA - MEA (gr. 56 - 100)

Grandezza Size Größe	Albero / Shaft / Welle								Cassa / Box / Gehäuse								Motore / Motor / Motor									
	D	D1	DB	E	EA	F	GA	Q	A	AB	B	BB	C	H	HA	K	W2	AC	AD	L	LB	LC	LL	PG	R	V
56	9	9	M4	20	20	3	10.2	3	90	108	71	90	36	56	8	6	-	110	95	220	200	255	76	M16	90	23.5
63	11	11	M4	23	23	4	12.5	3	100	12	80	100	40	63	8	7	121	123	97	257	234	283	66	M20	98	34.5
71	14	11	M5	30	23	5	16.0	3	112	135	90	109	45	71	10	7	136	140	108	297	267	323	66	M20	98	42.5
80	19	14	M6	40	30	6	21.5	3	125	155	100	125	50	80	12	9	147	159	120	336	296	366	91	M20	111	40.5
90S	24		M8	50	30	8	27.0	5	140	170	100	128	56	90	13	9	160	176	131	369	319	404	91	M20	129	40.5
90L	24	14	M8	50	30	8	27.0	5	140	170	125	154	56	90	13	9	160	176	131	394	344	429	91	M20	129	40.5
100	28	24	M10	60	50	8	31.0	5	160	192	140	165	63	100	14	12	169	195	142	434	374	489	91	M20	139	57.5

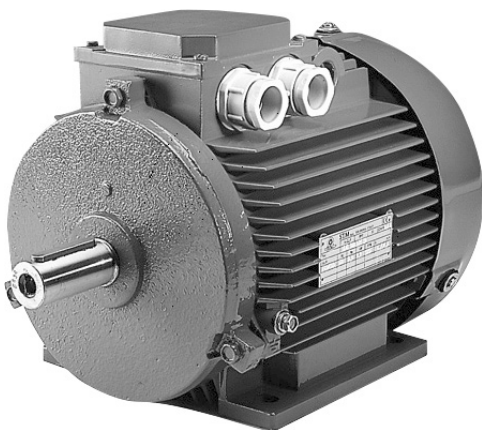
Grandezza Size Größe	Albero / Shaft / Welle								Motore / Motor / Motor								Flangia / Flange / Flansch						
	D	D1	DB	E	EA	F	GA	Q	AC	AD	L	LB	LC	LL	PG	R	V	LA	M	N	P	S	T
56	9	9	M4	20	20	3	10.2	3	110	95	220	200	255	76	M16	90	23.5	7	100	80	120	7	2.5
63	11	11	M4	23	23	4	12.5	3	123	97	257	234	283	66	M20	98	34.5	10	115	95	140	9.5	3.0
71	14	11	M5	30	23	5	16.0	3	140	108	297	267	323	66	M20	98	42.5	10	130	110	160	9.5	3.5
80	19	14	M6	40	30	6	21.5	3	159	120	336	296	366	91	M20	111	40.5	12	165	130	200	11.5	3.5
90S	24	14	M8	50	30	8	27.0	5	176	131	369	319	404	91	M20	129	40.5	12	165	130	200	11.5	3.5
90L	24	14	M8	50	30	8	27.0	5	176	131	394	344	429	91	M20	129	40.5	12	165	130	200	11.5	3.5
100	28	24	M10	60	50	8	31.0	5	195	142	434	374	489	91	M20	139	57.5	14	215	180	250	14.5	4.0

Grandezza Size Größe	Albero / Shaft / Welle								Motore / Motor / Motor								Flangia / Flange / Flansch					
	D	D1	DB	E	EA	F	GA	Q	AC	AD	L	LB	LC	LL	PG	R	V	M	N	P	S	T
56	9	9	M4	20	20	3	10.2	3	110	95	220	200	255	76	M16	90	23.5	65	50	80	M5	2.5
63	11	11	M4	23	23	4	12.5	3	123	97	257	234	283	66	M20	98	34.5	75	60	90	M5	3.0
71	14	11	M5	30	23	5	16.0	3	140	108	297	267	323	66	M20	98	42.5	85	70	105	M6	3.5
80	19	14	M6	40	30	6	21.5	3	159	120	336	296	366	91	M20	111	40.5	100	80	120	M6	3.5
90S	24	14	M8	50	30	8	27.0	5	176	131	369	319	404	91	M20	129	40.5	115	95	140	M8	3.5
90L	24	14	M8	50	30	8	27.0	5	176	131	394	344	429	91	M20	129	40.5	115	95	140	M8	3.5
100	28	24	M10	60	50	8	31.0	5	195	142	434	374	489	91	M20	139	57.5	130	110	160	M8	4.0



**1.0 MOTORI VELA  
VELA MOTORS  
MOTOREN VELA****VL**

				Pag. Page Seite
1.1	Forme costruttive	<i>Models</i>	Bauformen	B2
1.2	Designazione	<i>Designation</i>	Typenschlüssel	B3
1.3	Cuscinetti e materiali	<i>Bearings and materials</i>	Kugellager und Materialien	B4
1.4	Grado di protezione	<i>Protection level</i>	Schutzart	B5
1.5	Ventilazione	<i>Ventilation</i>	Belüftung	B5
1.6	Senso di rotazione	<i>Rotation direction</i>	Drehsinn	B5
1.7	Livello di pressione sonora	<i>Noise pressure</i>	Schalldruckpegel	B6
1.8	Vibrazioni	<i>Vibrations</i>	Vibrationen	B6
1.9	Scatola morsetti e ingresso cavi	<i>Terminal board box and cable slots</i>	Klemmenkasten und kabeleingang	B7
1.10	Tensione di alimentazione e frequenza	<i>Power voltage and frequency</i>	Versorgungsspannung und frequenz	B7
1.11	Potenza	<i>Power</i>	Leistung	B8
1.12	Rendimento e fattore di potenza	<i>Efficiency and power factor</i>	Ausbringung und leistungsfaktor	B8
1.13	Isolamento	<i>Insulation rating</i>	Isolierung	B9
1.14	Tipo di servizio	<i>Service type</i>	Betriebsart	B9
1.15	Norme di riferimento	<i>Reference standard</i>	Bezugsnormen	B9
1.16	Dati tecnici	<i>Engineering data</i>	Technische daten	B10
1.17	Carichi radiali e assiali	<i>Radial and axial loads</i>	Radial- und Axiallasten	B13
1.18	Dimensioni	<i>Dimensions</i>	Abmessungen	B14



**1.1 FORME COSTRUTTIVE**

**1.1 MODELS**

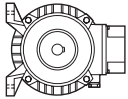
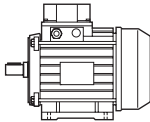
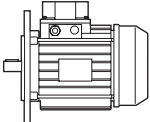
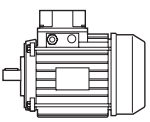
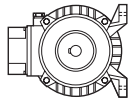
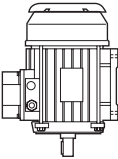
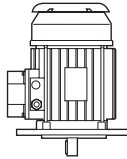
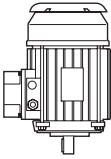
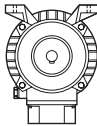
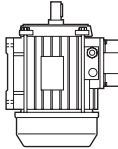
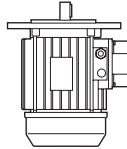
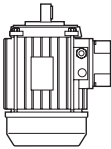
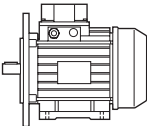
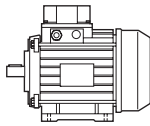
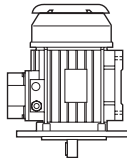
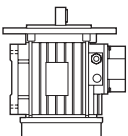
**1.1 BAUFORMEN**

I motori VELA possono essere forniti nelle seguenti forme costruttive in funzione della grandezza motore secondo le norme IEC 34-7 e CEI 2-14 fascicolo 724.

VELA motors are available in different models according to the size of the motor, in compliance with IEC 34-7 regulations, file 724.

Die VELA Motoren können in den folgenden Bauformen in Abhängigkeit von der Motorgröße gemäß IEC 34-7 und CEI 2-14 Heft 724 geliefert werden.

Tab. 1.1

<b>Motori con piedi B3</b> <i>Motors with feet B3</i> Motoren mit Füßen B3		<b>Motori con Flangia B5</b> <i>Flange-mounted motors B5</i> Motoren mit Flansch B5		<b>Motori con Flangia B14</b> <i>Flange-mounted motors B14</i> Motoren mit Flansch B14	
IM 1051 (IM B6) 	IM 1001 (IM B3) 	IM 3001 (IM B5) 	IM 3601 (IM B14) 		
IM 1061 (IM B7) 	IM 1011 (IM V5) 	IM 3031 (IM V1) 	IM 3631 (IM V18) 		
IM 1071 (IM B8) 	IM 1031 (IM V6) 	IM 3031 (IM V3) 	IM 3631 (IM V19) 		
IM 2001 (IM B35) 	IM 2101 (IM B34) 	IM 2011 (IM V15) 	IM 2031 (IM V36) 		
B3/B5	B3/B14	V3/V5	V3/V6		

**1.2 DESIGNAZIONE**

**1.2 DESIGNATION**

**1.2 TYPENSCHLÜSSEL**

Descrizione Description Beschreibung	<b>VL</b>	<b>63</b>	<b>A</b>	<b>4</b>	<b>B5</b>	<b>—</b>	<b>55</b>	<b>F</b>	<b>—</b>
	Tipo Type Typ	Grandezza Size Größe	Lunghezza Length Länge	n° poli Pole n. Polzahl	<b>[*1]</b>	<b>[*2]</b>	<b>[*3]</b>	<b>[*4]</b>	<b>[*5]</b>
<b>MOTORI TRIFASE / THREE-PHASE MOTORS / DREHSTROMMOTOREN</b>									
Trifase Three-Phase Drehstrom	<b>VL</b>	56...315	A ... ML	2 4 6	B5 B14 *B3 *B35 (B3/B5) *B34 (B3/B14) B3L4 B3L2	— A B  (Vedi tabella) (See tables) (Siehe Tabellen)	55	F	—

**[\*1] Forma**

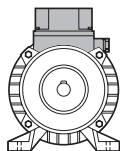
Nelle forme costruttive con piede, la scatola morsetti può essere orientata in tre posizioni.

**[\*1] Design version**

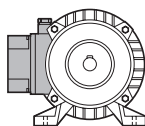
On design versions with feet, the terminal box can be set in three positions.

**[\*1] Forma**

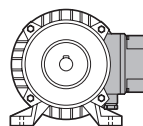
Bei den Bauformen mit Fuß kann der Klemmenkasten in drei Positionen ausgerichtet werden.



**B3**  
standard



**B3L4**



**B3L2**

**[\*2] Tensione e frequenza**


Specificare tensione STD o a richiesta.

**[\*2] Voltage and frequency**

Specify either STD voltage or upon request.

**[\*2] Spannung und Frequenz**

Spannung STD oder auf Wunsch angeben.

	Tensione / Voltage / Spannung [V]		Indicazione Designazione Designation indication Bezeichnung
	(50 Hz)	(60Hz)	
<b>63 - 112</b>	230/400	277/480	—
<b>132</b>	230/400	277/480	<b>A</b>
<b>132</b>	400 Δ	480 Δ	<b>B</b>
<b>&gt; 160</b>	400 Δ	480 Δ	—

**[\*3] Grado di protezione**

**[\*3] Protection level**

**[\*3] Schutzart**

Indicazione designazione Designation indication Bezeichnung	<b>IP55</b>
	Standard
	<b>55</b>

**[\*4] Classe di isolamento**

**[\*4] Insulation class**

**[\*4] Isolierstoffklasse**

Indicazione designazione Designation indication Bezeichnung	<b>CL F</b> Standard
	<b>F</b>

**[\*5] Tipo di servizio** (pag. B9)

**[\*5] Service type** (page B9)

**[\*5] Betriebsart** (Seite B9)

### 1.3 CUSCINETTI E MATERIALI

I cuscinetti dei motori fino alla grandezza 200 sono del tipo 2RS autolubrificati e precaricati; per le grandezze superiori (225-315) sono previsti cuscinetti autolubrificati con la possibilità di introdurre del nuovo grasso il quale sostituirà parzialmente quello usato.

Per tutti i motori utilizzati nelle posizioni di montaggio orizzontali e in assenza di carichi radiali e assiali, la durata massima calcolata è di 40.000 ore. In presenza dei carichi massimi indicati la durata calcolata è di 20.000 ore.

### 1.3 BEARINGS AND MATERIALS

Motors up to size 200 feature 2RS-type autolubricated and preloaded bearings; motors of larger size (225-315) have autolubricated bearings that allow the application of further grease to partially substitute the consumed lubricant.


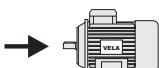

All motors used in horizontal assembling positions and without radial and axial loads have a maximum calculated duration of 40.000 hours. When the maximum loads indicated are applied, the motors have a calculated duration of 20.000 hours.

### 1.3 KUGELLAGER UND MATERIALIEN

Die Lager der Motoren bis zu Baugröße 200 sind vom Typ 2RS mit Dauerschmierung und Vorspannung. Für größere Baugrößen (225-315) sind dauergeschmierte Lager vorgesehen, die nachgefettet werden können, um das verwendete Fett teilweise zu ersetzen.

Für alle Motoren in waagerechter Einbaulage und bei Fehlen von Axial- und Radialbelastungen ist die maximale Standzeit mit 40.000 Stunden angesetzt. Bei Vorhandensein der angegebenen Maximalbelastungen beträgt die berechnete Standzeit mit 20.000 Stunden.

Tab. 1.2

	Cuscinetti Bearings Kugellager		Materiali Materials Materialien					
	Lato A Side A Seite A 	Lato B Side B Seite B 	Cassa Body Gehäuse	Scudi Shields Lagerschilder	Scatola morsettiera Terminal board box Klemmenkasten	Ventola Fan Lüfter	Copriventola Fan cover Lüfterhaube	
63	6201	6201	Al	Al	Al	Th	Th	
71	6202	6202						
80	6204	6204						
90	6205	6205						
100	6306	6306						
112	6306	6306	Ci	Ci		Al		St
132	6308	6308						
160	6309	6309						
180M	6310	6310						
180L	6312	6312						
200L	6312	6312						
200LA	6312	6312						
200LB	6313	6313						
225	6313	6213		Ci	Ci	Al		
250	6314	6214						
280	6317	6317						
315M	NU317EC	6317						
315L	NU319EC	6319						

**Al** Alluminio  
Aluminium  
Aluminium

**Th** Termoplastica  
Thermoplastic  
Thermoplast

**Ci** Ghisa  
Cast iron  
Roheisen

**St** Acciaio  
Steel  
Stahl

### 1.4 GRADO DI PROTEZIONE

I motori VELA sono forniti con protezione IP55 (secondo le Norme CEI 2-16 e IEC 34-5).

Se installati all'aperto è necessario proteggere i motori dall'irraggiamento diretto del sole e, se montati verticalmente, dagli agenti atmosferici.

### 1.4 PROTECTION LEVEL

VELA motors feature IP55 protection (in compliance with CEI 2-16 and IEC 34-5 regulations).

Motors must be protected from direct sunlight if installed outdoors and, when assembled vertically, they must be protected from atmospheric agents.

### 1.4 SCHUTZART

Die VELA Motoren werden in der Schutzart IP55 geliefert (gemäß CEI 2-16 und IEC 34-5).

Wenn sie im Freien installiert werden, sind sie vor direkter Sonneneinstrahlung und, bei senkrechter Einbaulage, vor Witterungseinflüssen zu schützen.

### 1.5 VENTILAZIONE

Il raffreddamento del motore è affidato a una ventola a pale radiali la quale assolve la sua funzione nei due sensi di rotazione.

Per garantire una ventilazione efficace è necessario prevedere durante l'installazione del motore uno spazio S adeguato fra il copriventola e l'eventuale parete.

### 1.5 VENTILATION

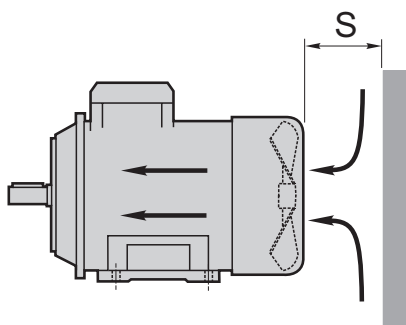
Motor cooling is provided by a radialblade fan working in both rotation directions.

If the motor is installed in proximity to a wall, adequate space S must be allowed between the fan cover and the wall during installation for the ventilation system to be effective.

### 1.5 BELÜFTUNG

Die Motorkühlung wird von einem Lüfterrad mit Radialschaufeln übernommen, das in beide Richtungen drehen kann.

Für eine wirksame Kühlung ist bei der Installation des Motors ein angemessener Abstand S zwischen der Lüfterhaube und einer eventuell vorhandenen Wand zu wahren.



### 1.6 SENSO DI ROTAZIONE

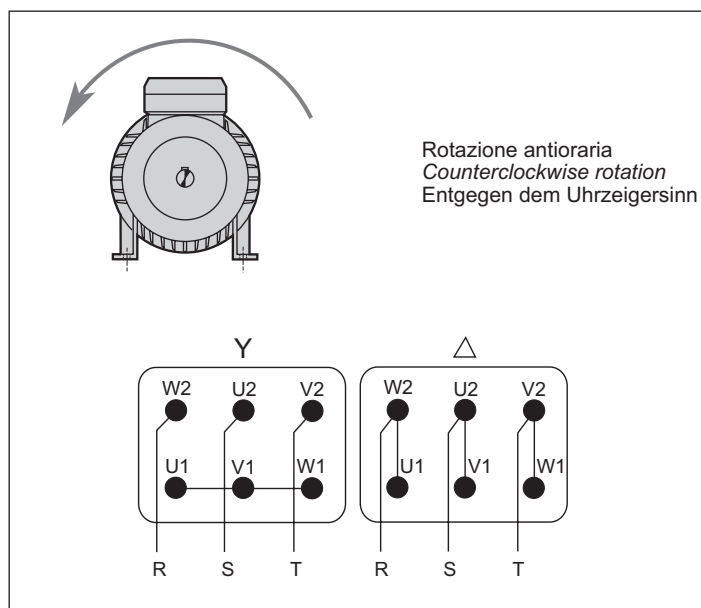
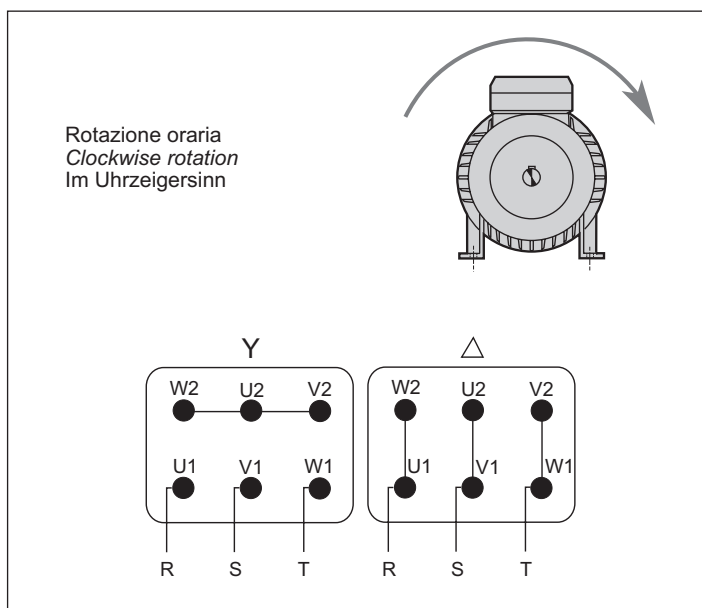
I motori VELA possono ruotare nei due sensi di marcia effettuando i collegamenti sottoriportati.

### 1.6 ROTATION DIRECTION

VELA motors can work in both rotation directions, as long as parts are connected according to the instructions provided.

### 1.6 DREHSINN

Die VELA Motoren können in beiden Drehrichtungen arbeiten, sofern die nachstehend angegebenen Anschlüsse ausgeführt werden.



### 1.7 LIVELLO DI PRESSIONE SONORA

La tab.1.3 riporta i valori medi (espressi in dB) del livello di pressione sonora LPA e potenza sonora LWA rilevati sulla scala di ponderazione (A), secondo le Norme IEC34-9 e riferiti ai motori funzionanti a 50 Hz senza carico applicato (sui valori riportati è ammessa una tolleranza + 3%).

Per motori funzionanti con frequenza a 60 Hz aumentare i valori di 5 dB(A)

### 1.7 NOISE PRESSURE

Tab.1.3 shows average values (in dB) of LPA noise pressure and LWA noise power, gathered according to the (A) weighting scale in compliance with IEC34-9 regulations for 50 Hz power motors with no applied loads (the values shown allow a + 3% tolerance margin).

Values must be increased by 5 dB(A) for 60 Hz power motors.

### 1.7 SCHALLDRUCKPEGEL

In Tab. 1.3 werden die gemäß IEC 34-9 ermittelten A-bewerteten Mittelwerte (in dB) des Schalldruckpegels LPA und der Schalleistung LWA für die mit 50 Hz betriebenen Motoren ohne Last angegeben (für die angegebenen Werte ist eine Toleranz von + 3 % zulässig).

Für Motoren mit einer Betriebsfrequenz von 60 Hz sind die Werte um 5 dB(A) zu erhöhen.

Tab. 1.3

			63	71	80	90S	90L	100L	100LA	100LB	112	132	160	180	200	225	250	280	315
2 P	LPA [dB]		54	56	57	62	62	65	—	—	65	71	73	74	75	79	80	82	86
	LWA [dB]		63	65	66	72	72	75	—	—	75	79	84	85	86	90	91	93	98
4 P	LPA [dB]		50	51	53	53	55	—	55	59	59	61	63	68	68	69	73	75	75
	LWA [dB]		58	60	62	63	65	—	65	69	69	72	74	79	79	80	84	86	87
6 P	LPA [dB]		47	48	52	52	52	—	—	—	52	60	68	64	64	67	67	67	67
	LWA [dB]		55	57	61	62	62	—	—	—	62	70	79	75	75	78	78	78	79

Per funzionamento a carico alla coppia nominale, i valori sopra riportati potranno subire gli incrementi massimi Δ LPA indicati nella tab.1.4.

Values could increase according to the maximum Δ LPA values indicated in tab.1.4 for motors working with loads to the rated torque.

Für den Betrieb unter Last mit dem Nennmoment können die oben angegebenen Werte maximale Steigerungen ΔLPA gemäß Tab. 1.4 erfahren.

Tab. 1.4

		0.12 < kW < 11	11 < kW < 37	37 < kW < 110	110 < kW < 200
2 P	Δ LPA [dB]	8	7	6	5
4 P	Δ LPA [dB]	7	6	5	4
6 P	Δ LPA [dB]	5	4	3	3

### 1.8 VIBRAZIONI

Tutti i motori VELA sono sottoposti ad equilibratura dinamica con mezza linguetta.

La tab.1.5 riporta i valori limite della velocità di vibrazione raccomandati dalle Norme IEC 34-14 in funzione dei tre gradi di intensità di vibrazione previsti:

- N : normale (standard)
- R : ridotta
- S : speciale

### 1.8 VIBRATIONS

All VELA motors undergo a half-spline dynamic balancing process.

Tab.1.5 shows the maximum vibration speed values recommended by IEC 34-14 regulations for grade:

- N : normal
- R : reduced
- S : special

### 1.8 VIBRATIONEN

Alle VELA Motoren sind dynamisch mit einer halben Passfeder ausgewuchtet.

In Tab. 1.5 sind die Grenzwerte der Vibrationsgeschwindigkeit angegeben, die gemäß IEC 34-14 in Abhängigkeit von den drei vorgesehenen Vibrationsstärkegraden festgelegt sind:

- N : Normalstärke (standard)
- R : Verringerte Stärke
- S : Sonderstärke

Tab. 1.5

		Limiti della velocità di vibrazione / Vibration speed limits / Grenzwerte der Vibrationsgeschwindigkeit [mm/s]		
Poli / Poles / Pole		Grandezze / Sizes / Größen		
		63 - 132	160 - 225	250 - 315
N	2 P	1.8	1.8	4.5
	4-6P	1.8	2.8	2.8
R	2 P	(a richiesta on request) Auf Anfrage	1.8	2.8
	4-6P		1.12	1.8
S	2 P		1.12	1.8
	4-6P		0.71	1.12



### 1.9 SCATOLA MORSETTI E INGRESSO CAVI

### 1.9 TERMINAL BOARD BOX AND CABLE SLOTS


### 1.9 KLEMMENKASTEN UND KABELINGANG

La tab.1.6 sottostante riassume i dati caratteristici dei morsetti e ingresso cavi relativi alle grandezze motore 63-315.

The table 1.6 below it sums up the characteristic data of the terminals and cables entrance of the motor sizes 63-315

In der nachstehenden Tab. 1.6 werden die Kenndaten der Anschlussklemmen und der Kabeleingänge für die Motorgrößen 63-315 angegeben.

Tab. 1.6

	Numero morsetti Number of terminals Anzahl Klemmen	Filettatura morsetti Terminal thread Klemmengewinde	Ingresso cavi Cable slots Kabeleingang	d1, d2
63	6	M4	PG13.5	14
71	6	M4	PG13.5	14
80	6	M4	PG16	16
90	6	M5	PG16	16
100	6	M5	PG21	21
112	6	M5	PG21	21
132	6	M5	PG21	21
160	6	M5	PG21	21
180	6	M8	PG29	30
200	6	M8	PG36	38
225	6	M8	PG36	38
250	6	M8	PG42	43
280	6	M10	PG42	43
315	6	M12	PG48	48

### 1.10 TENSIONE DI ALIMENTAZIONE E FREQUENZA

### 1.10 POWER VOLTAGE AND FREQUENCY

### 1.10 VERSORGUNGSSPANNUNG UND FREQUENZ

La tab.1.7 indica le tensioni di alimentazione e le frequenze standard applicabili alle varie grandezze di motori secondo le IEC 38. E' ammesso uno scostamento di  $\pm 10\%$  sul valore della tensione a 50 Hz.

Tab.1.7 shows power voltages and standard frequencies applicable to the different motor sizes. IEC 38 regulations allow a  $\pm 10\%$  tolerance on voltage values.


In Tab. 1.7 werden die Versorgungsspannungen und die Standardfrequenzen für die verschiedenen Motorgrößen gemäß IEC 38 angegeben. Es ist eine Abweichung von  $\pm 10\%$  vom Spannungswert bei 50 Hz zulässig.

Con gli scostamenti indicati, le norme ammettono una sovratemperatura di 10K.

Regulations also allow a 10K overheating within the tolerance described.

Mit den angegebenen Abweichungen gestatten die Normen eine Übertemperatur von 10K.

Tab. 1.7

	Tensione / Voltage / Spannung [V]		Indicazione designazione Designation indication Bezeichnung
	(50 Hz)	(60Hz)	
<b>63 - 112</b>	230/400	277/480	—
<b>132</b>	230/400	277/480	<b>A</b>
<b>132</b>	400 $\Delta$	480 $\Delta$	<b>B</b>
<b>&gt; 160</b>	400 $\Delta$	480 $\Delta$	—

**1.11 POTENZA**

Le potenze nominali attribuite ai motori sono riferite ad una temperatura ambiente  $T_0$  di 40 °C e ad un'altitudine fino a 1000 m s.l.m.  
Per temperature oltre i 40 °C e altitudini superiori ai 1000 m fare riferimento alle tab.1.8 e 1.9 declassando la potenza  $P_N$  delle percentuali indicate.

**1.11 POWER**

*The motor ratings described refer to a  $T_0$  room temperature of 40 °C and to an altitude up to 1000 Mt above sea level.  
For temperatures over 40 °C and altitudes over 1000 Mt, refer to tab.1.8 and 1.9, decreasing  $P_N$  power by the indicated percentages.*

**1.11 LEISTUNG**

Die Nennleistungen der Motoren beziehen sich auf eine Umgebungstemperatur  $T_0$  von 40°C und eine Höhenlage bis 1.000 m ü.M.  
Für Temperaturen über 40°C und Höhenlagen über 1.000 m siehe die angegebenen Prozentwerte in Tab. 1.8 und Tab. 1.9, die von der Nennleistung abzuziehen sind.

Tab. 1.8

$T_0$ °C	40	45	50	55	60
$P_N$ %	100	96	92	87	82

Tab. 1.9

altitudine / altitude / Höhenlage [m]	1000	1500	2000	2500	3000	3500	4000	4300
---------------------------------------	------	------	------	------	------	------	------	------

**1.12 RENDIMENTO E FATTORE DI POTENZA**

Nelle tabelle dei dati tecnici dei motori sono riportati i valori del rendimento ( $\eta$ ) e del fattore di potenza ( $\cos\phi$ ) di potenza riferiti alla coppia nominale  $M$ .  
Se la coppia nominale è utilizzata parzialmente, è possibile dalle tab.1.10 e 1.11 risalire ai valori corretti (interpolando dove necessario).

**1.12 EFFICIENCY AND POWER FACTOR**

*Motor's data tables include efficiency ( $\eta$ ) and power factor ( $\eta$ ) values referred to the  $M$  rated torque.  
If the rated torque is used only partially, the correct values can be calculated using tab.1.10 and 1.11 (interpolating values if necessary).*

**1.12 AUSBRINGUNG UND LEISTUNGSFAKTOR**

In den Tabellen mit den technischen Daten der Motoren sind die Ausbringung ( $\eta$ ) und der Leistungsfaktor ( $\cos\phi$ ) bezogen auf das Nennmoment  $M$  angegeben.  
Wenn das Nennmoment anteilig verwendet wird, können mittels Tab. 1.10 und 1.11 die richtigen Werte ermittelt werden (durch Interpolation, sofern erforderlich).

Tab. 1.10

	<b>M</b>			
	50%	75%	100%	125%
$\eta$ %	94.5	96.0	96.0	95.0
	93.5	95.0	95.0	94.0
	93.0	94.0	94.0	93.0
	92.5	93.0	93.0	92.0
	92.0	92.5	92.0	91.0
	91.0	91.5	91.0	90.0
	89.0	90.0	90.0	89.0
	88.0	89.0	89.0	88.0
	87.0	88.0	88.0	87.0
	86.5	87.5	87.0	86.0
	85.5	86.5	86.0	85.0
	83.5	85.5	85.0	84.0
	82.5	84.5	84.0	83.0
	81.5	83.0	83.0	81.5
	80.5	82.0	82.0	80.5
	79.0	81.0	81.0	79.0
	78.0	80.0	80.0	78.0
	77.0	79.0	79.0	76.5
	76.0	78.0	78.0	75.5
	75.0	77.0	77.0	75.0
	73.5	75.5	76.0	74.5
	63.5	68.5	69.0	67.5
	63.0	67.5	68.0	66.0
	62.0	66.5	67.0	65.0
	61.0	65.0	66.0	64.0
	60.0	64.0	65.0	63.0
	59.0	63.0	64.0	62.0
	57.0	62.0	63.0	61.0
	56.0	60.5	62.0	60.5
	55.0	59.5	61.0	59.5
	53.5	58.5	60.0	58.5
	51.5	57.5	59.0	58.0
50.0	56.5	58.0	57.0	
49.0	55.0	57.0	56.0	
46.0	53.0	56.0	55.0	
45.0	52.0	55.0	53.0	

Tab. 1.11

	<b>M</b>			
	50%	75%	100%	125%
$\cos\phi$	0.88	0.90	0.92	0.92
	0.87	0.89	0.91	0.91
	0.84	0.88	0.90	0.90
	0.80	0.86	0.89	0.89
	0.78	0.85	0.88	0.89
	0.76	0.83	0.87	0.88
	0.74	0.82	0.86	0.87
	0.73	0.81	0.85	0.86
	0.71	0.80	0.84	0.86
	0.70	0.79	0.83	0.84
	0.68	0.78	0.82	0.83
	0.66	0.71	0.81	0.82
	0.65	0.73	0.80	0.81
	0.62	0.74	0.79	0.80
	0.60	0.72	0.78	0.80
	0.58	0.70	0.77	0.80
	0.57	0.69	0.76	0.80
	0.56	0.69	0.75	0.80
	0.54	0.67	0.73	0.78
	0.52	0.65	0.72	0.77
0.49	0.63	0.71	0.77	
0.47	0.61	0.70	0.76	

### 1.13 ISOLAMENTO

Tutti i motori sono costruiti nella versione standard con isolamento degli avvolgimenti in classe F.

In caso di funzionamento in ambienti con elevato tasso di umidità, su richiesta, è possibile eseguire un processo di tropicalizzazione sugli avvolgimenti.

### 1.13 INSULATION RATING

All the motors are designed in standard version with class F winding insulation.

If the motors are installed in high umidity areas the windings may be tropicalized upon request.

### 1.13 ISOLIERUNG

Alle Motoren sind in der Standardversion mit Wicklungen in der Isolierstoffklasse F ausgeführt.

Für den Einsatz in Umgebungen mit einer hohen Luftfeuchtigkeit ist auf Anfrage die tropfenfeste Ausführung der Wicklungen möglich.

### 1.14 TIPO DI SERVIZIO

I dati tecnici del presente catalogo si riferiscono al servizio continuo S1, definito secondo normative come funzionamento a carico costante, mantenuto per il tempo necessario per permettere al motore di raggiungere l'equilibrio termico.

### 1.14 SERVICE TYPE

Engineering data included in this catalogue refer to the S1 continuous service, defined by the current regulations as constant load operation maintained for the time required by the motor to reach thermal balance.

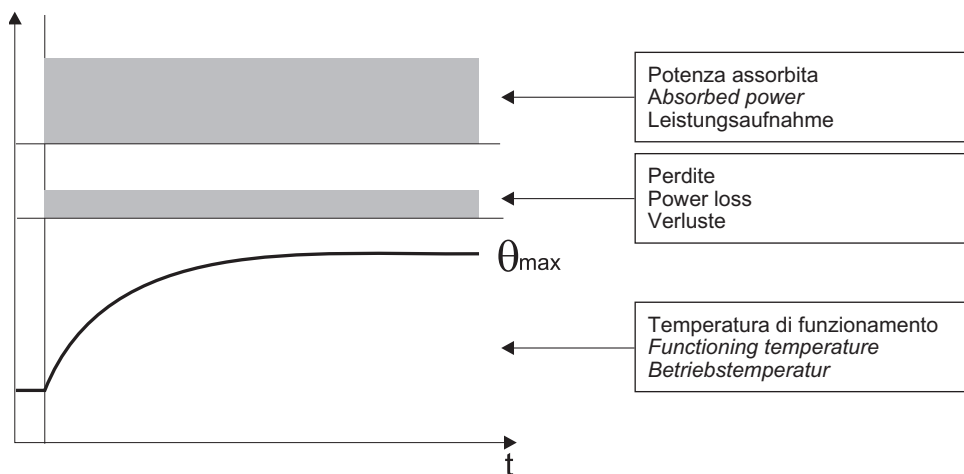
### 1.14 BETRIEBSART

Für die im Katalog angegebenen technischen Daten beziehen sich auf den Dauerbetrieb S1, der nach Norm als Betrieb des Motors mit konstanter Last über einen unbestimmten Zeitraum definiert ist, der für die Erreichung des Temperaturgleichgewichts ausreichend ist.

S1 - S9: pag. D10

S1 - S9: page D10

S1 - S9: Seite D10



### 1.15 NORME DI RIFERIMENTO


### 1.15 REFERENCE STANDARD

### 1.15 BEZUGSNORMEN


Tab. 1.12

Descrizione	Description	Beschreibung	IEC
Macchine elettriche rotanti Prescrizioni generali	Rotating electrical machines General requirements	Drehende elektrische Maschinen Allgemeine Vorschriften	IEC 34-1
Macchine elettriche rotanti Dimensioni e potenze	Rotating electrical machines construction dimension and power	Drehende elektrische Maschinen Abmessungen und Leistungen Einteilung der Schutzarten	IEC 72
Macchine elettriche rotanti Classificazione dei gradi di protezione	Rotating electrical machines classification of protection degrees	Definition der Kühlverfahren für drehende elektrische Maschinen	IEC 34-5
Definizione dei metodi di raffreddamento delle macchine elettriche rotanti	Cooling methods of rotating electrical machines	Bezeichnung der Bauformen von drehenden elektrischen Maschinen	IEC 34-6
Definizione delle forme costruttive delle macchine elettriche rotanti	Classification of types of constructions of rotating electrical machines	Anschlussbezeichnungen und Drehsinn von drehenden elektrischen Maschinen	IEC 34-7
Definizione dei terminali e del senso di rotazione delle macchine elettriche rotanti	Classification of terminal marking and direction of rotating electrical machines	Geräuschgrenzwerte von drehenden elektrischen Maschinen	IEC 34-8
Limiti di rumorosità delle macchine elettriche rotanti	Noise limits of rotating electrical machines	Schwingungen von drehenden elektrischen Maschinen	IEC 34-9
Grado di vibrazione delle macchine elettriche rotanti	Vibration degree of rotating electrical machines	Drehende elektrische Maschinen	IEC 34-14
Macchine elettriche rotanti Potenza uscita, tensione e frequenza	REM power, voltage and frequency	Ausgangsleistung, Spannung und Frequenz	IEC 38



**2 poli / 2 poles / 2 polig**

Tipo Type Typ	P <sub>n</sub>		n <sub>n</sub> [min <sup>-1</sup> ]	C <sub>n</sub> [Nm]	I <sub>n</sub> (400V) [A]	η %	cos φ	I <sub>a</sub> I <sub>n</sub>	C <sub>a</sub> C <sub>n</sub>	C <sub>max</sub> C <sub>n</sub>	J [Kg m <sup>2</sup> ]	
	[kW]	[HP]										
56A2	0.09	0.12	2700	0.32	0.36	59	0.75	2.8	2	2.2	0.00012	3.0
56B2	0.12	0.16	2700	0.45	0.47	60	0.75	3	2	2.3	0.00015	3.0
63A2	0.18	0.25	2730	0.63	0.54	68.0	0.78	5.0	2.2	2.2	0.00030	3.6
63B2	0.25	0.35	2730	0.87	0.73	69.0	0.79	5.0	2.2	2.2	0.00050	3.9
71A2	0.37	0.50	2760	1.30	0.94	72.0	0.86	5.0	1.8	2.2	0.00073	4.9
71B2	0.55	0.75	2760	1.90	1.36	75.0	0.85	5.0	1.8	2.2	0.00092	5.7
80A2	0.75	1.00	2820	2.50	1.83	78.5	0.83	6.0	1.6	2.2	0.00095	8.9
80B2	1.10	1.50	2800	3.80	2.6	79.0	0.83	6.0	1.6	2.2	0.00110	9.7
90S2	1.50	2.00	2850	5.00	3.3	82.5	0.85	7.0	1.8	3.4	0.00180	14.4
90L2	2.20	3.00	2850	7.40	4.40	83.5	0.87	7.0	1.8	3.0	0.00210	16.5
100L2	3.00	4.00	2850	10.1	6.1	84.5	0.88	7.0	1.6	2.2	0.00360	26.1
112M2	4.00	5.50	2850	13.4	7.60	87.0	0.88	7.5	1.6	2.2	0.00590	29.8
112L2	5.50	7.50	2850	18.4	10.3	88.0	0.88	7.5	1.6	2.4	0.01000	35.2
132 SA2	5.50	7.50	2910	18.2	10.9	86.0	0.85	7.5	2.0	2.8	0.0126	37.5
132 M2	7.50	10.0	2910	24.7	14.4	87.5	0.87	7.5	2.2	3.0	0.0236	52.0
160MA2	11.0	15.0	2910	36.0	20.0	90.0	0.9	7.5	2.4	3.4	0.024	81.0
160MB2	15.0	20.0	2900	49.0	27	90.0	0.90	7.5	2.4	3.4	0.039	91.0
160L2	18.5	25.0	2920	60.0	33.2	90.5	0.89	7.5	2.8	3.4	0.045	138
180M2	22.0	30.0	2925	72.0	39.4	90.5	0.89	7.3	2.6	3.2	0.063	170
200LA2	30.0	40.0	2940	98.0	53.0	91.5	0.89	7.0	2.4	3.0	0.076	185
200LB2K	37.0	50.0	2940	120	64	93.0	0.90	7.2	2.4	3.2	0.13	255
225M2K	45.0	60.0	2940	146	78	93.0	0.9	7.2	2.5	3.2	0.15	275
250M2K	55.0	75.0	2940	178	93.0	93.5	0.92	7.5	2.3	3.3	0.21	340
280S2K	75.0	100	2955	242	127	93.2	0.91	7.5	2.0	2.9	0.47	485
280M2K	90.0	125	2955	291	152	93.1	0.92	6.9	1.7	2.9	0.52	515
315S2	110	150	2960	355	183	94.1	0.92	7.2	2.1	3.4	0.85	720
315M2K	132	180	2960	426	219	94.5	0.92	7.5	2.3	3.4	1.02	770
315LA2	160	220	2970	514	265	94.5	0.92	7.2	1.8	2.8	1.42	970
315LB2	200	270	2975	642	322	95.0	0.94	7.2	1.8	2.8	1.78	1110


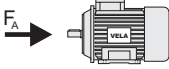
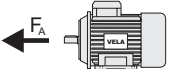


## 4 poli / 4 poles / 4 polig

Tipo Type Typ	Pn		n <sub>n</sub> [min <sup>-1</sup> ]	Cn [Nm]	In (400V) [A]	η %	cos φ	I <sub>a</sub> I <sub>n</sub>	C <sub>a</sub> C <sub>n</sub>	C <sub>max</sub> C <sub>n</sub>	J [Kg m <sup>2</sup> ]	
	[kW]	[HP]										
56B4	0.09	0.12	1350	0.65	0.44	56.0	0.6	2.3	1.8	2.0	0.00050	3.0
63A4	0.12	0.16	1350	0.85	0.46	63.0	0.66	5.0	2.3	2.2	0.00070	3.6
63B4	0.18	0.25	1350	1.30	0.66	64.0	0.68	5.0	2.3	2.2	0.00080	3.9
71A4	0.25	0.35	1370	1.70	1.1	68.0	0.67	5.0	1.8	2.2	0.00110	5.0
71B4	0.37	0.50	1370	2.60	1.3	68.0	0.70	5.0	1.8	2.2	0.00140	5.7
80A4	0.55	0.75	1360	3.90	1.72	71.0	0.73	5.0	1.8	2.4	0.00130	8.3
80B4	0.75	1.00	1350	5.30	2.14	72.0	0.75	5.0	1.6	2.6	0.00150	9.6
90S4	1.10	1.50	1395	7.50	2.89	76.7	0.79	6.0	1.8	2.6	0.00340	12.2
90L4	1.50	2.00	1395	10.3	3.61	78.5	0.83	6.0	1.8	2.6	0.00360	15.4
100LA4	2.20	3.00	1395	15.1	5.23	81.0	0.81	6.5	1.6	2.4	0.00530	24.6
100LB4	3.00	4.00	1410	20.5	6.8	82.0	0.84	7.0	1.6	2.6	0.00580	26.6
112M4	4.00	5.50	1410	27.1	8.10	85.0	0.84	6.0	1.6	2.4	0.01050	33.6
112N4	5.50	7.50	1410	37.2	12.10	82.0	0.80	6.0	2.3	2.6	0.01300	34.5
132S4	5.50	7.50	1455	36.6	11.4	85.0	0.82	7.5	2.0	2.5	0.03500	52.0
132M4	7.50	10.0	1450	50.3	15.1	86.4	0.83	7.5	2.4	2.9	0.03900	65.0
160M4	11.0	15.0	1450	73.0	21.0	88.5	0.86	7.4	2.4	3	0.045	87.0
160L4	15.0	20.0	1455	99.0	22.1	89.5	0.86	6.1	2.3	2.6	0.075	127
180M4	18.5	25.0	1455	121	34.5	90.0	0.86	6.2	2.3	2.5	0.087	145
180L4	22.0	30.0	1450	145	41.8	90.5	0.84	6.1	2.3	2.2	0.16	152
200L4	30.0	40.0	1455	196	55.0	91.0	0.86	6.8	2.5	2.6	0.20	190
225S4K	37.0	50.0	1470	241	68.4	92.2	0.85	6.7	2.6	2.6	0.27	260
225M4K	45.0	60.0	1470	293	83.0	92.5	0.85	6.9	2.5	2.5	0.32	280
250M4K	55.0	75.0	1475	357	99.4	93.3	0.86	6.8	2.4	2.4	0.50	350
280S4K	75.0	100	1480	484	134	94.0	0.86	7.2	2.1	2.3	1.00	495
280M4K	90.0	125	1485	578	156	94.3	0.88	7.2	2.3	2.3	1.20	545
315S4	110	150	1485	707	191	95.4	0.87	6.8	2.3	2.8	2.19	790
315M4	132	180	1490	848	226	95.9	0.88	7.0	2.4	2.8	2.70	885
315LA4	160	220	1485	1028	272	96.0	0.89	6.8	1.9	2.2	3.57	1110
315LB4	200	270	1485	1285	339	96.0	0.89	6.8	1.9	2.0	3.97	1150

### 6 poli / 6 poles / 6 polig

	P <sub>n</sub>		n <sub>n</sub> [min <sup>-1</sup> ]	C <sub>n</sub> [Nm]	I <sub>n</sub> (400V) [A]	η %	cos φ	I <sub>a</sub> I <sub>n</sub>	C <sub>a</sub> C <sub>n</sub>	C <sub>max</sub> C <sub>n</sub>	J [Kg m <sup>2</sup> ]	 Kg
	[kW]	[HP]										
71A6	0.18	0.25	885	1.90	0.94	56.0	0.62	3.7	2.2	2.2	0.00200	4.6
71B6	0.25	0.33	885	2.70	1.23	59.0	0.62	3.7	2.2	2.2	0.00210	5.4
80A6	0.37	0.50	915	3.90	1.47	65.0	0.66	4.5	2.2	2.2	0.00230	8.6
80B6	0.55	0.75	915	5.70	1.9	68.5	0.70	4.5	2.2	2.2	0.00250	10.1
90S6	0.75	1.00	920	7.80	2.49	70.5	0.71	4.5	2.3	2.3	0.00340	13.3
90L6	1.10	1.50	920	11.4	3.24	74.5	0.74	4.0	2.4	2.4	0.00490	16.5
100L6	1.50	2.20	925	15.5	4.00	76.0	0.72	6.0	2.2	2.2	0.00710	25.8
112M6	2.20	3.00	945	22.2	5.30	81.0	0.74	6.0	2.1	2.1	0.01230	30.9
132S6	3.00	4.00	950	30.2	6.7	81.0	0.79	5.5	2.2	2.8	0.02200	45.5
132MA6	4.00	5.50	955	39.8	8.9	82.0	0.79	5.5	2.0	2.5	0.05200	52.0
132MB6	5.50	7.50	950	54.7	11.8	84.0	0.80	6.0	2.5	2.5	0.05900	61.0
160M6	7.50	10.0	960	75.0	15.5	87.0	0.80	6.7	2.3	3.0	0.067	86.0
160L6	11.0	15.0	965	108	22.5	88.5	0.82	6.5	2.0	2.8	0.110	124
180L6	15.0	20.0	970	147	29.5	90.5	0.83	7.0	2.3	3.0	0.150	155
200LA6	18.5	25.0	975	181	34.7	90.0	0.86	6.9	2.0	2.8	0.240	190
200LB6K	22.0	30.0	975	215	42.3	90.0	0.83	6.0	2.2	2.3	0.410	250
225M6K	30.0	40.0	975	294	57.0	90.0	0.84	6.0	2.1	2.4	0.460	270
250M6K	37.0	50.0	980	360	69.9	91.0	0.84	6.3	2.3	2.5	0.650	335
280S6K	45.0	60.0	985	438	83.2	92.5	0.84	6.5	2.2	2.3	1.200	440
280M6K	55.0	75.0	980	536	101	92.5	0.85	6.1	2.2	2.3	1.300	460
315S6	75.0	100	990	727	135	94.7	0.85	6.3	2.2	2.4	3.040	745
315M6	90.0	125	990	872	162	94.7	0.85	6.3	2.0	2.2	3.360	780
315LA6	110	150	990	1066	190	95.0	0.88	6.7	1.6	2.4	4.540	960
315LB6	132	180	985	1279	219	95.2	0.91	7.0	1.7	2.4	5.130	1010

**1.17 CARICHI RADIALI E ASSIALI    1.17 RADIAL AND AXIAL LOADS    1.17 RADIAL- UND AXIALLASTEN**

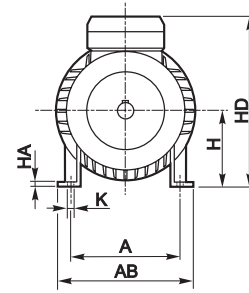
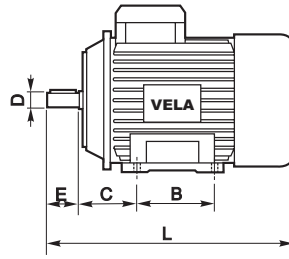
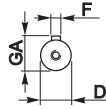
	Poli Poles	Carico assiale max. $F_A$ / Maximum axial load $F_A$ / Axiallast max. $F_A$								$F_R$ max
		Montaggio orizzontale Horizontal assembling Horizontale Einbaulage				Montaggio verticale Vertical assembling Vertikale Einbaulage				
										
		$F_R = 0$	$F_R$ max	$F_R = 0$	$F_R$ max	$F_R = 0$	$F_R$ max	$F_R = 0$	$F_R$ max	
<b>63</b>	2	140	110	140	110	145	115	130	95	300
	4	290	190	290	190	300	195	280	160	350
	6	380	270	380	270	370	275	360	240	400
<b>71</b>	2	270	190	270	190	280	200	250	170	380
	4	360	260	360	260	370	270	340	240	400
	6	450	330	450	330	460	340	430	310	420
<b>80</b>	2	620	450	620	450	640	470	590	420	500
	4	810	590	810	590	830	610	780	560	590
	6	950	690	950	690	980	720	910	650	670
<b>90</b>	2	670	490	670	490	700	520	630	450	540
	4	870	640	870	640	910	680	820	590	730
	6	1080	790	1080	790	1130	840	1020	730	830
<b>100</b>	2	930	680	930	680	980	730	870	620	850
	4	1150	840	1150	840	1210	900	1080	770	1070
	6	1440	1050	1440	1050	1520	1130	1360	970	1230
<b>112</b>	2	920	670	920	670	980	730	850	600	870
	4	1190	870	1190	870	1270	850	1100	780	1080
	6	1450	1060	1450	1060	1540	1150	1350	960	1250
<b>132</b>	2	1250	820	1250	820	1350	830	1150	810	1200
	4	1500	1050	1500	1050	1600	1100	1400	950	1600
	6	1720	1350	1720	1350	1820	1450	1600	1300	1950
<b>160</b>	2	1450	1150	1450	520	1550	1300	1400	380	1940
	4	1750	1350	1750	680	2050	1600	1850	470	2450
	6	2200	1750	2200	800	2450	1850	2200	540	2810
<b>180</b>	2	2030	780	2030	780	2250	990	1920	630	1570
	4	2480	1080	2480	1080	3000	1080	2510	590	2270
	6	2280	1300	2280	1300	3500	1300	2950	750	2600
<b>200</b>	2	2030	780	2030	780	2250	990	1920	630	1570
	4	1670	1070	1670	1070	2120	1340	1420	640	3600
	6	2080	1360	2080	1360	2560	1600	1750	790	3850
<b>225</b>	2	1340	940	1340	940	1560	1040	1060	540	3380
	4	1670	1070	1670	1070	2120	1340	1420	640	4390
	6	2080	1360	2080	1360	2560	1600	1750	790	5060
<b>250</b>	2	1500	1020	1500	1020	1720	1190	1080	550	3870
	4	1860	1220	1860	1220	2350	1490	1470	610	4960
	6	2240	1370	2240	1370	2800	1760	1790	750	5750
<b>280</b>	2	3210	2760	3210	2760	3570	3000	2550	1980	4890
	4	4280	3590	4280	3590	4870	3970	3440	2540	6540
	6	5000	4180	5000	4180	5870	4760	4470	3360	7560
<b>315S-M</b>	2	3050	2550	3050	2550	3550	2650	2090	1190	4890
	4	3850	3150	3850	3150	4900	3750	2720	1570	6250
	6	4600	3750	4600	3750	6000	4600	3770	2370	7210
<b>315L</b>	2	3400	2700	3400	2700	4100	3200	1970	1070	5420
	4	4300	3600	4300	3600	5450	4350	2650	1550	7410
	6	5100	4150	5100	4150	6450	5150	3570	2270	8570

1.18 DIMENSIONI

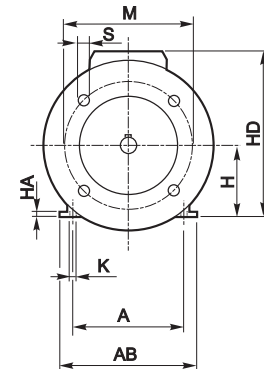
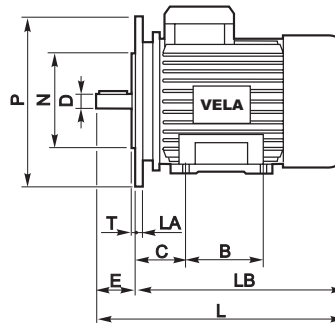
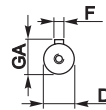
1.18 DIMENSIONS


1.18 ABMESSUNGEN

**B3**



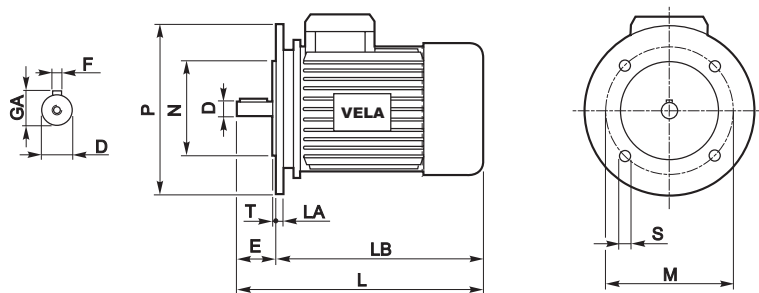
**B3/B5**



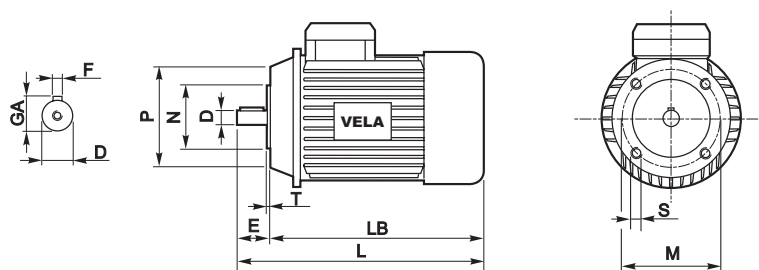
	B3 - B3/B5						B3							B3/B5						
	C	D	E	F	GA	L	AB	A	B	H	HA	HD	K	S	LA	LB	M	N	P	T
63	40	11	23	4	12.5	210	117	90	80	63	7	148	7	10	10	187	115	95	140	3.0
71	45	14	30	5	16.0	234	135	113	90	71	7	172	7	10	10	204	130	110	160	3.5
80	50	19	40	6	21.5	272	150	126	100	80	9	197	10	12	10	232	165	130	200	3.5
90S	56	24	50	8	27.0	296	165	140	100	90	10	214	10	12	10	246	165	130	200	3.5
90L	56	24	50	8	27.0	320	165	140	125	90	10	214	10	12	10	270	165	130	200	3.5
100	63	28	60	8	31.0	347	194	160	140	100	12	243	12	15	14	287	215	180	250	4.0
112	70	28	60	8	31.0	391	230	190	140	112	12	260	12	15	14	331	215	180	250	4.0
132S	89	38	80	10	41.0	440	254	215	140	132	13	305	12	15	14	360	265	230	300	4.0
132M	89	38	80	10	41.0	485	254	215	178	132	13	305	12	15	14	405	265	230	300	4.0
160M	108	42	110	12	45.0	630	292	254	210	160	18	347	15	19	16	520	300	250	350	5.0
160L	108	42	110	12	45.0	630	292	254	254	160	18	347	15	19	16	520	300	250	350	5.0
180M	121	48	110	14	51.5	700	320	279	241	180	20	422	15	19	13	550	300	250	350	5.0
180L	121	48	110	14	51.5	700	320	279	279	180	20	422	15	19	13	550	300	250	350	5.0
200LA	121	55	110	16	59.0	670	368	318	305	200	25	460	19	19	13	550	350	300	400	5.0
200L	133	55	110	16	59.0	670	368	318	305	200	25	460	19	19	15	560	350	300	400	5.0
200LB	133	55	110	16	59.0	781	395	318	305	200	25	490	19	19	15	671	350	300	400	5.0
225S	149	60	140	18	64.0	811	425	356	286	225	30	515	19	19	19	671	400	350	450	5.0
225M2	133	55	110	18	59.0	811	395	318	311	225	30	515	19	19	19	701	400	350	450	5.0
225M4-6	149	60	140	18	64.0	811	425	356	311	225	30	515	19	19	19	671	400	350	450	5.0
250M2	168	60	140	18	64.0	865	480	406	349	250	35	560	24	19	19	725	500	450	550	5.0
250M4-6	168	65	140	18	69.0	865	480	406	349	250	35	560	24	19	19	725	500	450	550	5.0
280S2	190	65	140	18	69.0	935	560	457	368	280	35	660	24	19	18	795	500	450	550	5.0
280S4-6	190	75	140	20	79.5	935	560	457	368	280	35	660	24	19	18	795	500	450	550	5.0
280M2	190	65	140	18	69.0	985	560	457	419	280	35	660	24	19	18	845	500	450	550	5.0
280M4-6	190	75	140	20	79.5	985	560	457	419	280	35	660	24	19	18	845	500	450	550	5.0
315S2	216	65	140	18	69	1080	608	508	406	315	40	695	28	24	22	940	600	550	660	6.0
315M2	216	65	140	18	69	1150	608	508	457	315	40	695	28	24	22	1010	600	550	660	6.0
315S4-6	216	80	170	22	85	1110	608	508	406	315	40	695	28	24	22	940	600	550	660	6.0
315M4-6	216	80	170	22	85	1180	608	508	457	315	40	695	28	24	22	1010	600	550	660	6.0
315LA2	216	65	140	18	69	1160	608	508	508	315	40	765	28	24	22	1020	600	550	660	6.0
315LB2	216	65	140	18	69	1260	608	508	508	315	40	765	28	24	22	1120	600	550	660	6.0
315L4	216	80	170	22	85	1290	608	508	508	315	40	765	28	24	22	1120	600	550	660	6.0
315L6	216	80	170	22	85	1190	608	508	508	315	40	765	28	24	22	1020	600	550	660	6.0




### B5



### B14



	B5 - B14					B5							B14						
	D	E	F	GA	L	S	LA	LB	M	N	P	T	S	LB	M	N	P	T	
63	11	23	4	12.5	210	10	10	187	115	95	140	3.0	M5	187	75	60	90	2.5	
71	14	30	5	16.0	234	10	10	204	130	110	160	3.5	M6	204	85	70	105	2.5	
80	19	40	6	21.5	272	12	10	232	165	130	200	3.5	M6	232	100	80	120	3.0	
90S	24	50	8	27.0	296	12	10	246	165	130	200	3.5	M8	246	115	95	140	3.0	
90L	24	50	8	27.0	320	12	10	270	165	130	200	3.5	M8	270	115	95	140	3.0	
100	28	60	8	31.0	347	15	14	287	215	180	250	4.0	M8	287	130	110	160	3.5	
112	28	60	8	31.0	391	15	14	331	215	180	250	4.0	M8	331	130	110	160	3.5	
132S	38	80	10	41.0	440	15	14	360	265	230	300	4.0							
132M	38	80	10	41.0	485	15	14	405	265	230	300	4.0							
160M	42	110	12	45.0	630	19	16	520	300	250	350	5.0							
160L	42	110	12	45.0	630	19	16	520	300	250	350	5.0							
180M	48	110	14	51.5	670	19	13	550	300	250	350	5.0							
180L	48	110	14	51.5	670	19	13	550	300	250	350	5.0							
200LA	55	110	16	59.0	670	19	13	550	350	300	400	5.0							
200L	55	110	16	59.0	670	19	15	560	350	300	400	5.0							
200LB	55	110	16	59.0	781	19	15	671	350	300	400	5.0							
225S	60	140	18	64.0	811	19	19	671	400	350	450	5.0							
225M2	55	110	16	59.0	811	19	19	701	400	350	450	5.0							
225M4-6	60	140	8	64.0	811	19	19	671	400	350	450	5.0							
250M2	60	140	18	64.0	865	19	19	725	500	450	550	5.0							
250M4-6	65	140	18	69.0	865	19	19	725	500	450	550	5.0							
280S2	65	140	18	69.0	935	19	18	795	500	450	550	5.0							
280S4-6	75	140	20	79.5	935	19	18	795	500	450	550	5.0							
280M2	65	140	18	69.0	985	19	18	845	500	450	550	5.0							
280M4-6	75	140	20	79.5	985	19	18	845	500	450	550	5.0							
315S2	65	140	18	69	1080	24	22	940	600	550	660	6.0							
315M2	65	140	18	69	1150	24	22	1010	600	550	660	6.0							
315S4-6	80	170	22	85	1110	24	22	940	600	550	660	6.0							
315M4-6	80	170	22	85	1180	24	22	1010	600	550	660	6.0							
315LA2	65	140	18	69	1160	24	22	1020	600	550	660	6.0							
315LB2	65	140	18	69	1260	24	22	1120	600	550	660	6.0							
315L4	80	170	22	85	1290	24	22	1120	600	550	660	6.0							
315L6	80	170	22	85	1190	24	22	1020	600	550	660	6.0							



## 1.0 INVERTER / INVERTER / FREQUENZUMRICHTER

				kW	Pag. Page Seite
serie <b>A</b>	Controllo semplice per piccole potenze con rete di alimentazione monofase	<i>Single phase supply for low power drive with simple control</i>	Einfache Steuerung für niedrige Antriebsleistungen mit einphasigem Stromversorgungsnetz	<b>0.25 – 1.1</b>	C3
serie <b>R</b>	Controllo vettoriale per basse potenze con alimentazione monofase / trifase	<i>Single phase / three phase low power vector control</i>	Vettoriale Steuerung für niedrige Antriebsleistungen mit einphasiger / dreiphasiger Einspeisung	<b>0.37 – 2.2</b>	C7
serie <b>V</b>	Controllo vettoriale per medie potenze	<i>Medium power drive vector control</i>	Vettoriale Steuerung für mittlere Antriebsleistungen	<b>3 – 18.5</b>	C11
serie <b>T</b>	Controllo vettoriale per alte potenze	<i>High power drive vector control</i>	Vettoriale Steuerung für hohe Antriebsleistungen	<b>22 – 200</b>	C15

serie  
**A**serie  
**R**serie  
**V**serie  
**T**

### 1.1 CODIFICA STM DRIVE

### 1.1 STM DRIVE CODE

### 1.1 STM DRIVE CODE

Potenze Range Leistungen [kW]	Serie Drive Series Antrieb - Serie	Tensione di ingresso Voltage supply Eingangsspannung		Potenza Power Leistung	Software	I/O	Filtro EMC EMC Filter EMC-Filter	Freno Brake Unit Bremse
<b>0.25÷1.1</b>	<b>A</b>	X	X	000	X	X	X	—
<b>0.37÷2.2</b>	<b>R</b>	X	X	000	X	X	X	X
<b>3÷18.5</b>	<b>V</b>	—	—	000	X	X	X	—
<b>22÷200</b>	<b>T</b>	—	—	000	X	X	X	X

<p>— campi non utilizzati field not used Feld nicht verwendet</p>	<p><b>2</b> = 220 V –15% 240 V +10%</p> <p><b>4</b> = 380 V –15% 460 V +10%</p>	<p><b>M</b> monofase single phase einphasig</p> <p><b>T</b> trifase three phase dreiphasig</p>	<p><b>002</b> = 250 W <b>004</b> = 370 W <b>005</b> = 550 W <b>008</b> = 750 W <b>011</b> = 1.1 kW <b>015</b> = 1.5 kW <b>022</b> = 2.2 kW <b>030</b> = 3.0 kW <b>040</b> = 4.0 kW <b>055</b> = 5,5 kW <b>075</b> = 7.5 kW <b>110</b> = 11 kW <b>150</b> = 15 kW <b>185</b> = 18.5 kW <b>220</b> ...</p>	<p><b>X</b> = Standard</p>	<p>Vedi dettaglio per la serie specifica</p> <p>See detail for series</p> <p>Siehe Einzelheit für serie</p>	<p><b>X</b> assente absent nicht vorhanden</p> <p><b>A</b> classe A A class A Klasse (Livello industriale Industrial level Industrielles Niveau)</p> <p><b>B</b> classe B B class B Klasse (Livello nazionale Domestic level Nationales Niveau)</p>	<p><b>X</b> non presente not present nicht Geschen</p> <p><b>B</b> installato on board An bord</p>
---	---	--	--	----------------------------	---	---	--



Serie Drive Series Antrieb - Serie	Tensione di ingresso Voltage supply Eingangsspannung		Potenza Power Leistung	Software	I/O	Filtro EMC EMC Filter EMC-Filter
<b>A</b>	<b>2</b>	<b>M</b>	<b>008</b>	<b>X</b>	<b>Y</b>	<b>A</b>

Inverter Serie A, alimentazione a 230 V monofase, potenza nominale 750 W, software standard, I/O standard (Y=4 ingressi digitali,...), filtro integrato in classe A.

*A SERIES Inverter, supply 230Vac single phase, nominal power 750W, software standard, I/O standard, integrated filter A class.*

A Serie Inverter, Spannung 230 einphasig, Nennleistung 750W, software Standard, I/O Standard, integriert Filter A klasse.



Serie Drive Series Antrieb - Serie	Tensione di ingresso Voltage supply Eingangsspannung		Potenza Power Leistung	Software	I/O	Filtro EMC EMC Filter EMC-Filter	Freno Brake Unit Bremse
<b>R</b>	<b>4</b>	<b>T</b>	<b>022</b>	<b>X</b>	<b>E</b>	<b>A</b>	<b>B</b>

Inverter Serie R, alimentazione a 400 V Trifase, potenza nominale 2.2 kW, software standard, I/O opzionale montata per encoder, filtro integrato in classe A, Brake Unit presente.

*R SERIES inverter, supply 400Vac three phase, nominal power 2.2 kW, software standard, I/O option for encoder connection, integrated filter class A, Brake Unit.*

R Serie Inverter, Spannung 400 dreiphasig, Nennleistung 2.2 kW, software Standard, I/O encoder Option, integrato Filter A klasse, Bremseinheit.



Serie Drive Series Antrieb - Serie	Potenza Power Leistung	Software	I/O	Filtro EMC EMC Filter EMC-Filter
<b>V</b>	<b>075</b>	<b>X</b>	<b>X</b>	<b>A</b>

Inverter Serie V, alimentazione a 230 V trifase o 400 V trifase, potenza nominale 7.5 kW - 400 V, software standard, I/O standard, filtro integrato in classe A, Brake Unit sempre presente.

*V SERIES inverter, supply voltage 230Vac or 400Vac, nominal power 7.5 kW - 400Vac, software standard, I/O standard, integrated EMC filter A class..*

V Serie Inverter, Spannung 230 o 400 dreiphasig, Nennleistung 7.5 kW - 400Vac, software Standard, I/O Standard, integrato Filter A klasse.



Serie Drive Series Antrieb - Serie	Potenza Power Leistung	Software	I/O	Filtro EMC EMC Filter EMC-Filter	Freno Brake Unit Bremse
<b>T</b>	<b>370</b>	<b>X</b>	<b>B</b>	<b>X</b>	<b>B</b>

Inverter Serie T, alimentazione a 230 V trifase o 400 V trifase, potenza nominale 37 kW - 400 V, software standard, I/O opzionale Canbus montata, filtro EMC non presente, Brake Unit presente.

*Series inverter, voltage supply 230Vac or 400Vac three phase, nominal power 37 kW - 400V, software standard, I/O option for Canbus installed, integrated filter EMC not present, Brake Unit.*

T Serie Inverter, Spannung 230 o 400 dreiphasig, Nennleistung 37 kW - 400Vac, software Standard, I/O für Canbus integriert, integrato Filter A klasse.



**2.0 PICCOLE POTENZE  
CONTROLLO SEMPLICE**  
**0.25-1.1 kW 200-240 V**  
**0.12-0.55 kW 110 V**  
**ALIMENTAZIONE MONOFASE**

**CARATTERISTICHE PRINCIPALI:**

- V/F programmabile
- Motopotenziometro
- Regolatore PID
- Filtro EMC integrato (opzione)
- Autoreset programmabile
- Sovraccarico di corrente:  
150% per 60 sec. ogni 10 min.
- Frenatura in corrente continua
- Sovramodulazione
- Compensazione di scorrimento
- Massima frequenza di uscita: 1000 Hz
- Frequenza di commutazione:  
fino a 18 kHz
- Salti di frequenza
- Gestione buchi di rete
- Gestione prese di carico dinamiche
- Aggancio al volo
- Pannello controllo
- Chiave di programmazione
- Chiave di aggiornamento SW

**INGRESSI:**

- 4 ingressi digitali PNP (programmabili)
- Ingresso analogico (in alternativa 5°  
ingresso digitale) con offset e guadagno  
programmabile:  
0-10V 0-20mA 4-20mA
- 2° ingresso analogico (opzione)

**USCITE:**

- 1 uscita a relè (programmabile)
- 1 uscita digitale programmabile  
(opzione)

**PORTA SERIALE (opzione)**

**BUS di campo:**

- RS485 (protocollo Modbus)
- CANBUS (protocollo CanOpen  
o Device-net)

**PROTEZIONI:**

- sovracorrente-sovratensione
- sottotensione (soglia programmabile)
- sovratemperatura inverter
- sovraccarico (inverter, motore)
- cortocircuito tra fase e fase e tra fase  
e massa

**2.0 LOW POWER  
SIMPLE CONTROL**  
**0.25-1.1 kW 200-240 V**  
**0.12-0.55 kW 110 V**  
**SINGLE-PHASE POWER  
SUPPLY**

**MAIN FEATURES:**

- Programmable V/Hz
- Motorpotentiometer function
- PID regulator
- EMC integrated filter (option)
- Programmable autoreset
- Overload current:  
150% for 60 sec. every 10 minutes
- Dc braking control
- Overmodulation
- Slip compensation
- Maximum output frequency: 1000 Hz
- Switching frequency: up to 18 kHz
- Jump frequency
- Power loss management
- Overload dynamic management
- Flying restart
- Control panel
- Programming key
- Upgrade software key

**INPUT**

- 4 digital inputs PNP (programmable)
- Analog input (in alternative to 5 digital)  
with offset and gain programmable:  
0-10V 0-20mA 4-20mA
- 2nd analog input (option)

**OUTPUT:**

- 1 rele output (programmable)
- 1 digital output programmable (option)

**SERIAL PORT (option)**

**Field bus**

- RS485 (Modbus protocol)
- CANBUS (CanOpen or  
Device-net protocol)

**PROTECTIONS:**

- Overcurrent - Overvoltage
- Undervoltage (programmable threshold)
- Inverter overheating
- Overload (inverter, motor)
- Phase to phase and phase to ground
- short circuit

**2.0 NIEDRIGE LEISTUNGEN  
EINFACHE STEUERUNG**  
**0.25-1.1 kW 200-240 V**  
**0.12-0.55 kW 110 V**  
**EINPHASEN-VERSORGUNG**

**HAUPTMERKMALE:**

- V/Hz programmierbar
- Motorpotentiometer-Funktion
- PID-Regler
- Integrierter EMC-Filter (Option)
- Programmierbarer Autoreset
- Stromüberlast:  
150% für 60 Sek. alle 10 min.
- Gleichstrombremsung
- Übermodulierung
- Schlupfkompensation
- Max. Ausgangsfrequenz: 1000 Hz
- Schaltfrequenz: bis 18 kHz
- Frequenzsprung
- Netzausfallsteuerung
- Dynamisches Überlastmanagement
- Wiederankopplung
- Bedieneinheit
- Programmierschlüssel
- SW-Aktualisierungsschlüssel

**EINGÄNGE:**

- 4 digitale PNP-Eingänge  
(programmierbar)
- Analogeingang (als Alternative zum  
5. Digitaleingang) mit Offset und  
programmierbarer Signalverstärkung:  
0-10V 0-20mA 4-20mA
- 2. Analogeingang (Option)

**AUSGÄNGE:**

- 1 Relaisausgang (programmierbar)
- 1 Digitalausgang, programmierbar  
(Option)

**SERIELLE SCHNITTSTELLE (Option)**

**Feldbus:**

- RS485 (Modbus-Protokoll)
- Can-bus/Device-net  
(Protokoll CanOpen  
oder Device-net)

**SCHUTZEINRICHTUNGEN:**

- Überstrom-Überspannung
- Unterspannung  
(programmierbarer Schwellenwert)
- Übertemperatur - Umrichter
- Überlast (Umrichter, Motor)
- Kurzschluss zwischen Phasen  
und zwischen Phase und Masse

**2.1 DESIGNAZIONE INVERTER**
**2.1 INVERTER DESIGNATION**
**2.1 BEZEICHNUNG - UMRICHTER**

Modello / Model / Modell				Opzioni / Options / Optionen		
Serie Drive Series Antrieb - Serie	Tensione Voltage Spannung	Ingresso Supply Versorgung	Potenza Power Leistung	SW	I/O	Filtro EMC EMC Filter EMC-Filter
<b>A</b>	<b>2</b>	<b>M</b>	<b>004</b>	<b>X</b>	<b>Y</b>	<b>A</b>

Modello Model Modell	Potenza (kW) Power (kW) Leistung (kW)	Corrente uscita (A) Output current (A) Ausgangsstrom (A)	Frequenza uscita Output frequency Ausgangsfrequenz
<b>A2M 002</b>	0.25	1.7	Fino a 1000 Hz Up to 1000 Hz Bis 1000 Hz
<b>A2M 004</b>	0.37	2.2	
<b>A2M 005</b>	0.55	3.0	
<b>A2M 008</b>	0.75	3.9	
<b>A2M 011</b>	1.1	5.5	

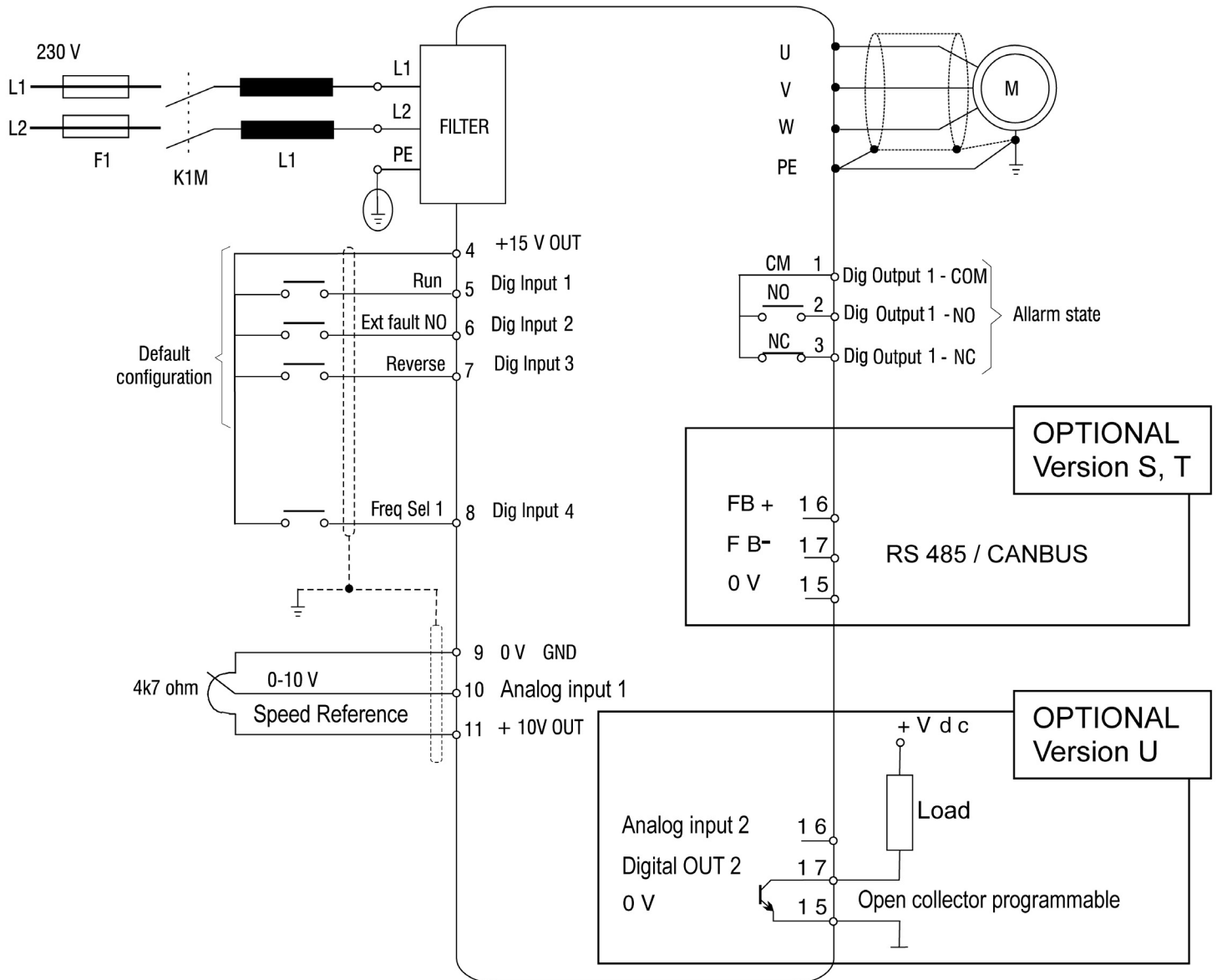
Opzione Options Optionen	Software	X=	standard	standard	standard	
		S=		+RS485 (Modbus)	+RS485 (Modbus)	+RS485 (Modbus)
		T=		+CANBUS (CanOpen, Devicenet)	+CANBUS (CanOpen, Devicenet)	+CANBUS (CanOpen, Devicenet)
		U=		+ 2° ingresso analogico + 1 uscita digitale	+ 2nd analog input + 1 digital output	+ 2. Analogeingang + 1 Digitalausgang
		Z=		Start/Stop + potenziometro	Start/Stop + potentiometer	Start/Stop + Potentiometer
	Filtro EMC EMC filter EMC-Filter	X=		non presente	not present	nicht vorhanden
		A=		filtro classe A	class A industrial level	Filter in Klasse A
		B=		filtro classe B	class B domestic level	Filter in Klasse B

<b>Tensione di ingresso / Voltage supply / Eingangsspannung</b>	220 V-15% / 240 V+10% 50-60 Hz, monofase / single phase / einphasig
<b>Sovraccarico corrente / Overload current / Überlaststrom</b>	150% 60 sec/10 min. / 60 s/10 min. / 60 Sek./10 min.
<b>Max Frequenza switching / Max Switching frequency / Max. Schaltfrequenz</b>	18 KHz
<b>Temperatura lavoro / Working temperature / Betriebstemperatur</b>	0-40°C assenza di condensa / absence of condensation keine Kondensation

2.2 COLLEGAMENTI

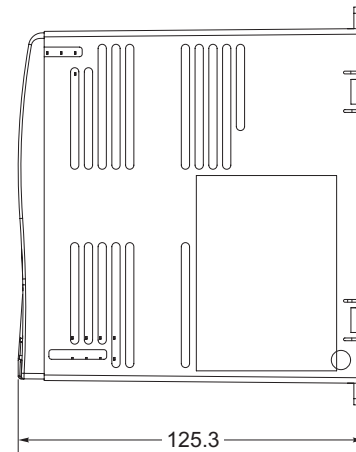
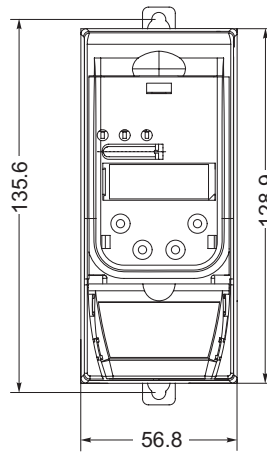
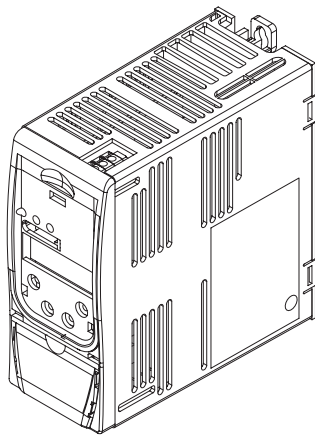
2.2 DRAWINGS

2.2 ANSCHLUSSPLAN



**2.3 ACCESSORI**
**2.3 ACCESSORIES**
**2.3 ZUBEHÖR**


<b>FLASH-LNK</b>	Tastiera ausiliaria RS485	<i>Auxiliary keyboard RS485</i>	Hilfstastatur RS485
<b>KN-PRGE</b>	Chiave esterna di programmazione	<i>Programming key</i>	Externer Programmierschlüssel
<b>SW-PRGE</b>	Chiave aggiornamento SW	<i>Programming update key</i>	SW-Aktualisierungsschlüssel

**2.4 DIMENSIONI**
**2.4 DIMENSIONS**
**2.4 MASSE**




### 3.0 CONTROLLO VETTORIALE PER BASSE POTENZE

0.75 – 2.2 kW

MONOFASE 220 Vac

TRIFASE 400 Vac

#### CARATTERISTICHE PRINCIPALI:

- V/Hz programmabile
- Compensazione scorrimento
- Boost automatico
- Regolatore PID
- Autoreset programmabile
- Frenatura in corrente continua
- Gestione buchi di rete
- Gestione stallo motore e blocco inverter
- Salti di frequenza
- Frequenza di uscita: 500 Hz
- Chiave di programmazione
- Motopotenziometro
- Sovramodulazione
- Gestione prese di carico dinamiche
- Aggancio al volo
- Pannello di controllo (opzione)

#### INGRESSI DIGITALI

PNP o NPN optoisolati:

- 5 ingressi digitali programmabili impostabili PNP o NPN

#### INGRESSO ANALOGICO:

- 2 ingressi analogici programmabili 0÷10 V, oppure ±10V oppure 0÷20 mA - 4÷20 mA

#### USCITA DIGITALE:

- 1 open collector NPN

#### INGRESSO ENCODER:

Opzione

#### USCITA A RELÈ:

- programmabile come: contatto di allarme, stato inverter, frequenza, rampe

#### USCITA ANALOGICA:

- 0÷10 V con offset e guadagno regolabili. Proporzionale a: frequenza, tensione motore, corrente, coppia, potenza e altre grandezze
- (±10 V opzione)

#### PORTA SERIALE:

Field bus

- RS485 (protocollo Modbus)
- RS485 optoisolata (opzione)
- CANBUS (protocollo CanOpen o Device-net)

#### PROTEZIONI

- Sovracorrente
- Sovratensione
- Sottotensione (soglia programmabile)
- Sovratemperatura inverter e motore
- Sovraccarico inverter, motore, resistenza di frenatura
- Mancanza fase
- Cortocircuito tra fase e fase e tra fase e terra
- Cortocircuito tra fase e fase e tra fase e massa

### 3.0 VECTOR CONTROL FOR LOW POWER

0.75 – 2.2 kW

1 - PHASE 220 Vac

3 - PHASE 400 Vac

#### MAIN FEATURES:

- Programmable V/Hz
- Slip compensation
- Automatic Boost
- PID regulator
- Programmable autoreset
- Dc braking control
- Power loss management
- Motor stall or inverter fault management
- Jump frequency
- Output frequency: 500 Hz
- Programming key
- Motopotentiometer
- Overmodulation
- Overload dynamic management
- Autocapture motor speed
- Control panel (option)

#### DIGITAL INPUTS

Optocoupled PNP or NPN:

- 5 digital input programmable setting PNP or NPN

#### ANALOG INPUT:

- 2 analog input programmable 0÷10 V, or ±10 V or 0÷20 mA - 4÷20 mA

#### DIGITAL OUTPUT:

- 1 open collector NPN

#### ENCODER INPUT:

Optional

#### RELAY OUTPUT:

- programmable: alarm indication, inverter status, frequency, ramps.

#### ANALOG OUTPUT:

- 0÷10 V with adjustable offset and gain. Proportional to: frequency, motor voltage, current, torque, power and other units
- (±10 V option)

#### SERIAL PORT:

Field bus

- RS485 (Modbus protocol)
- RS485 optocoupled (option)
- CANBUS (CanOpen or Device-net protocol)

#### PROTECTIONS:

- Overcurrent
- Undervoltage
- Overvoltage
- Undervoltage (programmable threshold)
- Overtemperature - inverter and motor
- Overload - inverter, motor, braking resistor
- Phase loss
- Phase to phase and phase to earth short circuit
- Phase to phase and phase to ground short circuit

### 3.0 VEKTORIALE STEUERUNG FÜR NIEDRIGE ANTRIEBSLEISTUNGEN

0.75 – 2.2 kW

EINPHASIG 220 Vac

DREIPHASIG 400 Vac

#### HAUPTMERKMALE:

- V/Hz programmierbar
- Schlupfkompensation
- Automatischer Boost
- PID-Regler
- Programmierbarer Autoreset
- Gleichstrombremsung
- Netzausfallsteuerung
- Management bei Überziehen des Motors und Blockierung des Frequenzumrichters
- Frequenzsprung
- Ausgangsfrequenz: 500 Hz
- Programmierschlüssel
- Motorpotentiometer-Funktion
- Übermodulierung
- Dynamisches Überlastmanagement
- Wiederankopplung
- Bedienfeld (Option)

#### DIGITALEINGÄNGE

Optoisolierte PNP- oder NPN-Eingänge:

- 5 programmierbare Digitaleingänge, als PNP- oder NPN-Eingänge einstellbar

#### ANALOGUEINGANG:

- 2 Analogeingänge programmierbar mit 0÷10 V - oder ±10 V oder 0÷20 mA - 4÷20 mA

#### DIGITALAUSGANG:

- 1 NPN-Ausgang open collector

#### ENCODEREINGANG:

Option

#### RELAISAUSGANG:

- programmierbar für: Alarm, Umrichterzustand, Frequenz, Rampen

#### ANALOGAUSGANG:

- 0÷10 V Offset und Verstärkung regulierbar. Proportional zu: Frequenz, Motorspannung, Strom, Drehmoment, Leistung und anderen Größen
- (±10 V Option)

#### SERIELLE SCHNITTSTELLE:

Feldbus

- RS485 (Modbus-Protokoll)
- RS485 optoisoliert (Option)
- CANBUS (Protokoll CanOpen oder Device-net)

#### SCHUTZEINRICHTUNGEN

- Überstrom
- Überspannung
- Unterspannung (programmierbarer Schwellenwert)
- Übertemperatur - Umrichter und Motor
- Überlast - Umrichter, Motor, Bremswiderstand
- Keine Phase
- Kurzschluss zwischen Phasen und zwischen Phase und Erde
- Kurzschluss zwischen Phasen und zwischen Phase und Masse

**3.1 DESIGNAZIONE INVERTER**
**3.1 INVERTER DESIGNATION**
**3.1 BEZEICHNUNG - FREQUENZUMRICHTER**

Modello / Model / Modell				Opzioni / Options / Optionen			
Serie Drive Series Antrieb - Serie	Tensione Voltage Spannung	Ingresso Supply Versorgung	Potenza Power Leistung	SW	I/O	Filtro EMC EMC Filter EMC-Filter	Freno Brake Unit Bremse
<b>R</b>	<b>2</b>	<b>T</b>	<b>015</b>	<b>X</b>	<b>X</b>	<b>X</b>	<b>X</b>

Tensione di ingresso / Voltage supply / Spannungsversorgung		
<b>2M</b>	220V-15% 240+10	monofase single phase einphasig
<b>2T</b>	220V-15% 240+10%	trifase three phase dreiphasig
<b>4T</b>	380-15% 460+10%	trifase three phase dreiphasig

<b>Sovraccarico corrente Overload current Überlaststrom</b>	150% 30 sec ogni 20 min 30 s ever 20 min 30 Sek./20 min.
<b>Max Frequenza switching Max Switching frequency Max. Schaltfrequenz</b>	18 KHz
<b>Temperatura lavoro Working temperature Betriebstemperatur</b>	0-40°C assenza di umidità absence of humidity keine Feuchtigkeit

Modello Model Modell	Potenza (kW) Power (kW) Leistung (kW)	Uscita corrente (A) Output current (A) Ausgangsstrom (A)	Uscita frequenza Output frequency Ausgangsfrequenz
<b>R 2M 004</b>	0.37	2.2	Fino a 500 Hz Up to 500 Hz Bis 500 Hz
<b>R 2M 008</b>	0.75	3.9	
<b>R 2M 011</b>	1.1	5.5	
<b>R 2M 015</b>	1.5	7	
<b>R 2M 022</b>	2.2	9	
<b>R 2T 004</b>	0.37	2.2	
<b>R 2T 008</b>	0.75	3.9	
<b>R 2T 011</b>	1.1	5.5	
<b>R 2T 015</b>	1.5	7	
<b>R 4T 004</b>	0.37	1.3	
<b>R 4T 008</b>	0.75	2.2	
<b>R 4T 011</b>	1.1	2.8	
<b>R 4T 015</b>	1.5	4	
<b>R 4T 022</b>	2.2	5.5	

Opzioni Options Optionen	SW	<b>X=</b>	standard	standard	standard
	I/O	<b>X=</b>	standard	standard	standard
		<b>E=</b>	ingresso Encoder	Encoder input	Encoder-Eingang
		<b>M=</b>	Uscita Analogica +/- 10V	Analog Output +/- 10V	Analogeingang +/- 10V
		<b>O=</b>	RS 485 Optoisolata (Modbus)	Opto-coupled RS 485 (Modbus)	RS 485 optoisoliert (Modbus)
		<b>T=</b>	CANBUS (CanOpen / Devicenet)	CANBUS (CanOpen / Devicenet)	CANBUS (CanOpen / Devicenet)
	Filtro EMC EMC Filter EMC-Filter	<b>X=</b>	non presente	not present	nicht vorhanden
		<b>A=</b>	filtro classe A	A filter	A Filter
	Freno Brake unit Bremseinheit	<b>X=</b>	non presente	not present	nicht vorhanden
		<b>B=</b>	presente	present	vorhanden

\* Le versioni opzionali T, O, E e M sono da definire in fase di ordine e hanno l'I/O della versione standard X più le funzionalità descritte.

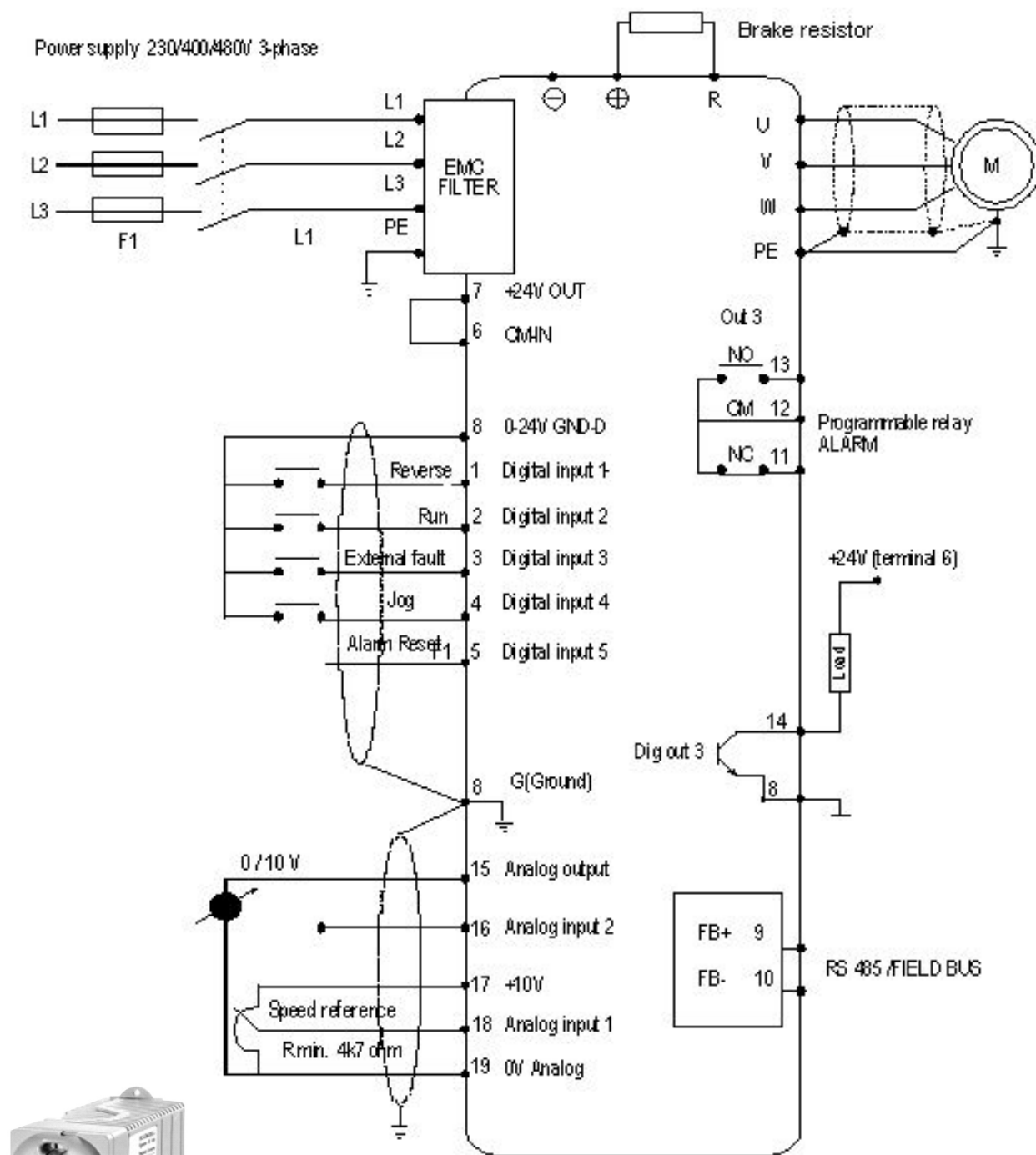
\* Options T, O, E and M must be agreed upon on order; these options feature the same I/O as the standard X version and the additional functions described herein.

\* Die Optionalversionen T, O, E und M müssen in der Auftragphase definiert werden. Sie haben den I/O gemäß Standardversion X mit den beschriebenen Funktionen.

3.2 COLLEGAMENTI

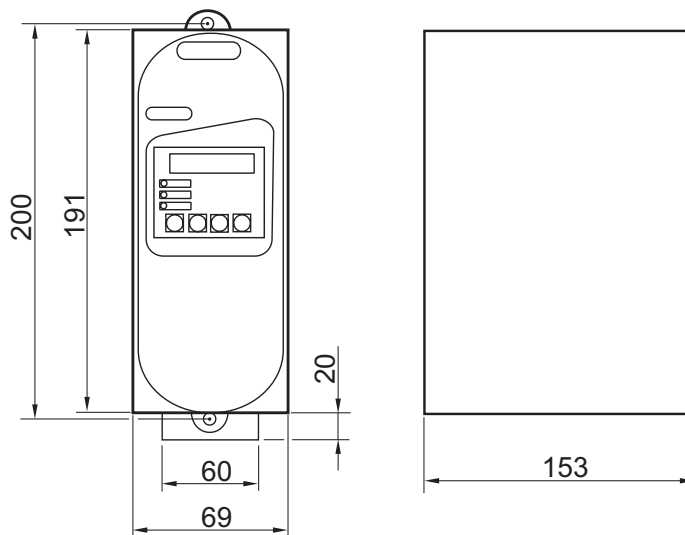
3.2 DRAWINGS

3.2 ANSCHLUSSPLAN



**3.3 ACCESSORI**
**3.3 ACCESSORIES**
**3.3 ZUBEHÖR**


<b>FXX TST</b>	Tastierino di programmazione	<i>Programming Keyboard</i>	Programmiertastatur
<b>AUX TST</b>	Tastiera ausiliaria con 2 Mt di cavo	<i>Auxiliary keyboard with 2 Mt cable</i>	Hilfstastatur mit 2 m Kabel
<b>KN-PRGE</b>	Chiave esterna di programmazione	<i>Programming Key</i>	Externer Programmierschlüssel
<b>AUX 232/485</b>	Scheda interfaccia seriale RS232 – RS485	<i>Serial Interface card RS232 - RS485</i>	Serielle Schnittstellenkarte RS232 – RS485
<b>IR3F-01.5</b>	Induttanza di rete trifase per 2T004-2T008	<i>Three-phase input choke for 2T004-2T008</i>	Induktanz - Dreiphasennetz für 2T004-2T008
<b>IR3F-022</b>	Induttanza di rete trifase per 2T011	<i>Three-phase input choke for 2T011</i>	Induktanz - Dreiphasennetz für 2T011
<b>IR3F-030</b>	Induttanza di rete trifase per 2T015	<i>Three-phase input choke for 2T015</i>	Induktanz - Dreiphasennetz für 2T015
<b>IR3F-00.8</b>	Induttanza di rete trifase per 4T004-4T008	<i>Three-phase input choke for 4T004-4T008</i>	Induktanz - Dreiphasennetz für 4T004-4T008
<b>IR3F-01.5</b>	Induttanza di rete trifase per 4T011-4T015	<i>Three-phase input choke for 4T011-4T015</i>	Induktanz - Dreiphasennetz für 4T011-4T015
<b>IR3F-022</b>	Induttanza di rete trifase per 4T022	<i>Three-phase input choke for 4T022</i>	Induktanz - Dreiphasennetz für 4T022

**3.4 DIMENSIONI**
**3.4 DIMENSIONS**
**3.4 MASSE**




#### 4.0 CONTROLLO VETTORIALE PER MEDIE POTENZE 3-18.5 kW con 380-480V 1.5-11 kW con 230V ALIMENTAZIONE TRIFASE

##### CARATTERISTICHE PRINCIPALI:

- V/Hz programmabile
- Compensazione scorrimento
- Boost automatico
- Regolatore PID
- Autoreset programmabile
- Frenatura in corrente continua
- Gestione Buchi e Mancanza rete
- Gestione stallo motore e blocco inverter
- Salti di frequenza
- Frequenza di uscita: 0.1÷1000 Hz
- Chiave di programmazione
- Motopotenziometro
- Sovramodulazione
- Gestione prese di carico dinamiche
- Sovraccarico 180% per 40 sec. ogni 10 minuti
- Aggancio al volo
- Pannello di controllo
- Unità di frenatura integrata
- Protezione termica del motore e della resistenza di frenatura
- Filtro EMC integrato classe A (opzionale) o classe B esterno.

##### INGRESSI DIGITALI

- 4 Ingressi digitali programmabili
- 1 Ingresso Encoder TTL/HTL configurabile come 2 ingressi digitali PNP o NPN

##### USCITE DIGITALI

- 2 USCITE a relè programmabile NO/NC
- 2 USCITE digitali programmabili open collector NPN

##### INGRESSI ANALOGICI

- 1 segnale configurabile come:  $\pm 10$  Vdc, o 0÷20 mA, o 4÷20 mA
- 1 segnale differenziale configurabile come:  $\pm 10$  Vdc, o 0÷20 mA, o 4÷20 mA

##### USCITE ANALOGICHE

- 1 segnale uscita  $\pm 10$  Vdc

##### PORTA SERIALE:

- RS485 (protocollo Modbus)
- CANBUS (protocollo CanOpen o Device-net)
- Profibus

##### POTENZIONI

- Sovracorrente
- Sovratensione
- Sottotensione (soglia programmabile)
- Sovratemperatura inverter
- Sovraccarico inverter, motore, resistenza di frenatura
- Mancanza fase
- Cortocircuito tra fase e fase e tra fase e massa

#### 4.0 MEDIUM POWER DRIVE VECTOR CONTROL 3-18.5 kW with 380-480V 1.5-11 kW with 230V 3 - PHASE POWER SUPPLY

##### MAIN FEATURES:

- Programmable V/Hz
- Slip compensation
- Automatic Boost
- PID regulator
- Programmable autoreset
- Dc braking control
- Power loss management
- Motor stall or inverter fault management
- Jump frequency
- Output frequency: 0.1÷1000 Hz
- Programming key
- Motopotentiometer
- Overmodulation
- Overload dynamic management
- Overload 180% for 40 sec. every 10 min.
- Autocapture function (Flying restart)
- Control panel
- Integrated braking unit
- Motor and brake resistor thermal protection
- EMC filter: internal, class A (option) or external, class B.

##### DIGITAL INPUT

- 4 digital programmable input
- 1 Encoder input TTL/HTL configurable like 2 digital PNP or NPN input

##### DIGITAL OUTPUT

- 2 programmable relè output NO/NC
- 2 programmable digital output open collector NPN

##### ANALOG INPUT

- 1 analog signal  $\pm 10$  Vdc, or 0÷20 mA, or 4÷20 mA
- 1 analog differential  $\pm 10$  Vdc, or 0÷20 mA, or 4÷20 mA

##### ANALOG OUTPUT

- 1 signal output  $\pm 10$  Vdc

##### SERIAL PORT:

- RS485 (Modbus protocol)
- CANBUS (CanOpen or Device-net protocol)
- Profibus

##### PROTECTIONS:

- Overcurrent
- Overvoltage
- Undervoltage (programmable threshold)
- Overheating inverter
- Overload inverter, motor, braking resistor
- Phase loss
- Phase to phase and phase to ground short circuit

#### 4.0 VEKTORIALE STEUERUNG FÜR MITTLERE ANTRIEBSLEISTUNGEN 3-18.5 kW mit 380-480V 1.5-11 kW mit 230V DREIPHASIG-VERSORGUNG

##### HAUPTMERKMALE:

- V/Hz programmierbar
- Schlupfkompensation
- Automatischer Boost
- PID-Regler
- Programmierbarer Autoreset
- Gleichstrombremsung
- Netzausfallsteuerung
- Management bei Überziehen des Motors und Blockierung des Frequenzumrichters
- Frequenzsprung
- Ausgangsfrequenz: 0.1÷1000 Hz
- Programmierschlüssel
- Motorpotentiometer-Funktion
- Übermodulierung
- Dynamisches Überlastmanagement
- Überlast 180% für 40 Sek. alle 10 Minuten
- Wiederankopplung
- Bedieneinheit
- Integrierte Bremsenheit
- Thermischer Überlastschutz für Motor und Bremswiderstand
- Integrierter EMC-Filter der Klasse A (Optional) oder Klasse B extern.

##### DIGITALEINGÄNGE

- 4 programmierbare Digitaleingänge
- 1 Encodereingang TTL/HTL als 2 digitale PNP- oder NPN-Eingänge konfigurierbar

##### DIGITALAUSGÄNGE

- 2 programmierbare NO/NC-Relaisausgänge
- 2 programmierbare NPN-Digitaleingänge open collector

##### ANALOGGEINGÄNGE

- 1 Signal, konfigurierbar in:  $\pm 10$  Vdc, oder 0÷20 mA, oder 4÷20 mA
- 1 Differenzialsignal, konfigurierbar in:  $\pm 10$  Vdc, oder 0÷20 mA, oder 4÷20 mA

##### ANALOGAUSGÄNGE

- 1 Ausgangssignal  $\pm 10$  Vdc

##### SERIELLE SCHNITTSTELLE:

- RS485 (Modbus-Protokoll)
- CANBUS (Protokoll CanOpen oder Device-net)
- Profibus

##### SCHUTZEINRICHTUNGEN

- Überstrom
- Überspannung
- Unterspannung (programmierbarer Schwellenwert)
- Übertemperatur - Umrichter
- Überlast - Umrichter, Motor, Bremswiderstand
- Keine Phase
- Kurzschluss zwischen Phasen und zwischen Phase und Masse

**4.1 DESIGNAZIONE INVERTER**
**4.1 INVERTER DESIGNATION**
**4.1 BEZEICHNUNG -  
FREQUENZUMRICHTER**

Modello / Model / Modell		Configurazione / Configuration / Konfiguration		
Serie Drive Series Antrieb - Serie	Potenza Power Leistung	SW	I/O	Filtro EMC EMC Filter EMC-Filter
<b>V</b>	<b>040</b>	<b>X</b>	<b>X</b>	<b>X</b>

Modello Model Modell	Potenza (kW) Power (kW) Leistung (kW)	Uscita corrente (A) Output current (A) Ausgangsstrom (A)	Uscita frequenza Output frequency Ausgangsfrequenz
V 030	3	7.5	Fino a 1000 Hz Up to 1000 Hz Bis 1000 Hz
V 040	4	9	
V 055	5.5	12.5	
V 075	7.5	17	
V 110	11	25	
V 150	15	33	
V 185	18.5	38	

Opzioni Options Optionen	SW	X=	standard	standard	standard
	I/O	X=	I/O standard con PL-485I	Standard I/O with PL-485I	I/O Standard mit PL-485I
		P=	I/O standard con PL-Profibus	Standard I/O with PL-Profibus	I/O Standard mit PL-Profibus
		C=	I/O standard con PL-CANBUS	Standard I/O with PL-CANBUS	I/O Standard mit PL-CANBUS
	Filtro EMC EMC Filter EMC-Filter	X=	non presente	not present	nicht vorhanden
		A=	filtro classe A	class A industrial level	Filter in Klasse A

\* per la descrizione dei codici PL- vedere la sezione OPZIONI

\* For PL code descriptions please see section OPTIONS

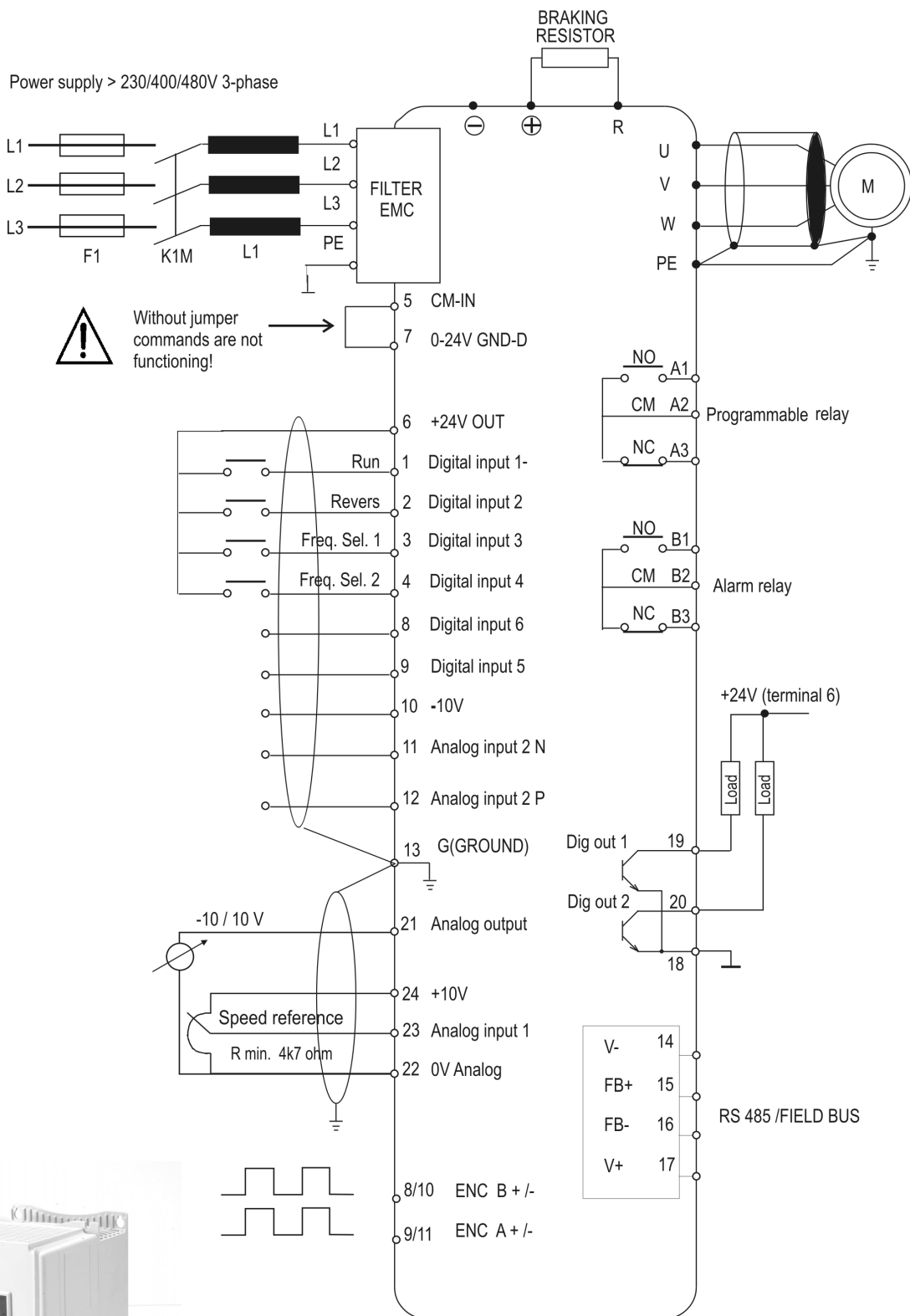
\* bezüglich der Beschreibung der Codes PL- siehe Abschnitt OPTIONEN

<b>Tensione di ingresso / Voltage supply / Eingangsspannung</b>	230 V-15% / 460 V+10% 50-60 Hz
<b>Sovraccarico corrente / Overload current / Überlaststro</b>	180% 40 sec/10 min 40 s/10 min. 40 Sek./10 min.
<b>Max Frequenza switching / Max Switching frequency / Max. Schaltfrequenz</b>	18 KHz
<b>Temperatura lavoro / Working temperature / Betriebstemperatur</b>	0-40°C assenza di condensa absence of condensation keine Kondensation

4.2 COLLEGAMENTI

4.2 DRAWINGS

4.2 ANSCHLUSSPLAN



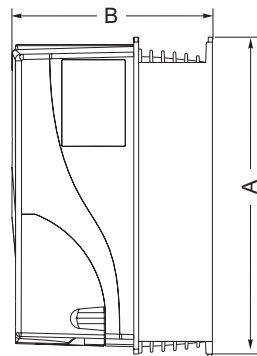
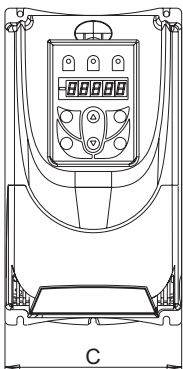
**4.3 ACCESSORI**
**4.3 ACCESSORIES**
**4.3 ZUBEHÖR**


<b>FLASH-TST</b>	Tastiera di controllo	<i>Control keyboard</i>	Steuertastatur
<b>FLASH-LNK</b>	Tastiera ausiliaria RS485	<i>Auxiliary keyboard RS485</i>	Hilfstastatur RS485
<b>KBV</b>	Kit remotazione (2m) per tastiera FLASH-TST	<i>Remote FLASH-TST keyboard kit (2 m)</i>	Kit Remote FLASH-TST für Tastatur (2m)
<b>KN-PRGE</b>	Chiave esterna di programmazione	<i>Programming key</i>	Externer Programmierschlüssel
<b>AUX 232/485</b>	Scheda interfaccia RS232 -RS485	<i>Serial interface: RS232 - RS485</i>	Schnittstellenkarte RS232-RS485

<b>IR 3F-030</b>	Induttanza di rete trifase per 3 kW	<i>AC input three phase choke for 3 kW</i>	Induktanz Dreiphasennetz für 3 kW
<b>IR 3F-040</b>	Induttanza di rete trifase per 4 kW	<i>AC input three phase choke for 4 kW</i>	Induktanz - Dreiphasennetz für 4 kW
<b>IR 3F-055</b>	Induttanza di rete trifase per 5.5 kW	<i>AC input three phase choke for 5.5 kW</i>	Induktanz - Dreiphasennetz für 5.5 kW
<b>IR 3F-075</b>	Induttanza di rete trifase per 7.5 kW	<i>AC input three phase choke for 7.5 kW</i>	Induktanz - Dreiphasennetz für 7.5 kW
<b>IR 3F-011</b>	Induttanza di rete trifase per 11 kW	<i>AC input three phase choke for 11 kW</i>	Induktanz - Dreiphasennetz für 11 kW
<b>IR 3F-015</b>	Induttanza di rete trifase per 15 kW	<i>AC input three phase choke for 15 kW</i>	Induktanz - Dreiphasennetz für 15 kW
<b>IR 3-022</b>	Induttanza di rete trifase per 18.5 kW	<i>AC input three phase choke for 18.5 kW</i>	Induktanz - Dreiphasennetz für 18.5 kW

**4.4 OPZIONI**
**4.4 OPTIONS**
**4.4 OPTIONEN**

<b>PL-RS485I</b>	Scheda interfaccia RS485 OPTOISOLATA (Modbus)	<i>Optocoupled interface board</i>	OPTOISOLATA-Schnittstellenkarte RS485/ModBus photokoppler
<b>PL-CANBUS</b>	Scheda interfaccia CANBUS	<i>Interface board CANBUS</i>	CANBUS-Schnittstellenkarte
<b>PL-Profibus</b>	Scheda interfaccia Profibus	<i>Interface board Profibus</i>	Profibus-Schnittstellenkarte

**4.5 DIMENSIONI**
**4.5 DIMENSIONS**
**4.5 MASSE**


[mm]	C	B	A
<b>Taglia 1 Size 1 Baugröße 1</b>	145.0	165.0	260.0
<b>Taglia 1 Size 2 Baugröße 2</b>	165.5	188.2	323.0

**4.6 FILTRO EMC INTEGRATO**
**4.6 INTERNAL EMC FILTER**
**4.6 INTEGRIERTER EMC-FILTER**

Modello / Model / Modell	Taglia 1 / Size 1 / Baugröße 1	Taglia 2 / Size 2 / Baugröße 2
<b>V 030</b>	X	
<b>V 040</b>	X	
<b>V 055</b>	X	
<b>V 075</b>		X
<b>V 110</b>		X
<b>V 150</b>		X
<b>V 185</b>		-



**5.0 CONTROLLO VETTORIALE  
PER ALTE POTENZE  
22-200 kW con 380-480V  
11-100 kW con 230V  
ALIMENTAZIONE TRIFASE**

**CARATTERISTICHE PRINCIPALI:**

- V/Hz programmabile
- Compensazione scorrimento
- Boost automatico
- Regolatore PID
- Autoreset programmabile
- Frenatura in corrente continua
- Gestione buchi e mancanza rete
- Gestione stallo motore e blocco inverter
- Salti di frequenza
- Chiave di programmazione
- Motopotenziometro
- Sovramodulazione
- Gestione prese di carico dinamiche
- Sovraccarico 150% per 60 sec. ogni 5 minuti
- Aggancio al volo
- Pannello di controllo
- Unità di frenatura integrata
- Protezione termica del motore e della resistenza di frenatura

**INGRESSI DIGITALI**

- 8 Ingressi digitali programmabili

**USCITE DIGITALI**

- 2 USCITE a relè programmabile NO/NC
- 2 USCITE digitali programmabili open collector NPN

**INGRESSO ENCODER:**

Scheda opzionale

**INGRESSI ANALOGICI**

- 3 segnali configurabili come:  $\pm 10$  Vdc, o  $0\div 20$  mA, o  $4\div 20$  mA

**USCITE ANALOGICHE**

- 2 uscite  $\pm 10$  Vdc

**PORTA SERIALE:**

- RS485 (protocollo Modbus)
- CANBUS (protocollo CanOpen o Device-net)
- Profibus

**PROTEZIONI**

- Sovracorrente
- Sovratensione
- Sottotensione (soglia programmabile)
- Sovratemperatura inverter
- Sovraccarico inverter, motore, resistenza di frenatura
- Mancanza fase
- Cortocircuito tra fase e fase e tra fase e massa

**5.0 HIGH POWER DRIVE  
VECTOR CONTROL  
22-200 kW with 380-480V  
11-100 kW with 230V  
3 - PHASE POWER SUPPLY**

**MAIN FEATURES:**

- Programmable V/Hz
- Slip compensation
- Automatic Boost
- PID regulator
- Programmable autoreset
- Dc braking control
- Power loss management
- Motor stall or inverter fault management
- Jump frequency
- Programming key
- Motopotentiometer
- Overmodulation
- Overload dynamic management
- Overload 150% for 60 sec. every 5 min.
- Autocapture function (Flying restart)
- Control panel
- Integrated braking unit
- Motor and brake resistor thermal protection

**DIGITAL INPUTS**

- 8 digital programmable inputs

**DIGITAL OUTPUTS**

- 2 programmable NO/NC relay outputs
- 2 programmable open collector NPN digital outputs

**ENCODER INPUT:**

Optional card

**ANALOG INPUTS**

- 3 analog signal configurable settings:  $\pm 10$  Vdc, or  $0\div 20$  mA, or  $4\div 20$  mA

**ANALOG OUTPUTS**

- 2 outputs  $\pm 10$  Vdc

**SERIAL PORT:**

- RS485 (Modbus protocol)
- CANBUS (CanOpen or Device-net protocol)
- Profibus

**PROTECTIONS:**

- Overcurrent
- Overvoltage
- Undervoltage (programmable threshold)
- Overheating inverter
- Overload inverter, motor, braking resistor
- Phase loss
- Phase to phase and phase to ground short circuit

**5.0 VEKTORIALE STEUERUNG FÜR  
HOHE ANTRIEBSLEISTUNGEN  
22-200 kW mit 380-480V  
11-100 kW mit 230V  
DREIPHASIG-VERSORGUNG**

**HAUPTMERKMALE:**

- V/Hz programmierbar
- Schlupfkompensation
- Automatischer Boost
- PID-Regler
- Programmierbarer Autoreset
- Gleichstrombremsung
- Netzausfallsteuerung
- Management bei Überziehen des Motors und Blockierung des Frequenzumrichters
- Frequenzsprung
- Programmierschlüssel
- Motorpotentiometer-Funktion
- Übermodulierung
- Dynamisches Überlastmanagement
- Überlast 150% für 60 Sek. alle 5 Minuten
- Wiederankopplung
- Bedieneinheit
- Integrierte Bremsenheit
- Thermischer Überlastschutz für Motor und Bremswiderstand

**DIGITALEINGÄNGE**

- 8 programmierbare Digitaleingänge

**DIGITALAUSGÄNGE**

- 2 programmierbare NO/NC-Relaisausgänge
- 2 programmierbare NPN-Digitaleingänge open collector

**ENCODEREINGANG:**

Optionalkarte

**ANALOGEINGÄNGE**

- 3 Signale, konfigurierbar in:  $\pm 10$  Vdc, oder  $0\div 20$  mA, oder  $4\div 20$  mA

**ANALOGAUSGÄNGE**

- 2 Ausgänge  $\pm 10$  Vdc

**SERIELLE SCHNITTSTELLE:**

- RS485 (Modbus-Protokoll)
- CANBUS (Protokoll CanOpen oder Device-net)
- Profibus

**SCHUTZEINRICHTUNGEN**

- Überstrom
- Überspannung
- Unterspannung (programmierbarer Schwellenwert)
- Übertemperatur - Umrichter
- Überlast - Umrichter, Motor, Bremswiderstand
- Keine Phase
- Kurzschluss zwischen Phasen und zwischen Phase und Masse

**5.1 DESIGNAZIONE INVERTER**
**5.1 INVERTER DESIGNATION**
**5.1 BEZEICHNUNG - FREQUENZUMRICHTER**

Modello / Model / Modell		Opzioni / Options / Optionen			
Serie <i>Drive Series</i> Antrieb - Serie	Potenza <i>Power</i> Leistung	SW	I/O	Filtro EMC <i>EMC Filter</i> EMC-Filter	Freno <i>Brake Unit</i> Bremsen
<b>T</b>	<b>220</b>	<b>X</b>	<b>X</b>	<b>X</b>	<b>X</b>

Modello <i>Model</i> Modell	Potenza (kW) 400 Vac <i>Power (kW) 400 Vac</i> Leistung (kW) 400 Vac	Uscita corrente (A) <i>Output current (A)</i> Ausgangsstrom (A)	Uscita frequenza <i>Output frequency</i> Ausgangsfrequenz
<b>T 220</b>	22	43	Fino a 500 Hz <i>Up to 500 Hz</i> Bis 500 Hz
<b>T 300</b>	30	57	
<b>T 370</b>	37	72	
<b>T 450</b>	45	85	Fino a 200 Hz <i>Up to 200 Hz</i> Bis 200 Hz
<b>T 550</b>	55	104	
<b>T 750</b>	75	129	
<b>T 900</b>	90	188	
<b>T 1100</b>	110	191	
<b>T 1320</b>	132	227	
<b>T 1600</b>	160	295	
<b>T 2000</b>	200	364	

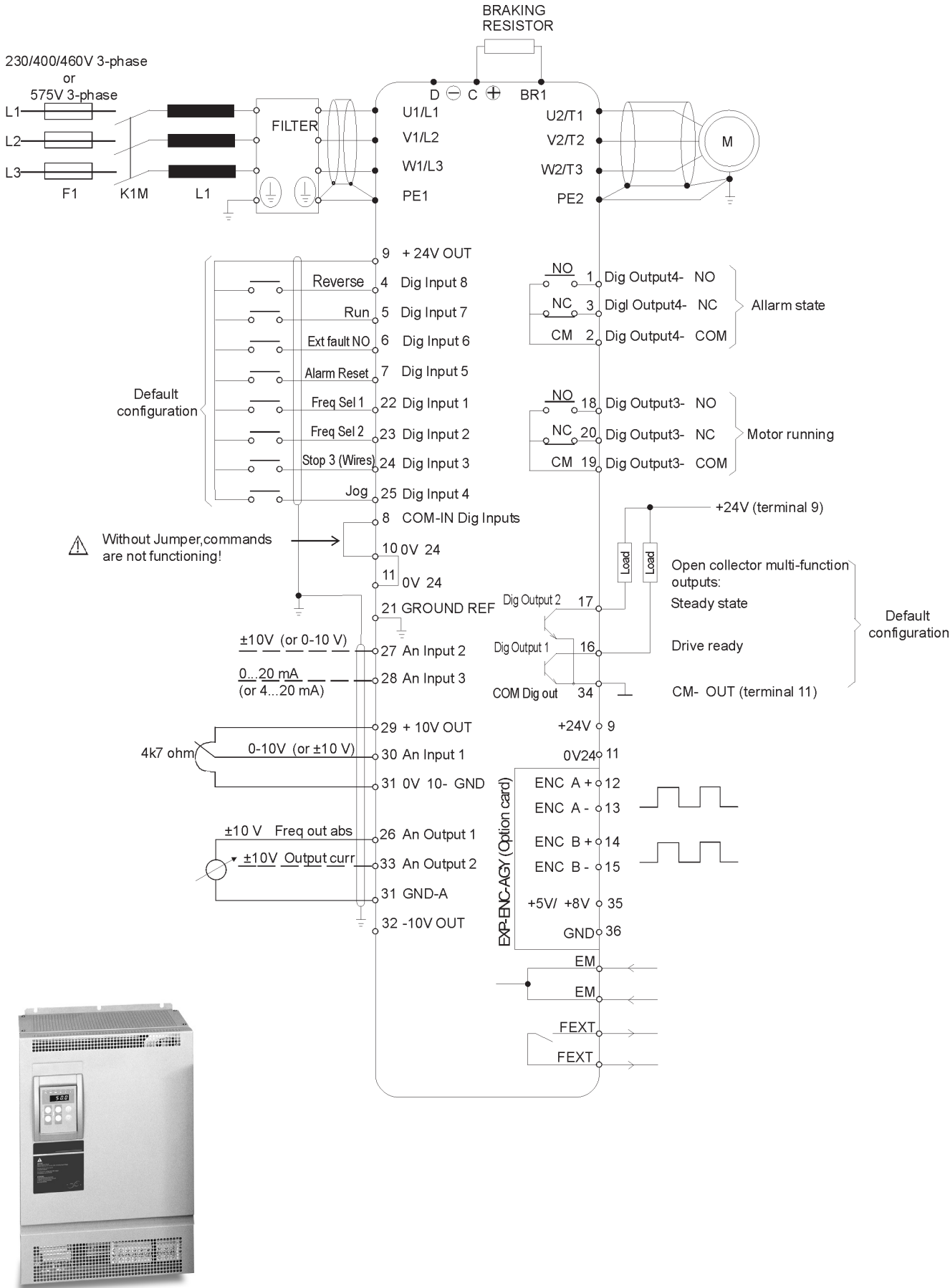
Opzioni <i>Options</i> Optionen	SW	X=	standard	<i>standard</i>	standard
	I/O	X=	standard	<i>standard</i>	standard
		B=	Canbus	<i>Canbus</i>	Canbus
	Filtro EMC <i>EMC Filter</i> EMC-Filter	X=	non presente	<i>not present</i>	nicht vorhanden
Frenatura <i>Brake</i> Bremsung	X=	non presente	<i>not present</i>	nicht vorhanden	
	B=	con unità interna solo da 22 a 55 kW	<i>with integrated braking circuit only from 22 to 55 kW</i>	mit interner Einheit nur von 22 bis 55 kW	

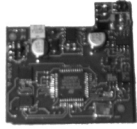
<b>Tensione di ingresso / Voltage supply / Eingangsspannung</b>	230 V-15% / 460 V+10% 50-60 Hz
<b>Sovraccarico corrente / Overload current / Überlaststro</b>	150% 60 sec/5 min 60 s/5 min. 60 Sek./5 min.
<b>Max Frequenza switching / Max Switching frequency / Max. Schaltfrequenz</b>	16 kHz da 22 a 37 kW 8 kHz da 45 a 132 kW 4kHz da 160 a 200 kW <i>16 kHz with integrated braking circuit only from 22 to 37 kW</i> <i>8 kHz with integrated braking circuit only from 45 to 132 kW</i> <i>4 kHz with integrated braking circuit only from 160 to 200 kW</i> 16 kHz von 22 bis 37 kW / 16 kHz mit integriertem Bremserschaltkreis nur von 22 bis 37 kW 8 kHz von 45 bis 132 kW / 8 kHz mit integriertem Bremserschaltkreis nur von 45 bis 132 kW 4 kHz von 160 bis 200 kW / 4 kHz mit integriertem Bremserschaltkreis nur von 160 bis 200 kW
<b>Temperatura lavoro / Working temperature / Betriebstemperatur</b>	0-40°C assenza di umidità <i>absence of humidity</i> keine Feuchtigkeit
<b>Temperatura magazzino / Storage temperature / Lagerungstemperatur</b>	-20 +55°C assenza di umidità <i>absence of humidity</i> keine Feuchtigkeit

5.2 COLLEGAMENTI

5.2 DRAWINGS

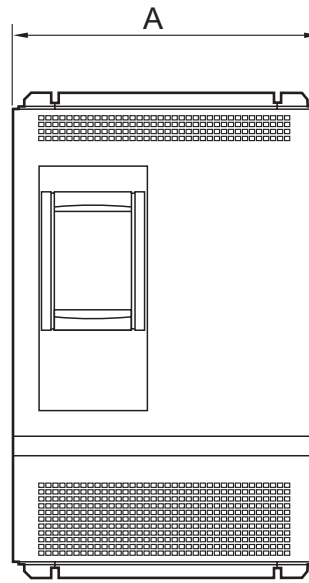
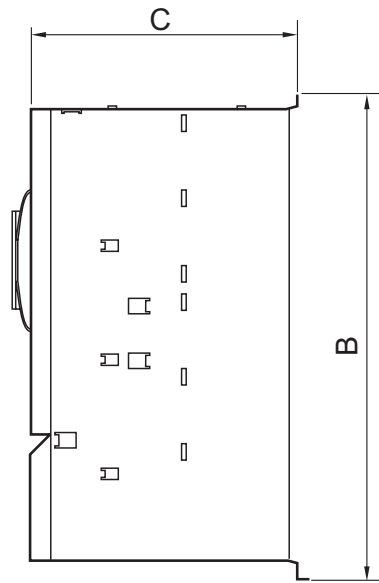
5.2 ANSCHLUSSPLAN



**5.3 ACCESSORI**
**5.3 ACCESSORIES**
**5.3 ZUBEHÖR**


<b>FOXG-TST</b>	Tastierino di programmazione	<i>Programming keypad</i>	Programmiertastatur
<b>KBG</b>	Kit remotazione per FOXG-TST	<i>Remote FOXG-TST kit</i>	Kit Remote für FOXG-TST
<b>KN-PRGE</b>	Chiave esterna di programmazione	<i>External programming key</i>	Externer Programmierschlüssel
<b>AUX 232/485</b>	Scheda interfaccia RS232 - RS485	RS232 - RS485 interface card	Schnittstellenkarte RS232 – RS485
<b>EXP-D6A1R 1-FOXG</b>	Espansione 4 Ing. Digitali/2 Uscite Digitali/1 relè	Expansion 4 Digital inputs /2 Digital outputs /1 relay	Erweiterung 4 Digitaleingänge/2 Digitalausgänge/1 Relais
<b>EXP-D8-120</b>	Interfaccia I/O Digitali (8 Ing. A 120 Vac - 8 Uscite a 24 Vdc)	I/O Digital Interface (8 IN: 120 Vac - 8 OUT: 24 Vdc)	I/O Digitalschnittstelle (8 Eing. mit 120 Vac - 8 Ausgänge mit 24 Vdc)
<b>SBI-PDP-FOXG</b>	Interfaccia ProfiBus	Profibus interface	Profibus-Schnittstelle
<b>T-ENC</b>	Interfaccia Encoder	Encoder interface	Encoder-Schnittstelle

<b>BUy1050</b>	Unità di frenatura 50A medi - Alimentazione da DC bus	<i>UL Brake unit : 50A medium - DC Supply: bus - UL</i>	Bremseinheit 50 A Mittelwert- Versorgung über DC-Bus
<b>BUy1085</b>	Unità di frenatura 85A medi - Alimentazione da DC bus	<i>UL Brake unit 85A medium - Dc supply: bus - UL</i>	Bremseinheit 85 A Mittelwert - Versorgung über DC-Bus
<b>IR 3-022</b>	Induttanza di rete trifase per 22 kW	<i>AC input three phase choke for 22 kW</i>	Induktanz - Dreiphasennetz für 22 kW
<b>IR 3-030</b>	Induttanza di rete trifase per 30 kW	<i>AC input three phase choke for 30 kW</i>	Induktanz - Dreiphasennetz für 30 kW
<b>IR 3-037</b>	Induttanza di rete trifase per 37 kW	<i>AC input three phase choke for 37 kW</i>	Induktanz - Dreiphasennetz für 37 kW
<b>IR 3-055</b>	Induttanza di rete trifase per 45 - 55 kW	<i>AC input three phase choke for 45 - 55 kW</i>	Induktanz - Dreiphasennetz für 55 - 45 kW
<b>IR 3-090</b>	Induttanza di rete trifase per 75 - 90 kW	<i>AC input three phase choke for 75 - 90 kW</i>	Induktanz - Dreiphasennetz für 75 kW
<b>IR 3-160</b>	Induttanza di rete trifase per 110 - 132 - 160 kW	<i>AC input three phase choke for 110 - 132-160 kW</i>	Induktanz - Dreiphasennetz für 110 - 132 - 160 kW
<b>IU 3-022</b>	Induttanza di uscita trifase per 22 kW	<i>Output three phase choke 22 kW</i>	Induktanz - dreiphasiger Ausgang für 22 kW
<b>IU 3-022</b>	Induttanza di uscita trifase per 22 kW	<i>Output three phase choke 22 kW</i>	Induktanz - dreiphasiger Ausgang für 22 kW
<b>IU 3-030</b>	Induttanza di uscita trifase per 30 kW	<i>Output three phase choke 30 kW</i>	Induktanz - dreiphasiger Ausgang für 30 kW
<b>IU 3-037</b>	Induttanza di uscita trifase per 37kW	<i>Output three phase choke 37 kW</i>	Induktanz - dreiphasiger Ausgang für 37 kW
<b>IU 3-055</b>	Induttanza di uscita trifase per 45 - 55 kW	<i>Output three phase choke 45 - 55 kW</i>	Induktanz - dreiphasiger Ausgang für 55 - 45 kW
<b>IU 3-090</b>	Induttanza di uscita trifase per 75 - 90 kW	<i>Output three phase choke 75 - 90 kW</i>	Induktanz - dreiphasiger Ausgang für 90 - 75 kW
<b>IU 3-160</b>	Induttanza di uscita trifase per 110 - 132 - 160 kW	<i>Output three phase choke 110 - 132 - 160 kW</i>	Induktanz - dreiphasiger Ausgang für 110 - 132 - 160 kW

**5.4 DIMENSIONI**
**5.4 DIMENSIONS**
**5.4 MASSE**


Modello / Model / Modell	A	B	C
T 220	309	489	268
T 300	309	489	308
T 370	309	489	308
T 450	376	564	308
T 550	376	564	308
T 750	509	741	297.5
T 900	509	909	297.5
T 1100	509	909	297.5
T 1320	509	909	297.5
T 1600	509	965	442
T 2000	509	965	442

**6.0 RESISTENZE DI FRENATURA**
**6.0 BRAKE RESISTORS**
**6.0 BREMSWIDERSTÄNDE**

Modello / Model / Modell	R [ohm]	Power [Watt]	A	B	D	IP	Fig.
RRE 0,8-100R	100	80	112	30	25	54	1
RRE 2-100R	100	200	309	30	25	54	1
RRE 3,5-75R	75	350	160	80	20	54	2
RRE3,5-100R	100	350	160	80	20	54	2
RRE 13-30R	30	1300	240	80	20	54	2
RRE 13-50R	50	1300	240	80	20	54	2
RRE 13-70R	70	1300	240	80	20	54	2
RRE 22-28R	28	2200	506	107	300	23	3
RRE 40-15R4	15.4	4000	626	107	300	23	3
RRE 40-11R6	11.6	4000	626	107	300	23	3
RRE 80-7R7	7.7	8000	626	197	300	23	3

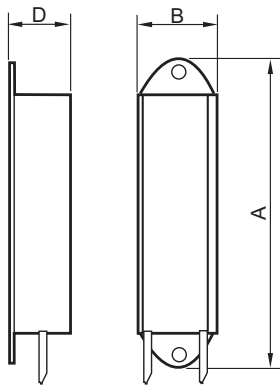
**6.1 DIMENSIONI**
**6.1 DIMENSIONS**
**6.1 MASSE**


Fig. 1

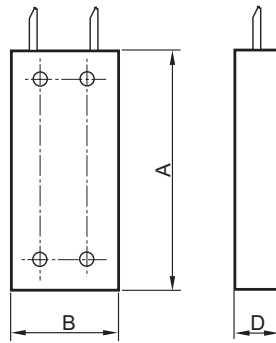


Fig. 2

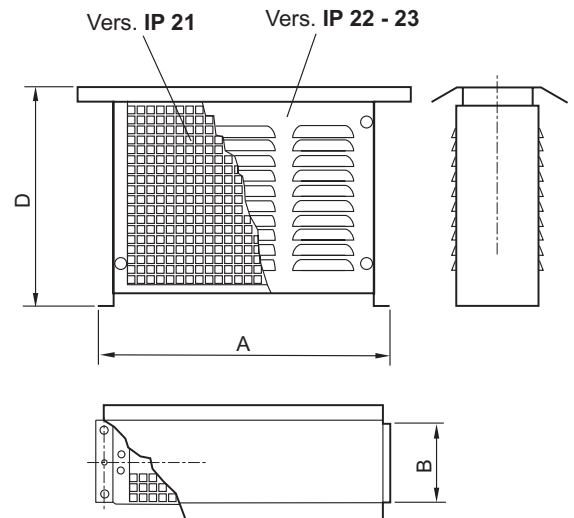
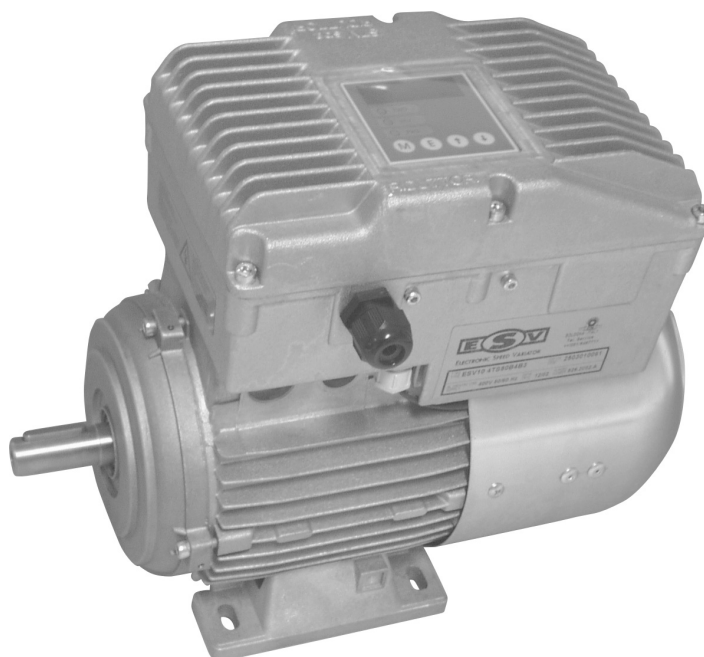


Fig. 3

				Pag. Page Seite
1.1	Presentazione del prodotto	<i>Product presentation</i>	Produkt beschreibung	D2
1.2	Curva di coppia	<i>Torque curve</i>	Drehmomentkurve	D3
1.3	Designazione ESV	<i>Designation ESV</i>	ESV-bezeichnung	D3
1.4	Tabella configurazioni ES	<i>ESV configuration table</i>	ESV-konfigurationstabelle	D4
1.5	Potenza nominale	<i>Nominal power</i>	Nennleistung	D4
1.6	Caratteristiche elettriche	<i>Electrical Characteristics</i>	Elektrische Eigenschaften	D5
1.7	Accessori e ricambi	<i>Accessories and spare parts</i>	Zubehör und ersatzteile	D6
1.8	Dimensioni	<i>Dimension</i>	Abmessungen Und Bauformen	D7
1.9	Installazione, messa in servizio, uso e manutenzione	<i>Installation, start up, use and maintenance</i>	Installation, Inbetriebnahme, Gebrauch und Instandhaltung	D8
1.10	Direttive CEE - marcatura CE	<i>EC directives-CE mark</i>	EC Richtlinien – CE Marckierung	D8



## 1.1 Presentazione del prodotto

La STM s.p.a., da sempre propositiva verso il mercato, è stata pioniera nel connubio tra elettronica e meccanica realizzando l'ESV Electronic Speed Variator.

L'ESV "the new intelligent system", risponde ad un mercato esigente e selettivo combinando le prestazioni del variatore meccanico con l'affidabilità e soprattutto la flessibilità del controllo elettronico.

Lo speciale controllo elettronico consente la coppia costante pari al valore nominale del motore e scorrimenti di velocità estremamente bassi su tutto il campo di velocità.

La tastiera integrata permette la configurazione dell'ESV e le regolazioni con estrema facilità, il display consente di visualizzare in modo semplice la velocità e variabili del controllo.

Il motore elettrico è protetto elettronicamente da sovraccarichi e sovratemperature segnalate sul display con appositi codici di errore.

Il controllo di velocità integrato permette di ridurre lo spazio sul quadro di controllo e ne semplifica il suo allacciamento.

L'assenza di cablaggio tra motore e controllo elettronico elimina i problemi di compatibilità elettromagnetica e di instabilità elettrica riducendo così la messa in servizio al solo allacciamento in rete.

Il variatore elettronico è un prodotto progettato per l'ambiente industriale e possiede le seguenti caratteristiche:

- prestazioni meccaniche comparabili al variatore meccanico
- grado di protezione IP55
- soddisfa le linee guida della direttiva EU sulla compatibilità elettromagnetica EMC (filtro di rete incorporato di serie) in tema di emissione e immunità dei disturbi
- conforme alla direttiva EU sulla bassa tensione LVD e norme tecniche armonizzate sulla sicurezza elettrica
- facile interfacciabilità con i sistemi di controllo come PLC o controlli a microprocessore grazie al sistema di ingressi e uscite digitali e analogiche disponibili
- interfaccia seriale:  
RS485 (MODBUS)  
CAN BUS (CAN OPEN, DEVICE NET)  
PROFIBUS (PROFIBUS DP, PROFIDRIVE)

## 1.1 Product Presentation

*S.T.M. S.p.A., always innovative towards the market, has been a pioneer in the union between electronics and mechanics by realising ESV Electronic Speed Variator.*

*ESV the new intelligent system, meets the requirements of an exigent and selective market by combining the performances of the mechanical variator and the reliability and most of all flexibility of the electronic control.*

*The special electronic control enables the constant torque equal to the nominal value of the motor and very low speed sliding all over the speed field.*

*The built-in digital keyboard allows easy and quick ESV configuration and setting. The built-in display enables to display speed and control settings extremely easily.*

*The electronic motor is protected from overloads and over-temperatures which are displayed with appropriate error codes.*

*The integrated speed control enables reduction of control panel dimension and makes installation easier.*

*The absence of wiring between the motor and the electronic control avoids electromagnetic compatibility problems and electric instability, by simplifying the commissioning.*

*The electronic variator is a product which suite to the industrial environment and has the following characteristics:*

- *mechanical performances comparable to mechanic variator*
- *protection degree IP55*
- *satisfy the guidelines of CEE directive on electromagnetic compatibility EMC (serial incorporated network filter) on the sending out and immunity of the bothers*
- *in conformity with CEE directive on low voltage LVD and with the technical norms in force on electric safety*
- *easy to interface with control systems such as PLC or microprocessors controls, thanks to the availability of an appropriate system of digital and analog inputs and outputs*
- *serial interface:  
RS485 (MODBUS)  
CAN BUS (CAN OPEN, DEVICE NET)  
PROFIBUS (PROFIBUS DP, PROFIDRIVE)*

## 1.1 Produktbeschreibung

Schon immer auf die Bedürfnisse des Marktes ausgerichtet, war die STM spa auch bei der Realisierung des Electronic Speed Variator führend, indem Elektronik und Mechanik kombiniert wurden.

Der ESV vereint die Leistungen eines mechanischen Verstellgetriebes mit der Zuverlässigkeit und vor allem mit der Flexibilität elektronischer Regeleinheiten.

Die elektronische Regeleinheit ermöglicht ein konstantes Drehmoment gleich dem Nennwert des Motors und sehr geringe Drehzahlschwankungen im gesamten Drehzahlbereich.

Die integrierte Bedieneinheit erlaubt eine einfache und schnelle Programmierung von ESV. Der digitale Anzeiger erlaubt eine einfache Anzeigung des Geschwindigkeites und der Steuerungsregelungen.

Der Elektromotor ist elektronisch vor Überlastung und Überhitzung geschützt, die auf dem Anzeiger mit vorgesehene Fehlercoden angezeichnet sind.

Die integrierte Drehzahlkontrolle reduziert den Platzbedarf im Schaltschrank und vereinfacht den Anschluß.

Das Fehlen einer Verkabelung zwischen Motor und Kontrolleinheit beseitigt die Probleme der elektro-magnetischen Kompatibilität und der elektrischen Instabilität, wodurch sich die Inbetriebnahme auf den reinen Netzanschluss reduziert

Der elektronische Drehzahlwandler ist ein Produkt, welches für den industriellen Einsatz konstruiert wurde und die folgenden Eigenschaften besitzt:

- Mechanische Leistungen vergleichbar mit dem mechanischen Drehzahlwandler
- Schutzgrad IP55
- erfüllt die Richtlinien der CEE-Vorschrift hinsichtlich der elektromagnetischen Kompatibilität EMC (serienmäßig eingebauter Netzfilter) in Bezug auf Störungsemission und -immunität.
- entspricht der CEE-Vorschrift hinsichtlich Niederspannung LVD und den auf die elektrische Sicherheit abgestimmten technischen Normen
- einfache Schnittstellenbildung mit Kontrollsystemen wie SPS oder Mikroprozessorkontrollen dank an einem digital und analog Eingangs und Ausgangssystem
- serienschnittstelle:  
RS485 (MODBUS)  
CAN BUS (CAN OPEN, DEVICE NET)  
PROFIBUS (PROFIBUS DP, PROFIDRIVE)



### 1.2 Curva di coppia

La caratteristica coppia-velocità ha la coppia massima costante  $T_n$  in servizio continuo (area S1) per tutto il campo di velocità.

In condizione di sovraccarico la coppia arriva al 200% di  $C_n$  con un servizio ciclico (area S6).

Oltre il 200% di  $C_n$  si ha il blocco istantaneo dell'ESV.

Oltre la velocità nominale si può lavorare a potenza costante.

In figura la caratteristica coppia-velocità per la versione 4 poli.

### 1.2 Torque curve

The feature torque-speed has the constant maximum torque in continuous service for all speed field (S1 area).

In overload conditions the torque reaches up to the 200% of  $C_n$  in presence of cyclic duty (area S6).

Over 200% of  $C_n$  is the immediate lock.

Over the nominal speed the product can be operated at constant power.

In figure the characteristic torque-speed for 4 poles version.

### 1.2 Drehmomentkurve

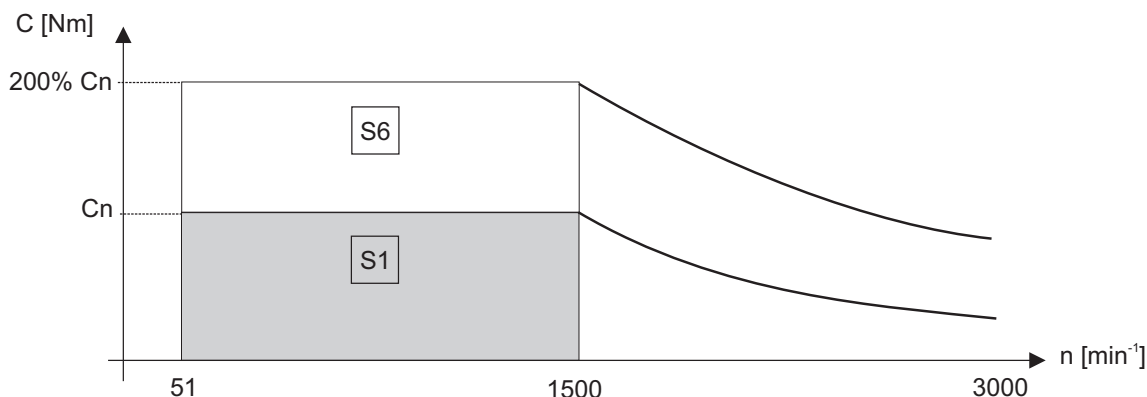
Die Drehmoment-Drehzahl-Kennlinie hat bei kontinuierlichem Betrieb (Bereich S1) im gesamten Drehzahlbereich ein konstantes maximales Drehmoment  $T_n$ .

Bei Überlast erreicht das Drehmoment 200% von  $C_n$  (Bereich S6).

Über 200% von  $C_n$  wird der ESV sofort abgeschaltet.

Über die Nominalgeschwindigkeit arbeitet der ESV mit Dauerleistung.

In der fig. kann man das diagram das drehmoment-geschwindigkeit 4 poligen sehen.



### 1.3 Designazione ESV

Le potenze disponibili vanno da 0.37 kW a 7.5 kW.

I motori hanno le polarità come in tabella.

I tipi di fissaggio sono B3, B5, B14 o nelle forme miste B3/B5, B3/B14, nelle dimensioni standard riportate in tabella, oppure ridotte.

Il grado di protezione standard è IP55, su richiesta si può avere la versione IP65.

Nella versione autofrenante è installato un freno elettromeccanico in corrente continua.

### 1.3 ESV Designation

The available sizes are included between 0.37 kW and 7.5 kW.

The polarities of the motors are like the table.

The fixing types are B3, B5, B14 or B3/B5, B3/B14 in standard sizes or reduced (see options table).

The standard protection degree is IP55, upon request it is possible to supply the type IP65.

In brake motors type has been installed an electromechanical brake in direct current.

### 1.3 ESV - Bezeichnung

Die erhältlichen Größen bei 0,37 kW und 7,5 kW.

Die Motoren sind zwei- oder vierpolig.

Die Befestigungstypen sind B3, B5, B14 in den in Tabelle angegebenen Standardabmessungen oder reduzierte Anschlußmaße (siehe Tabelle unter "Optionen").

Der Standard Schutzgrad ist IP55, auf Anfrage ist die Version IP65 erhältlich.

Die ESV in Bremsmotor-Ausführung besitzen eine elektromagnetische Gleichstrombremse.

Tipo Type Typ	Grandezza Size Größe	Alimentazione Supply Netzspannung	Dimensione Dimension Dim.	n° poli n° poles Polig	Forma Shape Form.	Freno Brake Bremsen	Protezione Protection IP- Grad.	Isolamento Isolation Isolierungsklasse	Tropicalizz. Tropicaliz. Tropentaugl.
---------------------	----------------------------	---	---------------------------------	------------------------------	-------------------------	---------------------------	---------------------------------------	--	---

**ESV 10 4TA 80B 4 B14 FCC IP55 H T**



#### Tipi di alimentazione / Supply / Netzspannung

<b>2TS</b>	Trifase standard (230 V)	Standard three phase (230 V)	Standard Drehstrom (230 V)
<b>2TA</b>	Trifase autofrenante (230 V)	Tbrake motor three phase (230 V)	Bremsmotor Drehstrom (230 V)
<b>4TS</b>	Trifase standard (400 V)	Standard three phase (400 V)	Standard Drehstrom (400 V)
<b>4TA</b>	Trifase autofrenante (400 V)	Tbrake motor three phase (400 V)	Bremsmotor Drehstrom (400 V)

1.4 Tabella configurazioni ESV

1.4 ESV configuration table

1.4 ESV-konfigurationstabelle

ESV				Tipo motore Motor Motor			Opzioni / Options / Optionen						
Grand. Size Grösse	Alimentazione Supply Netzspannung		Dimensione Dimension Dim.	n° poli n° poles Polig	Forma Shape Form	Flange IEC ridotte IEC reduced flanges Reduz. Anschl.		Alb. mot. Shaft motor Reduz. Welle	Freno Brake Bremsen	Protezione Protection IP Grad	Isolamento Isolation Isolierungskl.	Tropicaliz. Tropicaliz. Tropentaugl.	
						B14	B5						
ESV TRIFASE ESV THREE PHASE ESV DREHTROM	<b>05</b>	2TS	2TA	71A	2	B3 B5 B14 B6(=B3/B5) B8(=B3/B14)	56	—	9	FCC	IP 65	H	T
		4TS	4TA	71B	4		63	63	11				
	<b>10</b>	2TS	2TA	80A	2		63	63	11				
		4TS	4TA	80B	4		71	71	14				
	<b>15</b>	2TS	2TA	80B	2		71	71	14				
		4TS	4TA	90S	4		80	80	19				
	<b>20</b>	2TS	2TA	90S	2		80	80	19				
		4TS	4TA	90L	4		80	80	19				
	<b>30</b>	2TS	2TA	90L	2		80	80	24				
		4TS	4TA	100A	4		90	90	24				
	<b>40</b>	2TS	2TA	100A	2		90	90	24				
		4TS	4TA	100B	4		90	90	24				
	<b>50</b>	2TS	2TA	112A	2		90	90	24				
		4TS	4TA	112A	4		90	90	24				
	<b>75</b>	4TS	4TA	132S	2		90	90	24				
				132S	4		—	100	28				
	<b>100</b>	4TS	4TA	132SL	2		—	100	28				
				132M	4			100	28				

Peso del prodotto imballato (Kg)

	ESV								
	05	10	15	20	30	40	50	75	100
<b>4TS</b>	9.5	13.7	17.5	21.8	29.8	32.4	43	63	65
<b>2TS</b>	9.5	14.7	16.5	20.8	38.5	41.2	52.1	—	—

1.5 Potenza nominale

1.5 Nominal power

1.5 Nennleistung

4 Poli / Poles / Polig		2 Poli / Poles / Polig	
Tipo / Type / Typ	Potenza nominale Nominal power Nennleistung [kW]	Tipo / Type / Typ	Potenza nominale Nominal power Nennleistung [kW]
<b>71B</b>	0.37	<b>71A</b>	0.37
<b>80B</b>	0.75	<b>80A</b>	0.75
<b>90S</b>	1.1	<b>80B</b>	1.1
<b>90L</b>	1.5	<b>90S</b>	1.5
<b>100A</b>	2.2	<b>90L</b>	2.2
<b>100B</b>	3	<b>100A</b>	3
<b>112A</b>	4	<b>112A</b>	4
<b>132S</b>	5.5	<b>132S</b>	5.5
<b>132M</b>	7.5	<b>132SL</b>	7.5

## 1.6 Caratteristiche elettriche

## 1.6 Electrical Characteristics

## 1.6 Elektrische Eigenschaften

4 poli poles poligen	ESV 05	ESV 10	ESV 15	ESV 20	ESV 30	ESV 40	ESV 50	ESV 75	ESV 100
<b>Caratteristiche meccaniche e ambientali / Mechanical and environmental characteristics / Mechanische Kenndaten und Umgebungsbedingungen</b>									
<b>P<sub>n</sub></b> [kW]	0.37	0.75	1.1	1.5	2.2	3.0	4	5.5	7.5
<b>C<sub>n</sub></b> [Nm]	2.5	5.0	7.4	10.0	14.7	20	27	37	49
<b>C<sub>s</sub></b>	Da zero alla coppia nominale / From zero to the rated torque / Von Null bis zum Nenndrehmoment								
<b>C<sub>e</sub></b>	Fino al 200% della coppia nominale C <sub>n</sub> / Up to 200% of the rated torque C <sub>n</sub> / Bis 200 % des Nenndrehmoments C <sub>n</sub>								
<b>C<sub>max</sub></b>	200% della coppia nominale C <sub>n</sub> / 200% of the rated torque C <sub>n</sub> / 200 % des Nenndrehmoments C <sub>n</sub>								
<b>n</b>	51 - 1500								
<b>Δn</b>	100 rpm fino alla coppia nominale / 100 rpm up to the rated torque / 100 U/min bis zum Nenndrehmoment								
<b>T</b> [°C]	0° - 40°								
<b>Caratteristiche elettriche 4T / 4T Electrical characteristics / Stromwerte 4T</b>									
Alimentazione Supply Nennspannung	380 V - 15% / 460 + 10% - 50/60 Hz								
<b>I<sub>n</sub></b> [A] ms	2.1	3.5	5	6	8	10	13	16	21
<b>Caratteristiche elettriche 2T / 2T Electrical characteristics / Stromwerte 2T</b>									
Alimentazione Supply Nennspannung	220 V - 15% / 240 + 10% - 50/60 Hz								
<b>I<sub>n</sub></b> [A] ms	2.5	5	8	9	11	18	25		
<b>Caratteristiche elettriche 2M / 2M Electrical characteristics / Stromwerte 2M</b>									
Alimentazione Supply Nennspannung	220 V - 15% / 240 + 10% - 50/60 Hz								
<b>I<sub>n</sub></b> [A] ms	4.5	9	12	16	20	32	44		
<b>EMC</b>	Incorporato / Incorporated / Eingebaut								
<b>IP</b>	IP 55								

## Simbologia

## Symbology

## Verwendete Symbole

<b>P<sub>n</sub></b>	[kW]	Potenza nominale	<i>Nominal power</i>	Nennleistung
<b>C<sub>n</sub></b>	[Nm]	Coppia nominale	<i>Nominal torque</i>	Nenndrehmoment
<b>C<sub>s</sub></b>	[Nm]	Coppia erogabile in servizio continuo (S1)	<i>Distributable in continuous service (S1)</i>	Lieferbares Drehmoment bei kontinuierlichem Betrieb (S1)
<b>C<sub>e</sub></b>	[Nm]	Coppia erogabile in servizio ciclico o non continuo (S6)	<i>Distributable in overload condition (S6)</i>	Lieferbares Drehmoment bei überlast (S6)
<b>C<sub>MAX</sub></b>	[Nm]	Coppia massima	<i>Maximum torque</i>	Maximales Drehmoment
<b>n</b>	[min <sup>-1</sup> ]	Velocità	<i>Speed</i>	Drehzahl
<b>Δn</b>	[min <sup>-1</sup> ]	Massimo errore di velocità	<i>Maximum speed error</i>	Max. Drehzahlabweichung
<b>t</b>	[C°]	Temperatura ambiente	<i>Environment temperature</i>	Umgebungstemperatur
<b>I<sub>n</sub></b>	[A]	Corrente nominale	<i>Nominal current</i>	Nennstrom
<b>EMC</b>		Filtro rete EMC	<i>EMC filter</i>	EMC-Netzfilter
<b>IP</b>		Grado di protezione degli equipaggiamenti rispetto a solidi e liquidi	<i>Equipment protection level from solids and liquids</i>	Schutzart der Ausrüstungen gegenüber Festkörpern und Flüssigkeiten
<b>m</b>	[Kg]	Massa	<i>Mass</i>	Masse

### 1.7 Accessori e ricambi

- Cavi di remotazione

Cavo / cable / kabel	L = 1mt	L = 3 mt	L = 5 mt	L = 10 mt
IO1	X	X	X	X
IO1 + IO2	X	X	X	X
LINK - FB	X	X	X	X
DISPLAY - M	X	X	X	X

#### • Tastiera ausiliaria Flash TST

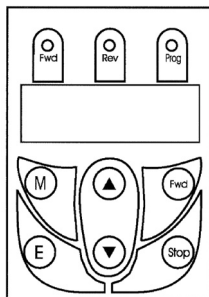
La dimensione del foro passante è 87x65  
La dimensione della facciata è 104x75

### 1.7 Accessories and spare parts

- Interface Cables

#### • Auxiliary keyboard Flash TST

Dimensions of trough hole 87x65  
Front dimensions 104x75



### 1.7 Zubehör und ersatzteile

- Zubehör Kabel Zur Externen

#### • Hilfstastatur Flash TST

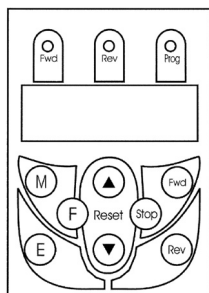
Abmessungen den durch Bohrung 87x65  
Abmessungen den vorderseitig 104x75

#### • Tastiera ausiliaria Flash LNK

La dimensione del foro passante è 87x65  
La dimensione della facciata è 104x75

#### • Auxiliary keyboard Flash LNK

Dimensions of trough hole 87x65  
Front dimensions 104x75



#### • Hilfstastatur Flash LNK

Abmessungen den durch Bohrung 87x65  
Abmessungen den vorderseitig 104x75

#### • Chiave di programmazione KM-PRGE

#### • Programming key KM-PRGE

#### • Parameterschlüssel KM-PRGE



#### • Resistenze di frenatura

#### • Brake Resistance

#### • Bremswiderstand

Modello / Model / Geratetyp	Valore / Value / Wert
ESV 05 4TS / ESV 10 4TS	RRE2 - 100R
ESV 15 4TS / ESV 20 4TS	RRE2 - 100R
ESV 30 4TS / ESV 40 4TS / ESV 50 4TS	RRE3.5 - 75R
ESV 75 4TS	RRE6 - 50R
ESV 100 4TS	RRE6 - 25R

- Scheda interfaccia RS485 - MODBUS
- Scheda interfaccia CANBUS
- Scheda interfaccia PROFIBUS

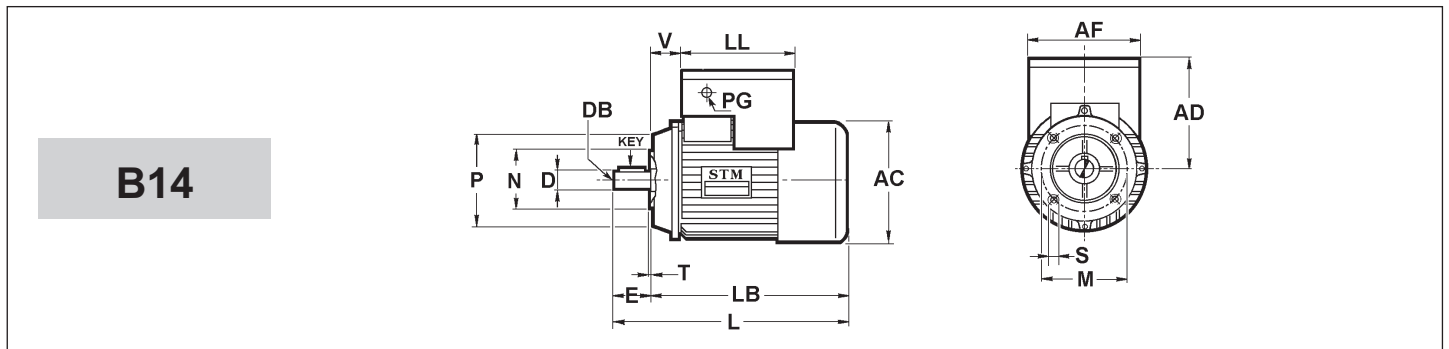
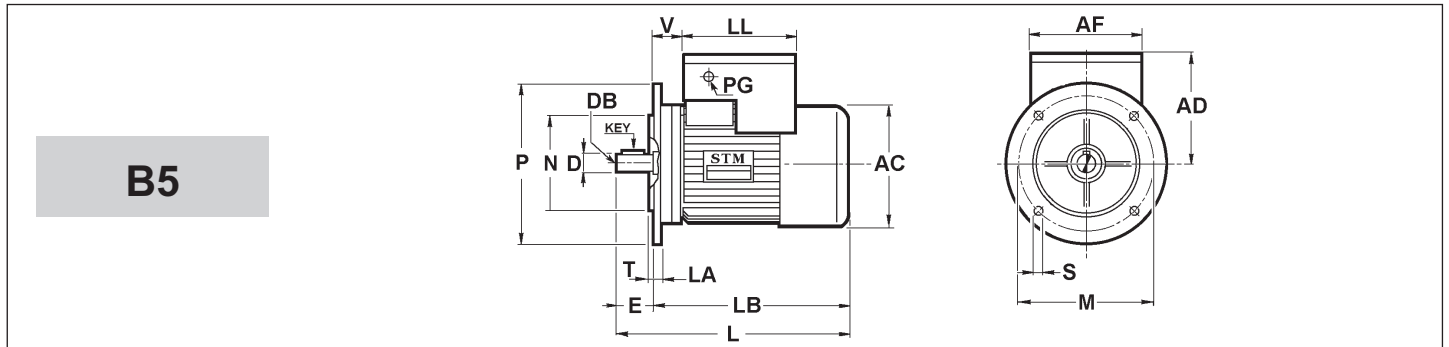
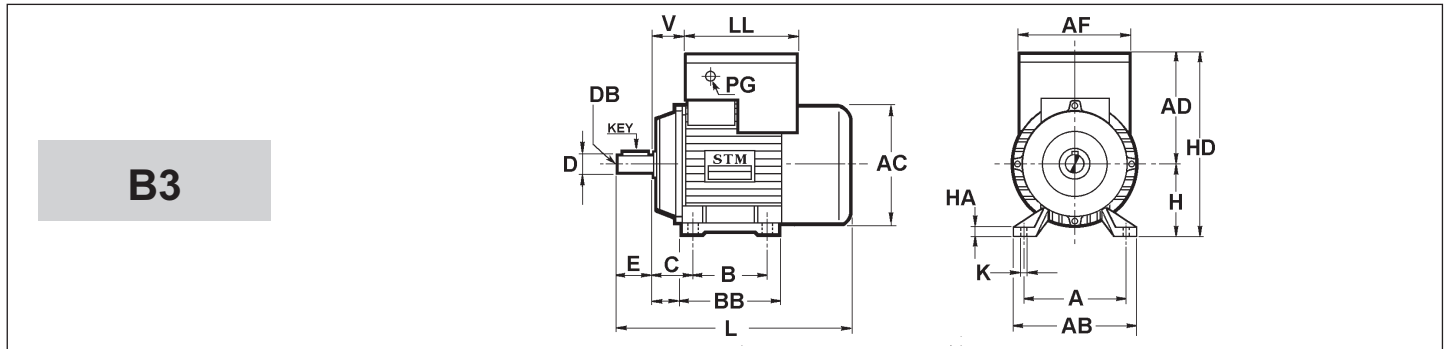
- Interface board RS485 - MODBUS
- Interface board CANBUS
- Interface board PROFIBUS

- Schnittstelle karte RS485 - MODBUS
- Schnittstelle karte CANBUS
- Schnittstelle karte PROFIBUS

1.8 Dimensioni

1.8 Dimensions

1.8 Abmessungen und Bauformen



	B3 - B5 - B14												B5							
	AC	AD	AF	D	DB	E	L	L*	LL	PG	V	Key	LA	LB	LB*	M	N	P	S	T
<b>71</b>	140	173	139	14	M5	30	350	350	220	M20	17	5x5x20	10	320	320	130	110	160	9	3.5
<b>80</b>	159	184	139	19	M6	40	386	386	220	M20	36	6x6x30	12	346	346	165	130	200	11	3.5
<b>90S</b>	176	187	181	24	M8	50	410	482	227	M20	29	8x7x40	12	360	432	165	130	200	11	3.5
<b>90L</b>	176	187	181	24	M8	50	438	507	227	M20	29	8x7x40	12	388	457	165	130	200	11	3.5
<b>100</b>	195	215	207	28	M10	60	476	550	297	M20	29	8x7x40	14	416	490	215	180	250	14	4
<b>112</b>	219	230	207	28	M10	60	501	584	297	M20	29	8x7x40	14	441	524	215	180	250	14	4
<b>132S</b>	258	334	250	38	M12	80	588	658	400	M25	40	10x8x70	14	508	578	265	230	300	14	4
<b>132M</b>	258	334	250	38	M12	80	625	695	400	M25	40	10x8x70	14	545	615	265	230	300	14	4

	B3											B14							
	A	AB	B	BB	C	E1	H	HA	K	HD	LB	LB*	M	N	P	S	T		
<b>71</b>	112	135	90	109	45	35.5	71	10	7	244	320	320	85	70	105	M6	3.5		
<b>80</b>	125	155	100	125	50	37.5	80	12	9	264	346	346	100	80	120	M6	3.5		
<b>90S</b>	140	170	100	128	56	42	90	13	9	277	360	432	115	95	140	M8	3.5		
<b>90L</b>	140	170	125	154	56	41.5	90	13	9	277	388	457	115	95	140	M8	3.5		
<b>100</b>	160	192	140	165	63	50.5	100	14	12	315	416	490	130	110	160	M8	4		
<b>112</b>	190	220	140	180	70	50	112	15	12	342	441	524	130	110	160	M8	4		
<b>132S</b>	216	260	140	180	89	60	132	16	12	466	508	578	165	130	200	M10	4		
<b>132M</b>	216	260	178	216	89	60	132	16	12	466	545	615	165	130	200	M10	4		

L\*, LB\*: dimensioni relative alla versione autofrenante / dimensions of brake motors type / Abmessungen Bremsmotor

## 1.9 Installazione, messa in servizio, uso e manutenzione

Gli aspetti relativi alle modalità di installazione, messa in servizio, uso e manutenzione dell'ESV sulle sue diverse tipologie e configurazioni sono riportati sul "manuale di uso e manutenzione".

Il manuale è fornito allegato al prodotto ed è relativo alla sua configurazione.



Prima di installare, mettere in servizio o mantenere qualunque tipo di ESV in qualunque configurazione consultare il manuale allegato.

Qualora sia stato smarrito lo stesso richiedere copia all'ufficio tecnico STM.

## 1.9 Installation, start up, use and maintenance

*The modalities of ESV installation, start up, use and maintenance and its different features and configuration are listed in the "use and maintenance manual".*

*The manual is supplied together with the product and it is about its configuration.*



*Before starting the installation, the start up or maintenance of any kind and configuration of ESV look the manual up enclosed.*

*In case it has been lost please ask a copy to S.T.M. Technical Dept.*

## 1.9 Installation, Inbetriebnahme, Gebrauch und Instandhaltung

Die verschiedenen Ausführungen und Konfigurationen bezüglich Installation, Inbetriebnahme, Gebrauch und Instandhaltung des ESV sind im „Gebrauchs- und Instandhaltungshandbuch“ aufgeführt. Das Handbuch ist typspezifisch und wird zusammen mit dem Produkt ausgeliefert



Für jede Ausführung des ESV ist vor Installation, Inbetriebnahme oder Instandhaltungsmaßnahmen irgendwelcher Art das jeweils beigefügte Handbuch durchzulesen.

Sollte das Handbuch nicht mehr vorhanden sein, so fordern Sie bitte im technischen Büro von STM eine neue Ausführung an.

## 1.10 Direttive CEE- marcatura CE

### Direttiva bassa tensione 73/23/CEE

Gli ESV sono conformi alle prescrizioni della direttiva bassa tensione.

### Direttiva compatibilità elettromagnetica 89/336/CEE

Gli ESV sono conformi alle specifiche della direttiva di compatibilità elettromagnetica.

### Direttiva macchine 89/392/CEE

Gli ESV non sono macchine ma organi da installare o da assemblare nelle macchine.

### Marcatura CE, dichiarazione del fabbricante e dichiarazione di conformità

Gli ESV hanno marcatura CE

Questa marcatura indica la loro conformità alla direttiva bassa tensione e alla direttiva compatibilità elettromagnetica.

Su richiesta STM può fornire la dichiarazione di conformità dei prodotti e la dichiarazione del fabbricante secondo la direttiva macchine

## 1.10 EC directives - CE mark

### Low voltage directive 73/23 EEC

*The ESV meet the specification of the low voltage directive.*

### EMC directive 89/336/EEC

*The ESV correspond to the specifications of the EMC directive.*

### Machine directive 89/392/EEC

*The ESV are not application-ready in reference to the above mentioned directive on individual machines.*

*It is exclusively for installation into a machine or for assembly into a machine.*

### CE mark, conformity declarations and manufacturer's declaration

*ESV carry the CE mark. Herewith is conformity to the low voltage directive documented.*

*STM supplies on request both the conformity declarations and the manufacturer declaration to the machine directives.*

## 1.10 EC Richtlinien –CE Marckierung

### Niederspannungsrichtlinie 73/23/EEC.

Die ESV ist erfüllen die Vorschriften der Niederspannungsrichtlinie.

### EMV-Richtlinie 89/336/EEC

Der ESV entsprechen den Vorschriften der EMV-richtlinie.

### Maschinenrichtlinie 89/392 EEC

Der ESV ist Einzelmaschinen, sie sind nicht verwendungsfertig.

Er ist ausschliesslich zum Einbau in eine Maschine oder zum Zusammenbau zu einer Maschine bestimmt.

### CE-Markierung, Konformitäts- und Hersteller-Erklärung

Der ESV trage die CE-Markierung, womit die Konformität mit der Niederspannungsrichtlinie dokumentiert ist.

STM stellt auf Wunsch sowohl die Konformitätserklärung als auch die Herstellererklärung zu den maschinenrichtlinien zur verfügung.



**Tipi di servizio**

(secondo CEI EN 60034-1 / IEC 34-1)

Al fine di semplificare la scelta del motore da installare, vengono riportate le specifiche dei vari tipi di servizi più o meno gravosi in condizioni ambientali normali, così come sono definite nelle norme CEI EN 60034-1. Per i servizi da S3 a S8 compresi, il ciclo di riferimento è di 10 minuti complessivi.

**Types of duty**

(per CEI EN 60034-1 / IEC 34-1)

To simplify the choice of motor to install, below are the specifications of the various types of duty, more or less heavy-duty, as defined by the standard CEI EN 60034-1. For duties from S3 through S8, the reference cycle is a total of 10 minutes.

**Betriebsarten**

(nach CEI EN 60034-1 / IEC 34-1)

Um die Wahl des richtigen Motors zu erleichtern, werden nachfolgend die verschiedenen von der Norm CEI EN 60034-1 definierten Betriebsarten für mehr oder weniger schweren Einsatz unter normalen Umgebungsbedingungen beschrieben. Bei den Betriebsarten S3 bis S8 beträgt der Referenzzyklus insgesamt 10 Minuten.

**S1 - Servizio continuo:**

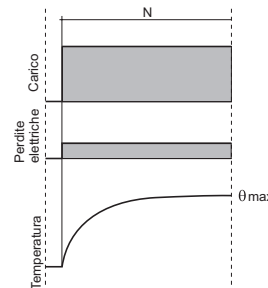
funzionamento del motore a carico costante per un periodo di tempo indefinito, comunque sufficiente a raggiungere l'equilibrio termico.

**S1 - Continuous duty:**

Steady load operation for an indefinite period, but sufficient to achieve a thermal balance.

**S1 - Dauerbetrieb:**

Betrieb des Motors mit konstanter Last über eine unbestimmte Zeit, die ausreichen muß, um das thermische Gleichgewicht zu erreichen.



**S2 - Servizio di durata limitata:**

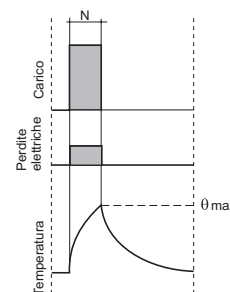
funzionamento del motore a carico costante per un periodo di tempo indefinito, comunque sufficiente a raggiungere l'equilibrio termico.

**S2 - Limited duty:**

Steady load operation for a limited time, insufficient to achieve a thermal balance, followed by a resting period sufficient to return the motor to ambient temperature.

**S2 - Kurzzeitbetrieb:**

Betrieb des Motors mit konstanter Last für eine begrenzte Zeit, die nicht ausreicht um das thermische Gleichgewicht zu erreichen, gefolgt von einer für die Abkühlung des Motors ausreichend langen Stillstandzeit.



**S3 - Servizio intermittente periodico:**

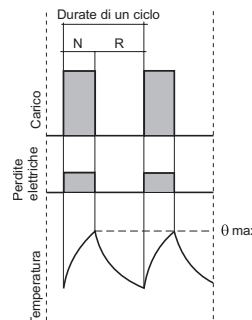
funzionamento del motore secondo un ciclo comprendente un periodo di tempo a carico costante (N) ed un periodo di tempo di riposo (R). La corrente di avviamento non influisce sulle temperature.

**S3 - Periodic intermittent duty:**

Motor operation according to a cycle that includes a steady load time (N) and a rest time (R). The starting current does not affect the temperature.

**S3 - Intervallbetrieb:**

Betrieb des Motors in einem Zyklus, der einen Betrieb mit konstanter Last (N) und eine Stillstandzeit (R) einschließt. Die Temperatur wird nicht vom Anlaufstrom beeinflusst.



**S4 - Servizio intermittente periodico con avviamenti che influenzano il riscaldamento del motore:**

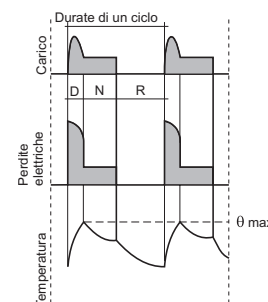
funzionamento del motore secondo un ciclo comprendente un tempo di avviamento notevole (D), un periodo di funzionamento a carico costante (N) e un periodo di riposo (R).

**S4 - Periodic intermittent duty with starting that affects motor heating:**

Motor operation according to a cycle that includes a considerable starting time (D), a period of operation at steady load (N), and a rest time (R).

**S4 - Intervallbetrieb mit Anlaufzeiten, die die Motortemperatur beeinflussen:**

Betrieb des Motors in einem Zyklus, der eine lange Anlaufzeit (D), einen Betrieb mit konstanter Last (N) und eine Stillstandzeit (R) einschließt.



**S5 - Servizio intermittente periodico con avviamento e frenata che influenzano il riscaldamento del motore:**

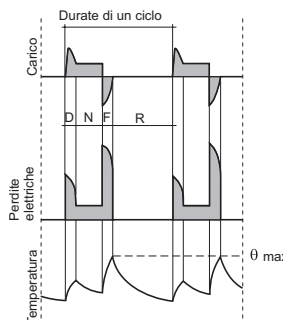
funzionamento del motore come S4 ma con l'aggiunta di una frenatura elettrica.

**S5 - Periodic intermittent duty with starting and braking that affect motor heating:**

Motor operation as for S4, but with the addition of electric braking.

**S5 - Intervallbetrieb mit Anlaufzeiten und Bremsungen, die die Motortemperatur beeinflussen:**

Betrieb des Motors wie unter S4, jedoch zuzüglich einer elektrischen Bremsung.





**S6 - Servizio ininterrotto periodico con carico intermittente:** funzionamento del motore secondo cicli identici comprendenti un periodo di funzionamento a carico costante ed un periodo a vuoto senza alcun tempo di riposo.

**S6 - Uninterrupted periodic duty with intermittent load:** Motor operation in identical cycles that include a period of operation at steady load and a no-load period, without any rest time.

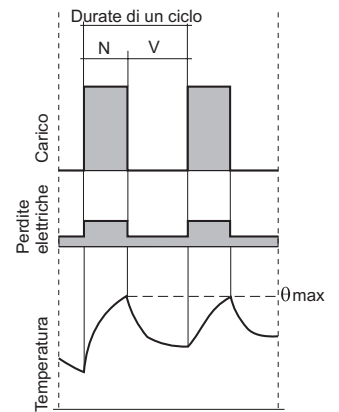
**S6 - Periodischer Dauerbetrieb mit intermittierender Belastung:** Betrieb des Motors mit identischen Betriebszyklen, die einen Betrieb mit konstanter Last und einen Betrieb im Leerlauf ohne Stillstandzeiten einschließen.

Rapporto di intermittenza

Intermittent ratio

Intermittenz Verhältnis

$$\frac{N}{N+V} \cdot 100\%$$



**S7 - Servizio intermittente periodico con frenata elettrica che influenza il riscaldamento del motore:** funzionamento del motore come il servizio S5 ma senza periodo di riposo.

**S7 - Periodic intermittent duty with electric braking that affects motor heating:** Motor operation as for S5, but without the rest time.

**S7 - Periodischer Intervallbetrieb mit elektrischer Bremsung, die die Motortemperatur beeinflusst:** Betrieb des Motors wie unter S5, jedoch ohne Stillstandzeiten.

Rapporti di intermittenza

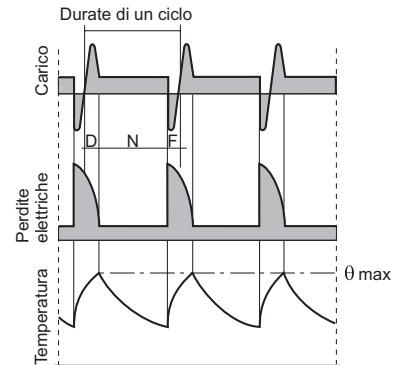
Intermittent ratios

Intermittenz Verhältnis

$$\frac{D+N_1}{D+N_1+F_1+N_2+F_2+N_3} \cdot 100\%$$

$$\frac{F_1+N_2}{D+N_1+F_1+N_2+F_2+N_3} \cdot 100\%$$

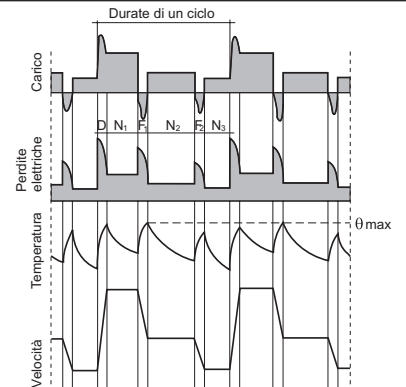
$$\frac{F_2+N_3}{D+N_1+F_1+N_2+F_2+N_3} \cdot 100\%$$



**S8 - Servizio ininterrotto periodico con variazioni periodiche della velocità e del carico:** funzionamento del motore secondo un ciclo comprendente un periodo di funzionamento a carico costante seguito da un altro con diverso carico costante e diversa velocità, non esiste periodo di riposo.

**S8 - Uninterrupted periodic duty with periodic speed and load changes:** Motor operation according to a cycle that includes a steady load operating period followed by another with a different load and different speed. No rest time is included.

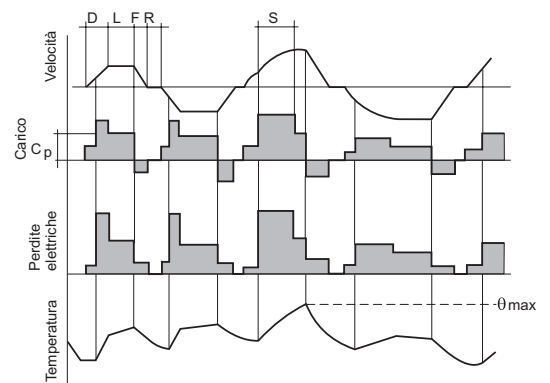
**S8 - Periodischer Dauerbetrieb mit regelmäßigen Änderungen der Drehzahl und der Belastung:** Betrieb des Motors in einem Zyklus, der zwei unterschiedliche konstante Lasten bei unterschiedlichen Drehzahlen ohne Stillstandzeiten umfaßt.



**S9 - Servizio con variazioni non periodiche di carico e di velocità:** servizio in cui generalmente il carico e la velocità variano in modo non periodico nel campo di funzionamento ammissibile. Questo servizio comprende sovraccarichi frequentemente applicati che possono essere largamente superiori ai valori di pieno carico.

**S9 - Duty with non-periodic changes in load and speed:** Duty in which the load and speed generally vary within the admissible operating range at no specific period. This duty includes frequently applied overloads that may be quite higher than fully loaded values.

**S9 - Dauerbetrieb mit unregelmäßigen Änderungen der Drehzahl und der Last:** Betrieb, bei dem sich die Drehzahl und die Belastung innerhalb der zulässigen Grenzen unregelmäßig ändern. Diese Betriebsart sieht häufige Überlastungen vor, die weit über den Vollastwerten liegen können.



<b>N=</b> Tempo di funzionamento a carico costante	Steady load operating time	Betriebszeit mit konstanter Last
<b>R=</b> Tempo di riposo	Rest time	Stillstandzeit
<b>D=</b> Tempo di avviamento o di accelerazione	Starting and accelerating time	Anlauf- oder Beschleunigungszeit
<b>F=</b> Tempo di frenatura elettrica	Electric braking time	Zeit der elektrischen Bremsung
<b>V=</b> Tempo di funzionamento a vuoto	No-load operating time	Leerlaufzeit
<b>F1 F2=</b> Tempo di frenata	Braking time	Bremszeit
<b>N1 N2 N3=</b> Tempo di funzionamento a carico costante	Steady load operating time	Betriebszeit unter konstanter Last
<b>θ max=</b> Temperatura massima raggiunta durante il ciclo	Maximum temperature achieved during the cycle	Während des Zyklus erreichte Höchsttemperatur
<b>L=</b> Tempo di funzionamento a carichi variabili	Operating time with variable loads	Betriebszeit mit variabler Last
<b>Cp=</b> Pieno carico	Full load	Vollast
<b>S</b> Tempo di funzionamento in sovraccarico	Overload operating time	Betriebszeit unter Überlastung





STANDARD

line

WEB SITE

WEB SITE

WEB SITE

**2D**

dwg - dxf

Selezione  
Prodotti  
Product  
Selection  
Vorwähler  
produziert

**3D**

iges - sat  
step - xb - xt

Download  
Cataloghi  
Download  
Catalogs  
Download  
Kataloge

**www.stmspa.com**

Servizi-Services-  
Dienstleistung:  
- Interactive STM  
- Web Order  
Management

Manuale Uso  
Manutenzione  
Manual Use  
Maintenance  
Bedienungsanleitung  
Wartung

Certificazioni  
Certifications  
Zertifizierung  
-QSA  
-ATEX

Parti Ricambio  
Spare Parts  
Ersatzteile



## Gestione Revisioni Cataloghi STM

## Managing STM Catalog Revisions

## Management Wiederholt Kataloge STM

## Codice Catalogo

## Catalog Code

## Katalogcode

	<b>STM_mod.CT18</b>	<b>I</b>	<b>GB</b>	<b>D</b>	<b>1</b>		
	N° Identificativo <i>Identification Number</i> Kennnummer	Identificativo Lingua - <i>Language</i> - Sprache  <b>I</b> - Italiano – <i>Italian</i> - Italienisch <b>GB</b> – Inglese – <i>English</i> - Englisch <b>D</b> – Tedesco – <i>German</i> - Deutsch			Indice di Revisione <i>Review</i> Bericht		

1) Ogni catalogo GSM in distribuzione è provvisto di un codice che lo identifica che è riportato nell'ultima pagina dei cataloghi e a piè pagina di tutte le pagine del catalogo stesso. Per verificare la revisione attualmente in vostro possesso è necessario guardare l'ultima cifra che compone il codice del catalogo:

1) *Each GSM catalogue is identified by a code printed on the last page and reported in the page footer. The last digit in the catalogue code identifies catalogue revision:*

1) Jeder, sich im Umlauf befindliche GSM-Katalog ist mit einer Identifikationsnummer versehen, der auf der letzten Seite und in den Fußnoten jeder einzelnen Seite aufgeführt ist. Um zu überprüfen, über welche Revision Sie im Augenblick verfügen, müssen Sie Bezug auf die letzte Ziffer der Katalognummer nehmen.

2) Il catalogo che contiene gli ultimi aggiornamenti è reperibile sul sito internet STM. Le modifiche riportate sono visibili consultando la tabella degli aggiornamenti che è allegata a questo documento. Sulle pagine che sono oggetto della modifica è riportato l'indice di revisione cambiato.

2) *Latest updated catalogues are available on STM's web site. Changes are listed in the updates table attached to this document. Any pages including a change are identified by a higher revision number.*

2) Der Katalog, der die letzten Aktualisierungen enthält, kann von der Internetseite der STM herunter geladen werden. Die eingefügten Neuerungen können der Tabelle der Aktualisierungen entnommen werden, die diesem Dokument anhängt. Die Seiten, die Änderungen unterlagen, sind mit der geänderten Revisionsnummer versehen.

3) Guardare con attenzione il simbolo inserito nella colonna "Classificazione Modifica".

3) *Pay attention to the symbol in the "Change Classification" column. This symbol signifies the category and significance of any changes*

3) Besonders auf das in die Spalte „Änderungskategorie“ eingefügte Symbol achten. In dieser Spalte wird das Symbol eingefügt, das für die Klasse der applizierten Änderungen steht.

In questa colonna sarà inserito un simbolo che determina una classificazione delle modifiche apportate.

Questo consente di identificare con estrema rapidità l'importanza della modifica apportata;

<b>Classificazione</b> <i>Classification</i> <b>Klasse</b>	<b>Definizione Specificante gli elementi di modifica</b> <i>Definition Change identifier</i> <b>Erklärende Definition der Änderungselemente</b>	<b>Simbolo Identificativo</b> <i>Symbol</i> <b>Identifikationssymbol</b>
Chiave <i>Key</i> Schlüssel	Uscita e immissione di un prodotto <i>Product issuance and marketing</i> Ausgabe und Einführung eines Produkts	
Importante <i>Major</i> Wichtig	Modifica che influenza gli ingombri/stato fornitura/installazione del prodotto <i>Change affecting overall dimensions/delivery condition/product installation</i> Änderung, die sich auf die Abmessungen/Lieferzustand/Produktinstallation auswirkt	
Secondaria <i>Minor</i> Sekundär	Modifica che riguarda traduzioni/impaginazioni/inserimento descrizioni <i>Change to translations/layout/captions</i> Änderung, die Übersetzungen/den Umbruch/eingefügte Beschreibungen betrifft	

4) Qualora risultasse una diversità di quote tra disegno **2D** – **3D** scaricato dal sito internet e tabella del catalogo è necessario consultare il nostro servizio tecnico.

4) *In the event the dimensions in the 2D – 3D drawing downloaded from our site differ from those indicated in the catalogue table, contact our Engineering.*

4) Diese ermöglicht ein schnelles Erfassen der Wichtigkeit der angesetzten Änderung.

## Attenzione


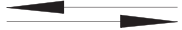
Verificare la revisione in vostro possesso e la tabella degli aggiornamenti apportati nella nuova revisione

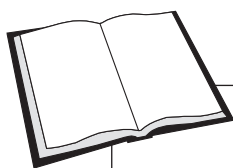
## Warning

*Check your catalogue revision status against the latest updates table.*

## Achtung

Überprüfen Sie die Revision, die sich in Ihren Händen befindet, und die Tabelle der in der neuen Revision eingefügten Aktualisierung.

			Aggiornamenti apportati	Updates made	Classificazione Modifica																																																																																												
Paragrafo Paragraph Paragraph	Pagina Page Seite	Indice Revisione Revision Index – Updates Inhalt Revision Aktualisierung	Descrizione	Description																																																																																													
	Tutte All	1.0	Tutte All	Nuova impaginazione catalogo e divisione catalogo in sezioni Sezione A Motori serie T... Sezione B Motori Serie VELA Sezione C INVERTER (STM DRIVE). Sezione D Variatori Elettronici ESV. Sezione E Errata Corrigge.																																																																																													
	27	1.0	A27	Tabella tensione/Frequenza: Grandezza 132 non 230/240 ma 230/400.	▼																																																																																												
	29	1.0	A29	Motori D-DA: non 2/4 – 2/8 ma 2/4 – 4/8	—																																																																																												
	33	1.0	A33	Sbagliato LOGO Electronic LINE	—																																																																																												
	43-45	1.0	A43-A45	Nella leva di sblocco errore nella descrizione posizione leva.	▼																																																																																												
	58	1.0	A58	Motore D160M i valori non sono: 9.5/5.0 ma 7.0/5.0. Motore D160L i valori non sono: 11.0/6.5 ma 10.0/7.0.	▼																																																																																												
	62-64	1.0	A62-A64	Sbagliata la velocità dei motori 4P non è 3000 ma 1500 rpm.	—																																																																																												
	74	1.0	A74	Motore TA... forma B3 la quota LB è sbagliata deve arrivare solo alla fine dello scudo.	▼																																																																																												
	90	1.0	B10	<table border="1"> <thead> <tr> <th>Tipo</th> <th>nn</th> <th>In</th> <th>cos<math>\phi</math></th> </tr> </thead> <tbody> <tr><td>56 A2</td><td>2700</td><td>0.36</td><td>0.75</td></tr> <tr><td>56 B2</td><td>2700</td><td>0.47</td><td>0.75</td></tr> <tr><td>63 A2</td><td></td><td>0.54</td><td></td></tr> <tr><td>71 A2</td><td></td><td>0.94</td><td></td></tr> <tr><td>71 B2</td><td></td><td>1.36</td><td></td></tr> <tr><td>80 A2</td><td></td><td>1.83</td><td></td></tr> <tr><td>80 B2</td><td></td><td>2.6</td><td></td></tr> <tr><td>90 S2</td><td></td><td>3.3</td><td></td></tr> <tr><td>100 L2</td><td></td><td>6.1</td><td></td></tr> <tr><td>132 A2</td><td></td><td></td><td></td></tr> <tr><td>(132 SA2)</td><td>2910</td><td>10.9</td><td>0.85</td></tr> <tr><td>132 SB2</td><td></td><td></td><td></td></tr> <tr><td>(132 M2)</td><td>2910</td><td>14.4</td><td>0.87</td></tr> <tr><td>160 MA2</td><td>2910</td><td></td><td>0.9</td></tr> <tr><td>160 MB2</td><td></td><td>27</td><td></td></tr> <tr><td>160 L2</td><td>2920</td><td>33.2</td><td></td></tr> <tr><td>180 M2</td><td>2925</td><td>39.4</td><td>0.89</td></tr> <tr><td>200 LA2</td><td>2940</td><td></td><td></td></tr> <tr><td>200LB2K</td><td></td><td>64</td><td></td></tr> <tr><td>225 M2K</td><td></td><td>78</td><td>0.9</td></tr> <tr><td>250 M2K</td><td>2940</td><td>93.0</td><td>0.92</td></tr> <tr><td>280 M2K</td><td></td><td>152</td><td>0.92</td></tr> </tbody> </table>	Tipo	nn	In	cos $\phi$	56 A2	2700	0.36	0.75	56 B2	2700	0.47	0.75	63 A2		0.54		71 A2		0.94		71 B2		1.36		80 A2		1.83		80 B2		2.6		90 S2		3.3		100 L2		6.1		132 A2				(132 SA2)	2910	10.9	0.85	132 SB2				(132 M2)	2910	14.4	0.87	160 MA2	2910		0.9	160 MB2		27		160 L2	2920	33.2		180 M2	2925	39.4	0.89	200 LA2	2940			200LB2K		64		225 M2K		78	0.9	250 M2K	2940	93.0	0.92	280 M2K		152	0.92	▼
Tipo	nn	In	cos $\phi$																																																																																														
56 A2	2700	0.36	0.75																																																																																														
56 B2	2700	0.47	0.75																																																																																														
63 A2		0.54																																																																																															
71 A2		0.94																																																																																															
71 B2		1.36																																																																																															
80 A2		1.83																																																																																															
80 B2		2.6																																																																																															
90 S2		3.3																																																																																															
100 L2		6.1																																																																																															
132 A2																																																																																																	
(132 SA2)	2910	10.9	0.85																																																																																														
132 SB2																																																																																																	
(132 M2)	2910	14.4	0.87																																																																																														
160 MA2	2910		0.9																																																																																														
160 MB2		27																																																																																															
160 L2	2920	33.2																																																																																															
180 M2	2925	39.4	0.89																																																																																														
200 LA2	2940																																																																																																
200LB2K		64																																																																																															
225 M2K		78	0.9																																																																																														
250 M2K	2940	93.0	0.92																																																																																														
280 M2K		152	0.92																																																																																														
	91	1.0	B11	<table border="1"> <thead> <tr> <th>Tipo</th> <th>nn</th> <th>In</th> <th>cos<math>\phi</math></th> </tr> </thead> <tbody> <tr><td>56 B4</td><td></td><td></td><td>0.6</td></tr> <tr><td>71 A4</td><td></td><td>1.1</td><td></td></tr> <tr><td>71 B4</td><td></td><td>1.3</td><td></td></tr> <tr><td>80 A4</td><td></td><td>1.72</td><td></td></tr> <tr><td>80 B4</td><td></td><td>2.14</td><td></td></tr> <tr><td>90 S4</td><td></td><td>2.89</td><td></td></tr> <tr><td>90 L4</td><td></td><td>3.61</td><td></td></tr> <tr><td>100 LA4</td><td></td><td>5.23</td><td></td></tr> <tr><td>100 LB4</td><td></td><td>6.8</td><td></td></tr> <tr><td>160 M4</td><td>1450</td><td>21.0</td><td>0.86</td></tr> <tr><td>160 L4</td><td></td><td>22.1</td><td></td></tr> <tr><td>180 M4</td><td>1455</td><td>34.5</td><td></td></tr> <tr><td>180 L4</td><td></td><td>41.8</td><td></td></tr> <tr><td>200 L4</td><td>1455</td><td>55.0</td><td></td></tr> <tr><td>225 S4K</td><td>1470</td><td>68.4</td><td></td></tr> <tr><td>225 M4K</td><td>1470</td><td>83.0</td><td></td></tr> <tr><td>250 M4K</td><td>1475</td><td>99.4</td><td>0.86</td></tr> <tr><td>315 S4</td><td></td><td>191</td><td>0.87</td></tr> <tr><td>315 M4</td><td>1490</td><td>226</td><td>0.88</td></tr> <tr><td>315 LA4</td><td></td><td>272</td><td>0.89</td></tr> <tr><td>315 LB4</td><td></td><td>339</td><td>0.89</td></tr> </tbody> </table>	Tipo	nn	In	cos $\phi$	56 B4			0.6	71 A4		1.1		71 B4		1.3		80 A4		1.72		80 B4		2.14		90 S4		2.89		90 L4		3.61		100 LA4		5.23		100 LB4		6.8		160 M4	1450	21.0	0.86	160 L4		22.1		180 M4	1455	34.5		180 L4		41.8		200 L4	1455	55.0		225 S4K	1470	68.4		225 M4K	1470	83.0		250 M4K	1475	99.4	0.86	315 S4		191	0.87	315 M4	1490	226	0.88	315 LA4		272	0.89	315 LB4		339	0.89	▼				
Tipo	nn	In	cos $\phi$																																																																																														
56 B4			0.6																																																																																														
71 A4		1.1																																																																																															
71 B4		1.3																																																																																															
80 A4		1.72																																																																																															
80 B4		2.14																																																																																															
90 S4		2.89																																																																																															
90 L4		3.61																																																																																															
100 LA4		5.23																																																																																															
100 LB4		6.8																																																																																															
160 M4	1450	21.0	0.86																																																																																														
160 L4		22.1																																																																																															
180 M4	1455	34.5																																																																																															
180 L4		41.8																																																																																															
200 L4	1455	55.0																																																																																															
225 S4K	1470	68.4																																																																																															
225 M4K	1470	83.0																																																																																															
250 M4K	1475	99.4	0.86																																																																																														
315 S4		191	0.87																																																																																														
315 M4	1490	226	0.88																																																																																														
315 LA4		272	0.89																																																																																														
315 LB4		339	0.89																																																																																														
	92	1.0	B12	<table border="1"> <thead> <tr> <th>Tipo</th> <th>nn</th> <th>In</th> <th>cos<math>\phi</math></th> </tr> </thead> <tbody> <tr><td>71 A6</td><td></td><td>0.94</td><td></td></tr> <tr><td>71 B6</td><td></td><td>1.23</td><td></td></tr> <tr><td>80 A6</td><td></td><td>1.47</td><td></td></tr> <tr><td>80 B6</td><td></td><td>1.9</td><td></td></tr> <tr><td>90 S6</td><td></td><td>2.49</td><td>0.71</td></tr> <tr><td>90 L6</td><td></td><td>3.24</td><td></td></tr> <tr><td>132 S6</td><td></td><td>6.7</td><td>0.79</td></tr> <tr><td>132 MA6</td><td>955</td><td>8.9</td><td>0.79</td></tr> <tr><td>132 MB6</td><td>950</td><td>11.8</td><td></td></tr> <tr><td>160 L6</td><td>965</td><td>22.5</td><td>0.82</td></tr> <tr><td>180 L6</td><td>970</td><td>29.5</td><td>0.83</td></tr> <tr><td>200 LA6</td><td></td><td>34.7</td><td>0.86</td></tr> <tr><td>200 LB6K</td><td></td><td>42.3</td><td>0.83</td></tr> <tr><td>225 M6K</td><td></td><td>57.0</td><td></td></tr> <tr><td>250 M6K</td><td></td><td>69.9</td><td></td></tr> <tr><td>280 S6K</td><td>985</td><td>83.2</td><td>0.84</td></tr> <tr><td>315 S6</td><td>990</td><td>135</td><td></td></tr> <tr><td>315 M6</td><td>990</td><td></td><td>0.85</td></tr> <tr><td>315 LA6</td><td>990</td><td>190</td><td>0.88</td></tr> </tbody> </table>	Tipo	nn	In	cos $\phi$	71 A6		0.94		71 B6		1.23		80 A6		1.47		80 B6		1.9		90 S6		2.49	0.71	90 L6		3.24		132 S6		6.7	0.79	132 MA6	955	8.9	0.79	132 MB6	950	11.8		160 L6	965	22.5	0.82	180 L6	970	29.5	0.83	200 LA6		34.7	0.86	200 LB6K		42.3	0.83	225 M6K		57.0		250 M6K		69.9		280 S6K	985	83.2	0.84	315 S6	990	135		315 M6	990		0.85	315 LA6	990	190	0.88	▼												
Tipo	nn	In	cos $\phi$																																																																																														
71 A6		0.94																																																																																															
71 B6		1.23																																																																																															
80 A6		1.47																																																																																															
80 B6		1.9																																																																																															
90 S6		2.49	0.71																																																																																														
90 L6		3.24																																																																																															
132 S6		6.7	0.79																																																																																														
132 MA6	955	8.9	0.79																																																																																														
132 MB6	950	11.8																																																																																															
160 L6	965	22.5	0.82																																																																																														
180 L6	970	29.5	0.83																																																																																														
200 LA6		34.7	0.86																																																																																														
200 LB6K		42.3	0.83																																																																																														
225 M6K		57.0																																																																																															
250 M6K		69.9																																																																																															
280 S6K	985	83.2	0.84																																																																																														
315 S6	990	135																																																																																															
315 M6	990		0.85																																																																																														
315 LA6	990	190	0.88																																																																																														
	101	1.0	D4	Aggiunti i pesi degli ESV																																																																																													

**Manuale uso e manutenzione / Use and maintenance manual / Betriebsanleitung****Motori elettrici trifase:****Three-phase electric motors:****Drehstrommotoren:**Reperibile sul sito [www.stmspa.com](http://www.stmspa.com)Available on [www.stmspa.com](http://www.stmspa.com) websiteErhältlich auf [www.stmspa.com](http://www.stmspa.com)**Motori VELA:****VELA Motors:****VELA Motoren:**Reperibile sul sito [www.stmspa.com](http://www.stmspa.com)Available on [www.stmspa.com](http://www.stmspa.com) websiteErhältlich auf [www.stmspa.com](http://www.stmspa.com)**ESV:****ESV:****ESV:**

Fornito allegato al prodotto e relativo alla sua configurazione

Supplied with the product and specific to its configuration

In der Anlage zum Produkt und in Bezug auf dessen Konfiguration

**Electronic line CT18IGBD1****12/06**

Questo catalogo annulla e sostituisce ogni precedente edizione o revisione.

I dati esposti nel catalogo non sono impegnativi e ci riserviamo il diritto di apportare eventuali modifiche senza darne preavviso, nell'ottica di un miglioramento continuo del prodotto.

*This catalogue cancels and replaces any preceding issue or revision.*

*The data provided in the catalogue are not binding; in line with our commitment to on-going product improvement, we reserve the right to make changes without prior notice.*

Dieser Katalog annulliert und ersetzt jede vorausgehende Ausgabe oder Revision.

Die im vorliegenden Katalog enthaltenen Daten sind nicht verpflichtend. Wir behalten uns diesbezüglich das Recht vor, ohne entsprechende Vorankündigungen und im Sinne einer kontinuierlichen Produktverbesserung eventuelle Änderungen antragen zu können.

Qualora questo catalogo non Vi sia giunto in distribuzione controllata, l'aggiornamento dei dati ivi contenuto non è assicurato.

*If you obtained this catalogue other than through controlled distribution channels, no warranty is made as to whether the data contained herein is up-to-date.*

Sollten Sie diesen Katalog nicht im Zuge eines kontrollierten Vertriebs erhalten haben, kann die Aktualisierung der darin enthaltenen Daten nicht gewährleistet werden.

In tal caso la versione più aggiornata è disponibile sul ns. sito internet:  
[www.stmspa.com](http://www.stmspa.com)

*When in doubt, you are welcome to download the latest up-to-date version available on our web site:  
[www.stmspa.com](http://www.stmspa.com)*

In diesem Fall finden Sie die aktuellste Version unter der Website:  
[www.stmspa.com](http://www.stmspa.com)