

# radicon

with you at every turn

# benzlers

with you at every turn

ER Worm Gears



**CHAIN & DRIVES**  **COMPLETE POWER TRANSMISSION**

**SERVICE & SUPPORT**

WA: (08) 9303 4966 | NSW: (02) 9674 8611  
[chainanddrives.com.au](http://chainanddrives.com.au)



Worm Gears  
CER-2.01GB0415

# PRODUCTS IN THE RANGE

Serving an entire spectrum of mechanical drive applications from food, energy, mining and metal; to automotive, aerospace and marine propulsion, we are here to make a positive difference to the supply of drive solutions.

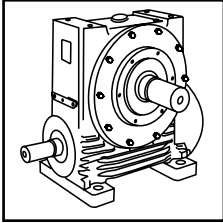

**Series A**  
Worm Gear units and geared motors in single & double reduction types

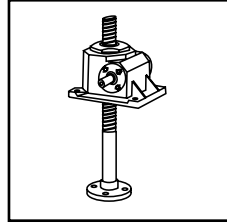

**Series BD**  
Screwjack worm gear unit

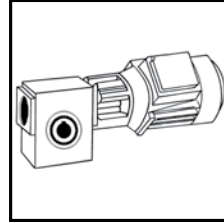

**Series BS**  
Worm gear unit

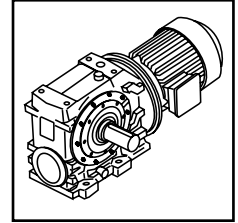

**Series C**  
Right angle drive helical worm geared motors & reducers

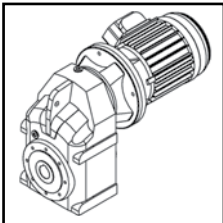

**Series F**  
Parallel shaft helical geared motors & reducers

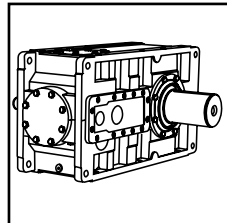

**Series G**  
Helical parallel shaft & bevel helical right angle drive gear units

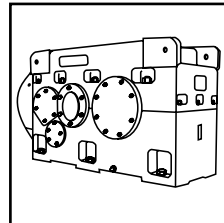

**Series H**  
Large helical parallel shaft & bevel helical right angle drive units

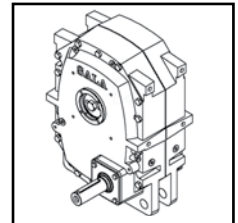

**Series J**  
Shaft mounted helical speed reducers

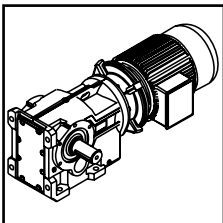

**Series K**  
Right angle helical bevel helical geared motors & reducers

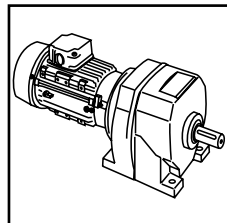

**Series M**  
In-line helical geared motors & reducers

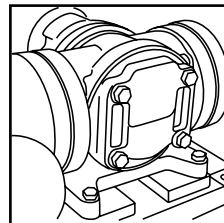

**Roloid Gear Pump**  
Lubrication and fluid transportation pump

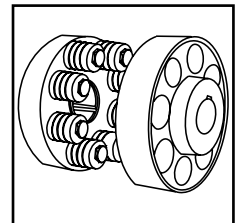

**Series X Cone Ring**  
Pin and bush elastomer coupling

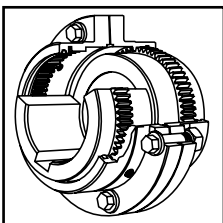

**Series X Gear**  
Torsionally rigid, high torque coupling

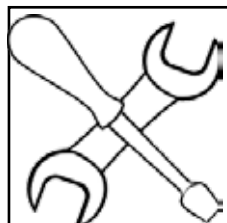

**Service & Repair**  
All brands and types

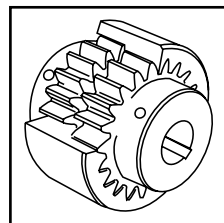

**Series X Nylon**  
Gear coupling with nylon sleeve

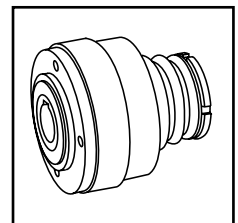

**Series X Torque Limiter**  
Overload protection device



We offer a wide range of repair services and many years experience of repairing demanding and highly critical transmissions in numerous industries.

We can create custom engineered transmission solutions of any size and configuration.

## INTRODUCTION

### Introduction

ER Series worm gear units are identical replacements for David Brown (Radicon) heavy duty worm gear units in all types :

- (a) Underdriven ER - U
- (b) Overdriven ER - O
- (c) Vertical ER - V

Which are identical in :

1. Foundation hole dimensions and size of hole
2. Distance from bottom base to input centreline
3. Input/Output shaft dimensions

Ratings are also comparable to David Brown (Radicon) worm gear units.

### Gear Case

Gear case is of streamlined design, rugged in construction, made of close-grain cast iron. It is completely oil-tight, dust-proof and capable of being installed in the open without a separate cover. The faces and bores are accurately bored and machined on latest precision machines to ensure perfect alignment and interchangeability.

### Worm/Worm Wheel

The worm is made of case-hardened alloy steel, carburised, ground and polished and is integral with the shaft. Bearing journals are accurately ground. Worm wheels are made of centrifugally cast phosphor-bronze rims, shrink fitted and brazed onto Cast Iron centres. Worms are generated on special-purpose worm milling machines, gas carburised and ground on CNC grinding machines.

Worm wheels are hobbled on precision hobbing machines with high accuracy hobs. Each and every wheel is checked to match with the master worms to ensure complete interchangeability. Right-hand threads are provided, unless otherwise specified.

### Bearings

The worms and worm wheels are supported on ball or roller anti-friction bearings of ample margin of safety to allow adequate journal as well as thrust loads. When a sprocket, gear etc is to be mounted on either shaft, then full details should be forwarded to our application engineers.

### Wheel Shaft

The wheel shaft is made of high tensile carbon steel. It is of large diameter to carry the torsional as well as bending loads which may be induced by overhung drives.

### Lubrication

Lubrication to gears and bearings is by splash of oil from the sump. Thus, no special care is required except for the occasional topping up of the oil to the required level. A large oil filler-cum-breather and an inspection cover is provided together with a drain plug and ventilator. Neoprene lip-type oil seals are fitted on input and output shaft. For very low input speed below 50 rpm. and heavy loads in sizes larger than 14", forced lubrication is required. In such cases details should be forwarded to our application engineers.

### Cooling

Air cooling is effected by means of standard polypropylene or metal fans which direct a continuous flow of air over the ribbed surface of the gear unit. The fan is designed to operate in both direction of rotation, and is so arranged in conjunction with the ribbing on the gear unit as to allow maximum heat dissipation.

### Holdback

Sprag type holdback can be fitted on all sizes of gears to prevent reverse rotation. In cases where holdback is required, the direction of rotation of the shaft should be mentioned.

### Power Ratings

The ratings indicated in the catalogue holds good for 12 hours of continuous running under uniform load being driven by electric motor. They give minimum gear life of 26,000 hours, subject to limitation of maximum oil temperature of 100°C under full load, 20°C ambient.

### Overloads

All the components of the reduction gears are so designed that they can withstand.

- \* 100 per cent overload for 15 seconds
- \* 50 per cent overload for one minute
- \* 40 per cent overload for 30 minutes and
- \* 25 per cent overload for two hours.

## LOAD CLASSIFICATION BY APPLICATIONS

**Table 1**

**U = Uniform load**

**M = Moderate shock load**

**H = Heavy shock load**

**† = Refer to our Application Engineers**

Driven Machine	type of load	Driven Machine	type of load	Driven Machine	type of load
		<b>Cranes</b>		log haul-incline	H
		main hoists	†	log haul-well type	H
		bridge travel	†	log turning device	H
		trolley travel	†	main log conveyor	H
				off bearing rolls	M
		<b>Crusher</b>		planer feed chains	M
		ore	H	planer floor chains	M
		stone	H	planer tilting hoist	M
		sugar	H	re-saw merry-go-round conveyor	M
				roll cases	H
		<b>Dredges</b>		slab conveyor	H
		cable reels	M	small waste conveyor-belt	U
		conveyors	M	small waste conveyor-chain	M
		cutter head drives	H	sorting table	M
		jig drives	H	tipple hoist conveyor	M
		manoeuvring winches	M	tipple hoist drive	M
		pumps	M	transfer conveyors	M
		screen drive	H	transfer rolls	M
		stackers	M	tray drive	M
		utility winches	M	trimmer feed	M
				waste conveyor	M
		<b>Dry dock cranes</b>			
		main hoist	†	<b>Machine tools</b>	
		auxiliary hoist	†	bending roll	M
		boom, luffing	†	punch press-gear driven	H
		rotating, swing or slew	†	notching press- belt driven	†
		tracking, drive wheels	†	plate planers	H
				tapping machine	H
		<b>Elevators</b>		other machine tools	
		bucket-uniform load	U	main drives	M
		bucket-heavy load	M	auxiliary drives	U
		bucket-continuous	U		
		centrifugal discharge	U	<b>Metal mills</b>	
		escalators	U	draw bench carriage	
		freight	M	and main drive	M
		gravity discharge	U	pinch, dryer and scrubber rolls-reversing	†
		man lifts	†	slitters	M
		passenger	†	table conveyors	
				non-reversing	
		<b>Fans</b>		group drives	M
		centrifugal	U	individual drives	H
		cooling towers		reversing	
		induced draft	†	wire drawing and flattening machine	M
		forced draft	†	wire winding machine	M
		induced draft	M		
		large, mine, etc	M	<b>Mill-rotary type</b>	
		large, industrial	M	ball	H
		light, small diameter	U	cement kilns	H
				dryers and coolers	H
		<b>Feeders</b>		kilns, other than cement	H
		apron	M	pebble rod	H
		belt	M	plain	H
		disc	U	wedge bar	H
		reciprocating	H	tumbling barrels	H
		screw	M		
				<b>Mixers</b>	
		<b>Food industry</b>		concrete mixers	
		beef slicer	M	-continuous	M
		cereal cooker	U	concrete mixers	
		dough mixer	M	-intermittent	M
		meat grinders	M	constant density	U
				variable density	M
		<b>Generators-not</b>		<b>Oil industry</b>	
		welding	U	chillers	M
				oil well pumping	†
		<b>Hammer mills</b>		paraffin filter press	M
				rotary kilns	M
		<b>Hoists</b>			
		heavy duty	H	<b>Paper mills</b>	
		medium duty	M	agitators, (mixers)	M
		skip hoist	M	barker-auxiliarieshydraulic	M
				barker-mechanical	H
		<b>Laundry washers</b>		barking drum	H
		reversing	M	beater and pulper	M
				bleacher	U
		<b>Laundry tumblers</b>		calenders	M
				calenders-super	H
		<b>Line shafts</b>		converting machine,	
		driving processing equipment	M	except cutters, platers	
		light	U	conveyors	U
		other line shafts	U	couch	M
				cutters-plates	H
		<b>Lumber industry</b>		cylinders	M
		barkers-hydraulicmechanical	M	dryers	M
		burner conveyor	M	felt stretcher	M
		chain saw and drag saw	H	felt whipper	H
		chain transfer	H	jordans	M
		craneway transfer	H		
		de-barking drum	H		
		edger feed	M		
		gang feed	M		
		green chain	M		
		live rolls	H		
		log deck	H		
				log haul	H
				presses	M
				pulp machine reel	M
				stock chest	M
				suction roll	M
				washers and thickeners	M
				winders	M
				<b>Printing presses</b>	†
				<b>Pullers</b>	
				barge haul	H
				<b>Pumps</b>	
				centrifugal	U
				proportioning	M
				reciprocating	
				single acting; 3 or more cylinders	M
				double acting; 2 or more cylinders	M
				single acting; 1 or 2 cylinders	†
				double acting; single cylinder	†
				rotary	
				gear type	U
				lobe, vane	U
				<b>Rubber and plastics industries</b>	
				crackers	H
				laboratory equipment	M
				mixed mills	H
				refiners	M
				rubber calenders	M
				rubber mill-2 on line	M
				rubber mill-3 on line	M
				sheeter	M
				tire building machines	†
				tire and tube press	
				openers	†
				tubers and strainers	M
				warming mills	M
				<b>Sand muller</b>	M
				<b>Sewage disposal equipment</b>	
				bar screens	U
				chemical feeders	U
				collectors	U
				dewatering screws	M
				scum breakers	M
				slow or rapid mixers	M
				thickeners	M
				vacuum filters	M
				<b>Screens</b>	
				air washing	U
				rotary-stone or gravel	M
				travelling water intake	U
				<b>Slab pushers</b>	M
				<b>Steering gear</b>	†
				<b>Stokers</b>	U
				<b>Sugar industry</b>	
				cane knives	M
				crushers	M
				mills	M
				<b>Textile industry</b>	
				batchers	M
				calenders	M
				cards	M
				dry cans	M
				dryers	M
				dyeing machinery	M
				knitting machines	†
				looms	M
				mangles	M
				nappers	M
				pads	M
				range drives	†
				slashers	M
				soapers	M
				spinners	M
				tenter frames	M
				washers	M
				winders	M
				<b>Windlass</b>	†

# SERIES ER

## EXPLANATION & USE OF RATINGS & SERVICE FACTORS

### Explanation And Use Of Ratings And Service Factors.

Gear unit selection is made by comparing actual loads with catalogue ratings. Catalogue ratings are based on a standard set of loading conditions whereas actual load conditions vary according to type of application. Service factors are therefore used to calculate an equivalent load to compare with catalogue ratings.

### Mechanical Ratings and Service Factor ( $F_M$ )

Mechanical ratings measure capacity in terms of life and/or strength assuming 12 hr/day continuous running under uniform load conditions. Catalogue ratings allow 100% overload at starting, breaking or momentarily during operations up to 12 hours per day.

**Table 2 - Mechanical Service Factor ( $F_M$ )**

Prime mover	Duration of service hrs per day service	Load classification - driven machine		
		Uniform	Moderate Shock	Heavy Shock
Electric motor, steam turbine or hydraulic motor	Under : 3	0.8	1	1.5
	3 to 10	1	1.25	1.75
	Over 10 to 24	1.25	1.5	3
Multi-cylinder internal, combustion engine	Under : 3	1	1.25	1.75
	3 to 10	1.25	1.5	2
	Over 10 to 24	1.5	1.75	2.25
Single cylinder internal, combustion engine	Under : 3	1.25	1.5	2
	3 to 10	1.5	1.75	2.25
	Over 10 to 24	1.75	2	2.5

- *For Units subject to frequent starts/stops and overloads, also applications where high inertia loads are involved e.g. crane travel drives, slewing motion etc, please contact our application engineers.*

### Thermal ratings and Thermal service factor ( $F_T$ )

Thermal ratings measure a unit's ability to dissipate heat, if they are not exceeded, the lubricant may overheat and break down resulting in failure of gear unit. Thermal ratings are affected by ambient temperature and not by mechanical considerations such as increased running time and shock loads. Catalogue ratings are given on 20°C ambient temperature allowing for a lubricant temperature rise to 100°C during operation as the unit transmit power and generate heat. Thermal ratings calculated with unit fan cooling. Thermal service factor  $F_T$  (Table No. 3) is used to modify the actual load according to prevailing ambient temperature.

**Table 3 - Thermal Service Factor ( $F_T$ )**

Ambient Temp °C	10	20	30	40	50	60
factor	0.87	1.00	1.16	1.35	1.62	1.97

If the ambient temperature is other than 20°C, divide the catalogue thermal rating by the factor from Table No. 3

## EXAMPLE SELECTIONS

### Example - 1

Worm reduction gear having input (worm) above the wheel required for belt conveyor where non-uniform material is fed on conveyor belt, operating for 8 hours per day. Speed required at conveyor shaft is 50 rpm. The gear unit is driven directly using coupling by 30 KW, 1500 rpm electric motor.

**Step : 1**      Ratio required      =       $\frac{\text{Input Speed}}{\text{Output Speed}} = \frac{1500}{50} = 30:1$

**Step : 2**

From Table No 1.

Drive m/c      -      Belt Conveyor  
 Material      -      Non uniform fed  
 Type of Load      -      Moderate Shock (M)

From Table No. 2

Mechanical service factor (Fm) = 1.25 for 8 hr/day operation

**Step : 3**

Input power      =      Motor Power x Fm  
                          =      30 x 1.25  
                          =      37.5 Kw

From Catalogue      -      Rating at Input 1500 rpm, Ratio 30:1

Gear unit size      :      10 Ratio - 30:1

Input Power      =      40 Kw

Gear unit/type/size :      10 ER-O, Ratio - 30:1

### Example - 2

Worm reduction gear unit underdriven type is required to drive a bucket elevator heavily loaded, operating 24 hours per day at 29 rpm, transmitting 30 KW. The gear unit is directly driven using coupling by a 1500 rpm electric motor. The ambient temperature is 30°C on plant.

**Step : 1**      Ratio required      =       $\frac{\text{Input Speed}}{\text{Output Speed}} = \frac{1500}{29} = 50:1$  (nearest standard ratio)

**Step : 2**

From Table No 1.

Drive m/c      -      Bucket Elevator (heavily Loaded)  
 Type of Load      -      Moderate Shock (M)

From Table No. 2

Mechanical service factor (Fm) = 1.50 for 24 hr/day continuous operation

**Step : 3**

Equivalent output power (mechanical)      =      30 x 1.5      = 45 Kw  
 Equivalent output torque (mechanical)      =       $\frac{9550 \times 45}{29}$       = 14818.96 Nm

From Catalogue.

Refer rating at input speed 1500 rpm, Ratio - 50:1.

Gear unit size 14, ratio 50:1 having output torque (mechanical) = 16457.4 Nm

Input Power (mechanical) = 62 Kw

**Step : 4**

From Table No. 3 Thermal service factor (Ft)      = 1.16

For an ambient temperature of 30°C

Equivalent output power (Thermal)      =      30 Kw x 1.16  
    = 34.8 Kw  
    =  $\frac{9550 \times 45}{29}$       = 11460 Nm.

## EXAMPLE SELECTIONS

### Step : 5

From the catalogue, the rating at input speed 1500 rpm, and ratio - 50:1, for a size 14" unit:

Output torque (thermal) = 10486.9 Nm, which is less than calculated equivalent

Output torque (thermal) = 11460 Nm

The higher gear unit size 17 ER-U, ratio - 50:1 should be selected.

Input speed 1500rpm, output torque (mechanical) = 29064 Nm, Input power (mechanical) = 110 Kw

Required Input power

$$= \frac{\text{Calculated equivalent output torque (Mech.)} \times \text{Rated power (Mech.)}}{\text{rated output torque (Mech.)} \times Fm}$$

$$= \frac{14818.96 \times 110}{29064 \times 1.5} = 37.39 \text{ Kw}$$

Nearest standard motor having 37Kw at 1500 rpm an be selected for the application.

# SERIES ER

## RATINGS

### Ratings At Input Speed 1450 RPM

GEAR RATIO	OUTPUT SPEED RPM	CAPACITY	SIZE OF UNIT			
			10	12	14	17
5	300	INPUT MECH. POWER (KW)	123	196	274	*
		OUTPUT MECH. TORQUE (Nm)	3700	5494	8225	*
		INPUT THERMAL POWER (KW)	90	119	162	*
		OUTPUT THERMAL TORQUE (Nm)	2708	3777	4857	*
7.5	200	INPUT MECH. POWER (KW)	92	128	184	*
		OUTPUT MECH. TORQUE (Nm)	4129	5700	8280	*
		INPUT THERMAL POWER (KW)	76	109	150	*
		OUTPUT THERMAL TORQUE (Nm)	3411	4807	6675	*
10	150	INPUT MECH. POWER (KW)	65	111	162	320
		OUTPUT MECH. TORQUE (Nm)	3807	6557	9635	19355
		INPUT THERMAL POWER (KW)	62	99	141	200
		OUTPUT THERMAL TORQUE (Nm)	3632	6165	8358	12224
15	100	INPUT MECH. POWER (KW)	58	81	150	249
		OUTPUT MECH. TORQUE (Nm)	4985	7132	13349	21877
		INPUT THERMAL POWER (KW)	56	76	110	177
		OUTPUT THERMAL TORQUE (Nm)	4813	6670	9790	15721
20	75	INPUT MECH. POWER (KW)	55	75	123	216
		OUTPUT MECH. TORQUE (Nm)	6303	8619	14288	25029
		INPUT THERMAL POWER (KW)	48	63	94	160
		OUTPUT THERMAL TORQUE (Nm)	5501	7240	10955	18366
25	60	INPUT MECH. POWER (KW)	45	68	110	172
		OUTPUT MECH. TORQUE (Nm)	6303	9380	14695	24365
		INPUT THERMAL POWER (KW)	39	50	72	135
		OUTPUT THERMAL TORQUE (Nm)	5463	6948	9947	19124
30	50	INPUT MECH. POWER (KW)	40	56	92	158
		OUTPUT MECH. TORQUE (Nm)	6494	9339	14652	26557
		INPUT THERMAL POWER (KW)	32	45	61	121
		OUTPUT THERMAL TORQUE (Nm)	5195	7505	9761	20337
40	37.5	INPUT MECH. POWER (KW)	34	51	76	119
		OUTPUT MECH. TORQUE (Nm)	7360	10830	16137	26063
		INPUT THERMAL POWER (KW)	25	37	48	93
		OUTPUT THERMAL TORQUE (Nm)	5412	7858	10193	20131
50	30	INPUT MECH. POWER (KW)	28	44	62	110
		OUTPUT MECH. TORQUE (Nm)	7131	11404	16457	29064
		INPUT THERMAL POWER (KW)	22	31	40	82
		OUTPUT THERMAL TORQUE (Nm)	5603	8741	10487	21300
60	25	INPUT MECH. POWER (KW)	24	37	55	78
		OUTPUT MECH. TORQUE (Nm)	7243	11092	17521	25327
		INPUT THERMAL POWER (KW)	18	28	34	45
		OUTPUT THERMAL TORQUE (Nm)	5432	8397	10702	17713
70	21.4	INPUT MECH. POWER (KW)	21	32	46	75
		OUTPUT MECH. TORQUE (Nm)	7310	11207	16716	27445
		INPUT THERMAL POWER (KW)	20	23	28	57
		OUTPUT THERMAL TORQUE (Nm)	6962	7880	10320	20457



# SERIES ER

## RATINGS

### Ratings At Input Speed 960 RPM

GEAR RATIO	OUTPUT SPEED RPM	CAPACITY	SIZE OF UNIT			
			10	12	14	17
5	200	INPUT MECH. POWER (KW)	99	152	223	*
		OUTPUT MECH. TORQUE (Nm)	4570	6835	9717	*
		INPUT THERMAL POWER (KW)	70	100	154	*
		OUTPUT THERMAL TORQUE (Nm)	3209	4450	6710	*
7.5	133	INPUT MECH. POWER (KW)	72	110	152	*
		OUTPUT MECH. TORQ;UE (Nm)	4928	7361	9835	*
		INPUT THERMAL POWER (KW)	57	80	132	*
		OUTPUT THERMAL TORQUE (Nm)	3880	5353	8535	*
10	100	INPUT MECH. POWER (KW)	51	92	134	268
		OUTPUT MECH. TORQUE (Nm)	4481	8187	11301	24310
		INPUT THERMAL POWER (KW)	49	70	111	160
		OUTPUT THERMAL TORQUE (Nm)	4305	6229	9359	14102
15	66.7	INPUT MECH. POWER (KW)	45	68	125	220
		OUTPUT MECH. TORQUE (Nm)	5863	8882	15627	28979
		INPUT THERMAL POWER (KW)	41	60	97	139
		OUTPUT THERMAL TORQUE (Nm)	5342	7838	12076	18349
20	50	INPUT MECH. POWER (KW)	42	62	102	209
		OUTPUT MECH. TORQUE (Nm)	7140	10565	16628	35528
		INPUT THERMAL POWER (KW)	33	49	84	132
		OUTPUT THERMAL TORQUE (Nm)	5610	8358	13298	21430
25	40	INPUT MECH. POWER (KW)	33	53	80	128
		OUTPUT MECH. TORQUE (Nm)	6776	11125	15922	27198
		INPUT THERMAL POWER (KW)	28	40	67	89
		OUTPUT THERMAL TORQUE (Nm)	5749	8530	13361	189114
30	33.4	INPUT MECH. POWER (KW)	30	48	73	120
		OUTPUT MECH. TORQUE (Nm)	7399	11884	17181	30973
		INPUT THERMAL POWER (KW)	24	35	58	80
		OUTPUT THERMAL TORQUE (Nm)	5919	65	13705	20419
40	25	INPUT MECH. POWER (KW)	26	42	60	80
		OUTPUT MECH. TORQUE (Nm)	8442	13381	18953	6282
		INPUT THERMAL POWER (KW)	19	31	36	62
		OUTPUT THERMAL TORQUE (Nm)	6007	9715	12135	20368
50	20	INPUT MECH. POWER (KW)	21	36	49	78
		OUTPUT MECH. TORQUE (Nm)	8244	13489	19281	31286
		INPUT THERMAL POWER (KW)	16	24	35	60
		OUTPUT THERMAL TORQUE (Nm)	6341	8986	13737	23780
60	16.7	INPUT MECH. POWER (KW)	17	30	39	72
		OUTPUT MECH. TORQUE (Nm)	8006	13293	18600	34174
		INPUT THERMAL POWER (KW)	13	22	26	50
		OUTPUT THERMAL TORQUE (Nm)	5947	9751	12302	23446
70	14.3	INPUT MECH. POWER (KW)	15	32	34	62
		OUTPUT MECH. TORQUE (Nm)	7263	11207	17820	33539
		INPUT THERMAL POWER (KW)	12	19	22	43
		OUTPUT THERMAL TORQUE (Nm)	6011	9335	12027	23261

# SERIES ER

## DIMENSIONS

### ER-U

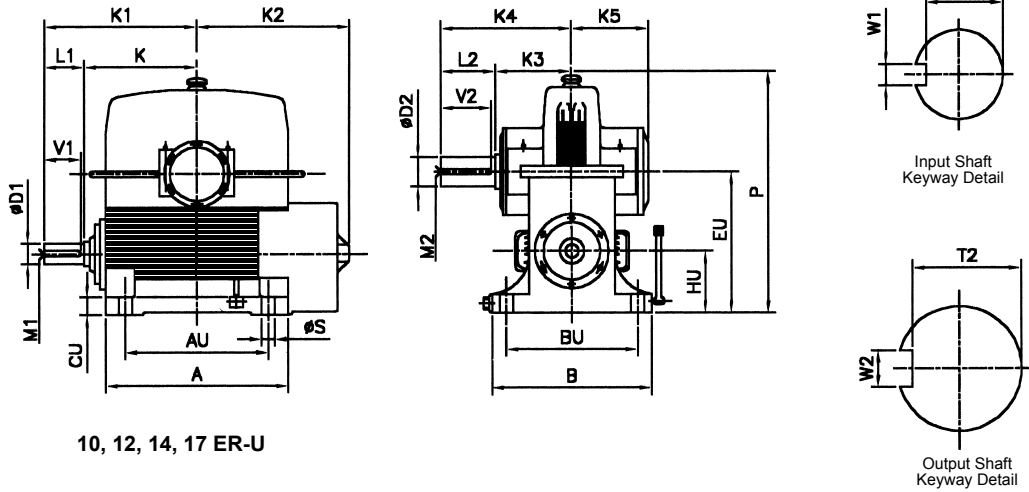

10, 12, 14, 17 ER-U

SIZES	MOUNTING DETAILS									INPUT SHAFT DETAILS							OUTPUT SHAFT DETAILS										
	A	AU	B	BU	CU	OS	HU	EU	P	D1	L1	V1	M1	Ti	W1	K	K1	K2	D2	L2	V2	M2	T2	W2	K3	K4	K5
10 ER-U	590	432	430	330	50	33	172	426	730	55.030	90	85	M20	49.0	16	335	425	460	85.035	152	147	M20	76.0	22	223	375	200
										55.011									85.013								
12 ER-U	690	521	540	368	55	33	191	495	860	60.030	124	120	M20	53.0	18	371	495	505	95.035	170	165	M20	86.0	25	243	413	210
										60.011									95.013								
14 ER-U	820	597	560	432	65	33	216	572	970	75.030	149	145	M20	67.5	20	423	572	545	120.035	190	185	M24	109	32	293	483	215
										75.011									120.013								
17 ER-U	920	762	600	508	75	33	254	686	1185	80.030	180	175	M20	71.0	22	520	700	650	140.040	203	200	M30	128	36	343	546	300
										80.011									140.015								

### ER-O

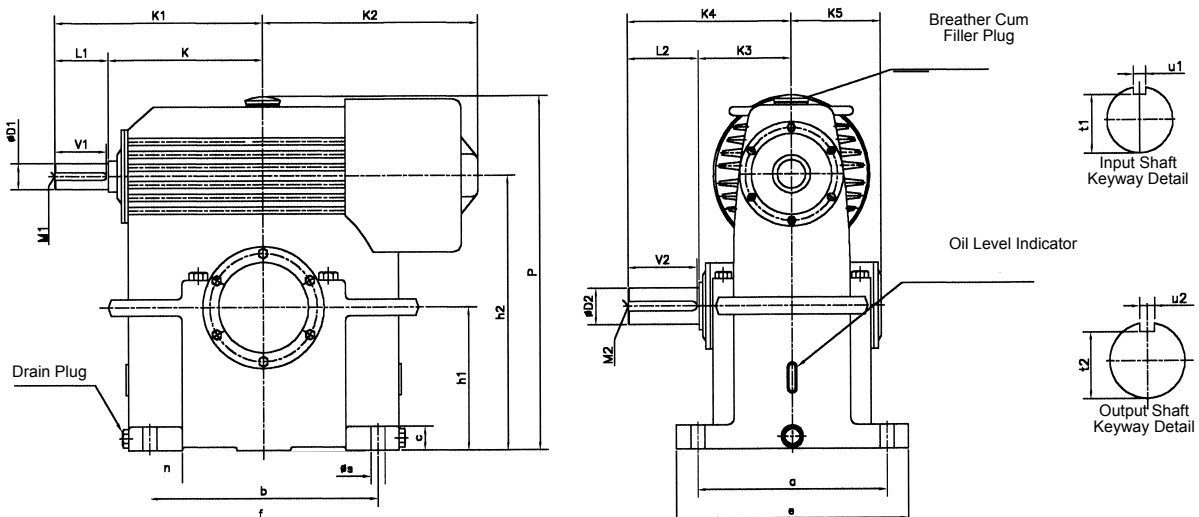

SIZES	MOUNTING DETAILS										INPUT SHAFT DETAILS							OUTPUT SHAFT DETAILS										
	a	b	c	e	f	n	s	h1	h2	P	D1	L1	V1	M1	Ti	W1	K	K1	K2	D2	L2	V2	M2	T2	W2	K3	K4	K5
10 ER-O	330	432	50	430	580	110	33	273	527	730	55.030	90	85	M20	49.0	16	335	425	460	85.035	152	147	M20	76.0	22	223	375	200
											55.011									85.013								
12 ER-O	368	521	55	540	630	125	33	330	635	860	60.030	124	120	M20	53.0	18	371	495	505	95.035	170	165	M20	86.0	25	243	413	210
											60.011									95.013								
14 ER-O	432	597	65	560	770	150	33	381	737	970	75.030	149	145	M20	67.5	20	423	572	545	120.035	190	185	M24	109	32	293	483	215
											75.011									120.013								
17 ER-O	510	750	75	600	920	170	33	460	892	1146	80.030	180	175	M20	71.0	22	520	700	650	140.040	203	200	M30	128	36	343	546	300
											80.011									140.015								

Key & Keyways as per B.S. 46 (part-1)

# SERIES ER

## DIMENSIONS

### ER-V

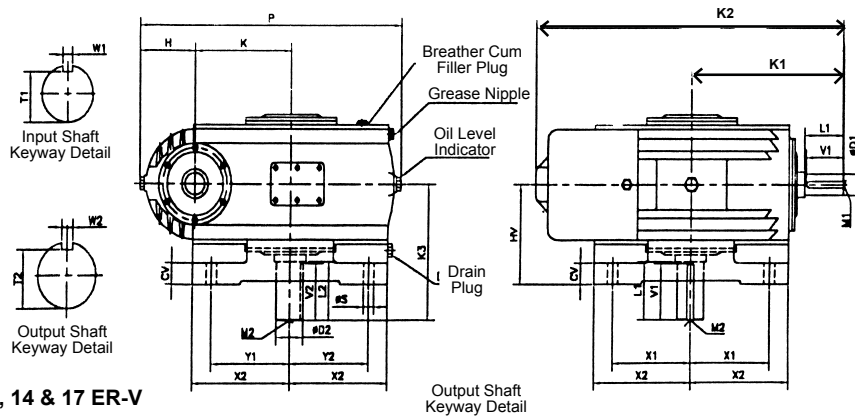

10, 12, 14 & 17 ER-V

SIZES	MOUNTING DETAILS										INPUT SHAFT DETAILS							OUTPUT SHAFT DETAILS								
	X1	X2	Y1	Y2	CV	os	HV	H	K	P	D1	L1	V1	M1	Ti	W1	K	K1	K2	D2	L2	V2	M2	T2	W2	K3
10 ER-V	260	310	260	235	55	33	279	180	254	734	55.030	90	85	M20	49.0	16	335	425	803	85.035	152	147	M20	76.0	22	375
											55.011									85.013						
12 ER-V	318	310	318	267	60	33	305	175	305	830	60.030	124	120	M20	53.0	18	371	495	936	95.035	170	165	M20	86.0	25	413
											60.011									95.013						
14 ER-V	356	350	356	305	65	33	330	200	356	975	75.030	149	145	M20	67.5	20	423	572	1093	120.035	190	185	M24	109	32	483
											75.011									120.013						
17 ER-V	432	500	432	432	75	40	406	238	432	1190	80.030	180	175	M20	71.0	22	520	699	1328	140.040	203	200	M30	128	36	546
											80.011									140.015						

Key & Keyways as per B.S. 46 (part-1)

### Mounting Positions And Shaft Handing

B - Breather Plug  
D - Drain Plug

L - Oil Level Indicator  
G - Grease Nipple

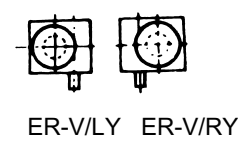
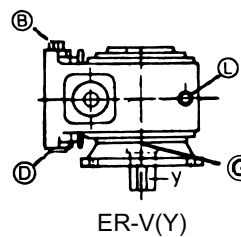
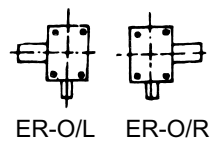
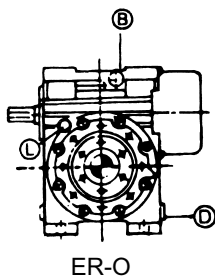
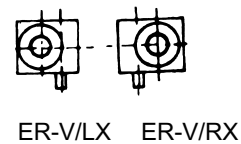
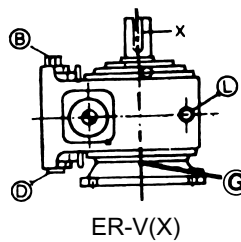
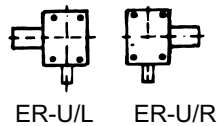
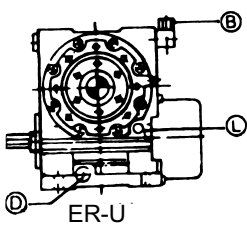

Replace G by plug for ER-V(X), V(Y) in bottom side.

### Actual Gear Ratio

Size	5	7.5	10	15	20	25	30	40	50	60	70
10	4.8	7.33	9.75	14.67	19.5	24.5	29.5	40	50	60	70
12	4.9	7.43	9.8	14.67	20.5	24.5	29.5	40	50	60	70
14	5.1	7.57	9.8	14.67	20.33	24.5	30.5	39	49	61	69
17	5.1	7.37	9.8	14.75	19.66	25.5	29.5	40	50	60	71

### Overhung Loads :

Whenever a sprocket, gear, sheave or pulley is mounted on the output shaft, a calculation should be made to determine the overhung load in Newtons on the shaft, using the formula:

$$P = \frac{K_w \times 9550 \times K}{N \times R}$$

Where, P = equivalent overhung load in Newtons

KW = power carried by shaft in Kilo Watts

N = r.p.m. of the shaft

R = pitch radius of sprocket, pinion, sheave or pulley in meter

K = factor

### Overhung Member

### K Factor

Sprocket	1.00
Spur Pinion	1.25
V-belt Sheave	1.50
Flat Belt Pulley	2.00

The calculated equivalent overhung load should be compared with the permissible values given in the table.

### Maximum Permissible Overhung Loads (Newtons) At Centre Of Wheel Shaft Extention At 1500 R.P.M. Input Speed.

RATIO	BEARING NEAR SHAFT EXTENSION	SIZE OF UNIT			
		10	12	14	17
5	Standard Bearings	19550	22310	34654	
	Reinforced Bearings	29800	34650	50000	
7.5	Standard Bearings	21000	27000	40500	
	Reinforced Bearings	32000	36650	54975	
10	Standard Bearings	31000	32909	49363	55000
	Reinforced Bearings	33000	46636	69954	99000
15	Standard Bearings	28000	33050	50875	63594
	Reinforced Bearings	40000	55120	87089	130633
20	Standard Bearings	26700	33000	52080	65100
	Reinforced Bearings	42000	57674*	92000*	138000*
25	Standard Bearings	28000	32636	65270	78824
	Reinforced Bearings	47700	57004*	117068*	151025*
30	Standard Bearings	29000	32800	67980	81576
	Reinforced Bearings	51000	57800*	127545*	172185*
40	Standard Bearings	29000	31325	76726	88071
	Reinforced Bearings	50450	63272*	140745*	182968*
50	Standard Bearings	31000	32080	83450	100148
	Reinforced Bearings	52700	63305*	154935*	185922*
60	Standard Bearings	30000	34650	85535	102642
	Reinforced Bearings	53000	67630*	138050*	179465*
70	Standard Bearings	26000	41580	86310	103572
	Reinforced Bearings	56045	70950*	143484*	186530*

\* Special Heat Treated Shaft is supplied

TRB = Taper Roller Bearing  
CRB = Cylindrical Roller Bearing

## LUBRICATION

### Weight & Oil Capacity

#### ER-U

Size	10	12	14	17
Net Weight (kgs.)	450	580	885	1260
Gross Weight (Kgs.)	595	900	1140	1700
Oil Capacity (ltrs.)	20	25	36	60

#### ER-V

Size	10	12	14	17
Net Weight (kgs.)	440	660	870	1575
Gross Weight (Kgs.)	560	845	1120	2000
Oil Capacity (ltrs.)	20	29	43	106

### Recommended Lubricants

#### Mineral Oil

Brand	Grade
BP International Ltd	CS 320 or GR-XP320
Castrol	Alpha Zn 320 or Alpha Sp-320 or Tribol 1100/320 TGQA
Caltex	Meropa 320
Esso Petroleum	Teresso 320 or Spartan 320
Fuchs	Renolin CKC 320
Mobil Oil Co.	Mobil DTE Oil AA or Mobilgear 632
Shell	Vitera Oil 320 or Omela 320

### POLYGLYCOL BASED SYNTHETIC LUBRICANT

Use of polyglycol based synthetic lubricant is also advisable to improve the transmitting capacity (rating) of gear units min. 20% as compared with use of mineral oil at same working temperature. This gear oil shows excellent non-ageing stability with favourable influence on efficiency.

#### Approved Synthetic Lubricants

Brand	Grade
Castrol	Tribol 800-220
Fuchs	Renolin PG 220

Special Note : Synthetic Lubricants must not be mixed with any other type of oil. The gear unit must be flushed while changing to or from this lubricant.

#### ER-O

Size	10	12	14	17
Net Weight (kgs.)	480	660	940	1380
Gross Weight (Kgs.)	610	920	1180	1800
Oil Capacity (ltrs.)	22	27	38	95

- First filling of oil is not supplied with the gear unit.
- First change of oil should be made after 500 hrs. of operation
- Subsequent oil change must be made after every 3000 hrs. of operation. This interval should not exceed 12 months.

## IMPORTANT

### Product Safety Information

**General** - The following information is important in ensuring safety. It **must** be brought to the attention of personnel involved in the selection of power transmission equipment, those responsible for the design of the machinery in which it is to be incorporated and those involved in its installation, use and maintenance.

Our equipment will operate safely provided it is selected, installed, used and maintained properly. As with any power transmission equipment **proper precautions must be taken** as indicated in the following paragraphs, to ensure safety.

**Potential Hazards** - these are not necessarily listed in any order of severity as the degree of danger varies in individual circumstances. It is important therefore that the list is studied in its entirety:-

#### 1) Fire/Explosion

(a) Oil mists and vapour are generated within gear units. It is therefore dangerous to use naked lights in the proximity of gearbox openings, due to the risk of fire or explosion.

(b) In the event of fire or serious overheating (over 300 °C), certain materials (rubber, plastics, etc.) may decompose and produce fumes. Care should be taken to avoid exposure to the fumes, and the remains of burned or overheated plastic/rubber materials should be handled with rubber gloves.

2) Guards - Rotating shafts and couplings must be guarded to eliminate the possibility of physical contact or entanglement of clothing. It should be of rigid construction and firmly secured.

3) Noise - High speed gearboxes and gearbox driven machinery may produce noise levels which are damaging to the hearing with prolonged exposure. Ear defenders should be provided for personnel in these circumstances. Reference should be made to the Department of Employment Code of Practice for reducing exposure of employed persons to noise.

4) Lifting - Where provided (on larger units) only the lifting points or eyebolts must be used for lifting operations (see maintenance manual or general arrangement drawing for lifting point positions). Failure to use the lifting points provided may result in personal injury and/or damage to the product or surrounding equipment. Keep clear of raised equipment.

#### 5) Lubricants and Lubrication

(a) Prolonged contact with lubricants can be detrimental to the skin. The manufacturer's instruction must be followed when handling lubricants.

(b) The lubrication status of the equipment must be checked before commissioning. Read and carry out all instructions on the lubricant plate and in the installation and maintenance literature. Heed all warning tags. Failure to do so could result in mechanical damage and in extreme cases risk of injury to personnel.

6) Electrical Equipment - Observe hazard warnings on electrical equipment and isolate power before working on the gearbox or associated equipment, in order to prevent the machinery being started.

#### 7) Installation, Maintenance and Storage

(a) In the event that equipment is to be held in storage, for a period exceeding 6 months, prior to installation or commissioning, we must be consulted regarding special preservation requirements. Unless otherwise agreed, equipment must be stored in a building protected from extremes of temperature and humidity to prevent deterioration.

The rotating components (gears and shafts) must be turned a few revolutions once a month (to prevent bearings brinelling).

(b) External gearbox components may be supplied with preservative materials applied, in the form of a "waxed" tape overwrap or wax film preservative. Gloves should be worn when removing these materials. The former can be removed manually, the latter using white spirit as a solvent.

Preservatives applied to the internal parts of the gear units do not require removal prior to operation.

(c) Installation must be performed in accordance with the manufacturer's instructions and be undertaken by suitably qualified personnel.

(d) Before working on a gearbox or associated equipment, ensure that the load has been removed from the system to eliminate the possibility of any movement of the machinery and isolate power supply. Where necessary, provide mechanical means to ensure the machinery cannot move or rotate. Ensure removal of such devices after work is complete.

(e) Ensure the proper maintenance of gearboxes in operation. Use only the correct tools and our approved spare parts for repair and maintenance. Consult the Maintenance Manual before dismantling or performing maintenance work.

#### 8) Hot Surfaces and Lubricants

(a) During operation, gear units may become sufficiently hot to cause skin burns. Care must be taken to avoid accidental contact.

(b) After extended running the lubricant in gear units and lubrication systems may reach temperatures sufficient to cause burns. Allow equipment to cool before servicing or performing adjustments.

#### 9) Selection and Design

(a) Where gear units provide a backstop facility, ensure that back-up systems are provided if failure of the backstop device would endanger personnel or result in damage.

(b) The driving and driven equipment must be correctly selected to ensure that the complete machinery installation will perform satisfactorily, avoiding system critical speeds, system torsional vibration, etc.

(c) The equipment must not be operated in an environment or at speeds, powers, torques or with external loads beyond those for which it was designed.

(d) As improvements in design are being made continually the contents of this catalogue are not to be regarded as binding in detail, and drawings and capacities are subject to alterations without notice.

The above guidance is based on the current state of knowledge and our best assessment of the potential hazards in the operation of the gear units. Any further information or clarification required may be obtained by contacting our Application Engineers.

AUSTRALIA

DENMARK

SWEDEN & NORWAY

UNITED KINGDOM



## **SERVICE & SUPPORT**

**WA: (08) 9303 4966 | NSW: (02) 9674 8611**  
**[chainanddrives.com.au](http://chainanddrives.com.au)**



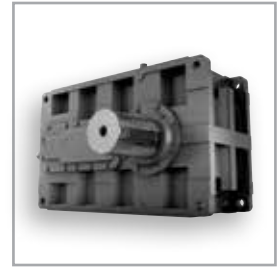
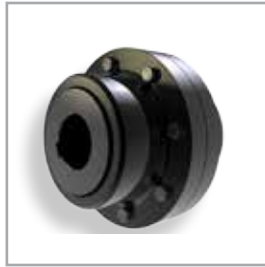
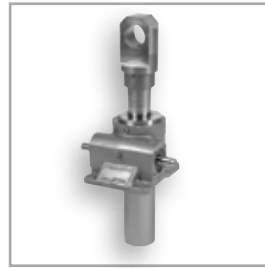

# CHAIN & DRIVES®

COMPLETE POWER TRANSMISSION

## SERVICE & SUPPORT

WA: (08) 9303 4966 | NSW: (02) 9674 8611

[chainanddrives.com.au](http://chainanddrives.com.au)

