

KCP

Tire Couplings



KOREA COUPLING CO., LTD.
PTE Manufacturer, Sales & Trade Biz

Coupling Selection

How to Select

Standard Selection

The Standard Selection may be used for engine driven, motor, or turbine applications. The following information is required:

- Application or equipment type (motor to pump, reducer to conveyor, etc.)
- Shaft diameters (mm)
- Gaps between shafts (mm)
- Speed (RPM)
- Horsepower or torque (Nm)

1. Rating : Determine system torque. Torque is calculated as follows :

$$\text{I . Torque (Nm)} = \frac{\text{kW} \times 9,550}{\text{RPM}} \quad \text{II . Torque (Kg.m)} = \frac{\text{kW} \times 974}{\text{RPM}}$$

2. Service Factor : Determine appropriate service factor from page. 5-6

3. Minimum Coupling Rating : Determine the required minimum coupling rating as follows :

$$\text{Minimum Coupling Rating} = \text{Service Factor} \times \text{Torque (Nm)}$$

4. Type : Select the appropriate coupling type

5. Size : Trace the Torque column to find the value that is equal or greater than value from Step 3.

6. Check : Check speed (RPM), bore, gap and dimensions.

Formula Selection

The Standard Selection should be used for most coupling selections.

The Formula Selection procedure below should be used for:

- High Peak Loads.
- Brake Applications (Brake disc or brake wheel is an integral part of coupling)

Using the Formula Selection and providing system peak torque and frequency, duty cycle, and brake torque rating will allow for a more refined selection.

1. High Peak Loads : Use formula A or B for applications which involve motors with higher than normal torque characteristics. Applications should also be those with intermittent operations, including shock loading, inertia effects due to starting and stopping, system-induced repetitive high peak torques. System Peak Torque is the maximum torque that can exist in the system. Select a coupling with a Torque Rating equal or greater than the Selection Torque calculated below:

A. Non-Reversing High Peak Torque : Selection torque (Nm) = System Peak Torque or

$$\text{System Torque (Nm)} = \frac{\text{System peak kW} \times 9549}{\text{RPM}}$$

B. Reversing High Peak Torque : Selection Torque (Nm) = 2 x System Peak Torque or

$$\text{System Torque (Nm)} = \frac{2 \times \text{Peak kW} \times 9549}{\text{RPM}}$$

2. Brake Applications : If the torque rating of the brake exceeds the motor torque, use brake rating as blow :

$$\text{Selection Torque (Nm)} = \text{Brake Torque Rating} \times \text{Service Factor}$$

Service Factors

Service Factors for Operation of Drive System

Application	Service Factor
AERATOR	2.0
AGITATORS	
Vertical and Horizontal Scenv, Propeller, Paddle	1.0
BARGE HAUL PULLER	1.5
BLOWERS	
Centrifugal	1.0
Lobe or Vane	1.25
CAR DUMPERS	2.5
CAR PULLERS	1.5
CLARIFIER or CLASSIFIER	1.0
COMPRESSORS	
Centrifugal	1.0
Rotary, Lobe or Vane	1.25
Rotary, Screw	1.0
With Flywheel and Gear between Compressor and Prime Mover	
1 Cylinder, single acting	3.0
1 Cylinder, double acting	3.0
2 Cylinders, single acting	3.0
2 Cylinders, double acting	3.0
3 Cylinders, single acting	3.0
3 Cylinders, double acting	2.0
4 or more cylinders, single acting	1.75
4 or more cylinders, double acting	1.75
CONVEYORS	
Apron, Assembly, Belt, Chain, Flight, Screw	1.0
Bucket	1.25
Live Roll, Shaker and Reciprocating	3.0
CRANES and HOIST	
Main Hoist	1.75
Skip Hoist	1.75
Slope	1.5
Bridge, Travel or Trolley	1.75
DYNAMOMETER	1.0
ELEVATORS	
Bucket, Centrifugal Discharge	1.25
Gravity Discharge	1.25
EXCITER, GENERATOR	1.0
EXTRUDER, PLASTIC	1.5
FANS	
Centrifugal	1.0
Cooling Tower	2.0
Forced Draft-Across the Line start	1.5
Forced Draft Motor driven thru fluid or electric slip clutch	1.0
Gas Recirculating	1.5
Induced Draft with damper control or blade cleaner	1.25
Induced Draft without controls	2.0
FEEDERS	
Apron, Belt, Disc, Screw	1.0
Reciprocating	2.5
GENERATORS	
Even Load	1.0
Hoist or Railway Service	1.5
Welder Load	2.0
GENERATORS	
Even Load	1.0

Application	Service Factor
Hoist or Railway Service	1.5
Welder Load	2.0
HAMMERMILL	1.75
LAUNDRY WASHER or TUMBLER	2.0
LINE SHAFTS	
Any Processing Machinery	1.5
MACHINE TOOLS	
Auxiliary and Traverse Drive	1.0
Bending Roll, Notching Press, Punch Press, Planer, Plate Reversing	1.75
Main Drive	1.5
METAL FORMING MACHINES	
Continous Caster	1.75
Draw Bench Carriage and Main Drive	2.0
Extruder	2.0
Farming Machine and Forming Mills	2.0
Slitters	1.0
Wire Drawing or Flattening	1.75
Wire Winder	1.5
Coilers and Uncoilers	1.5
MIXERS	
Concrete	1.75
Muller	1.5
PRESS, PRINTING	1.5
PUG MILL	1.75
PULVERIZERS	
Hammermil and Hog	1.75
Roller	1.5
PUMPS	
Boiler Feed	1.5
Centrifugal-Constant Speed	1.0
Frequent Speed Changes under Load	1.25
Descaling with accumulators	1.25
Gear, Rotary, or Vane	1.25
Reciprocating, Plunger Piston	
1 Cylinder, single or double acting	3.0
2 Cylinders, single acting	2.0
2 Cylinders, double acting	1.75
3 or more cylinders	1.5
Screw Pump, Progressing Cavity	1.25
Vacuum Pump	1.25
SCREENS	
Air Washing	1.0
Grizzly	2.0
Rotary Coal or Sand	1.5
Vibrating	2.5
Water	1.0
STEERING GEAR	1.0
STOKER	1.0
TIRE SHREDDER	1.5
TUMBLING BARREL	1.75
WINCH, MANEUVERING	
Dredge, Marine	1.5
WINDLASS	1.5
WOODWORKING MACHINERY	1.0

Service Factors and Reference

Service Factors for Operation of Drive System

Industry	Service Factor
AGGREGATE PROCESSING, CEMENT, MINING KILNS; TUBE, ROD and MILLS	
Direct or on L.S. shaft of Reducer, with final drive Machined Spur Gears	2.0
Single Helical or Herringbone Gears	1.75
Crushers, Ore or Stone	2.5
Dryer, Rotary	1.75
Grizzly	2.0
Hammermill or Hog	1.75
Tumbling Mill or Barrel	1.75
BREWING and DISTILLING	
Bottle and Can Filling Machines	1.0
Brew Kettle	1.0
Cookers, Continuous Duty	1.25
Lauter Tub	1.5
Mash Tub	1.25
Scale Hopper, Frequent Peaks	1.75
CLAY WORKING INDUSTRY	
Brick Press, Briquette Machine, Clay Working Machine, Pug Mill	1.75
DREDGES	
Cable Reel	1.75
Conveyors	1.25
Cutter head, Jig Drive	2.0
Maneuvering Winch	1.5
Pumps (Uniform load)	1.5
Screen Drive, Stacker	1.75
Utility Winch	1.5
FOOD INDUSTRY	
Beet Slicer	1.75
Botting, Can Filling Machine	1.0
Cereal Cooker	1.25
Dough Mixer, Meat Grinder	1.75
LUMBER	
Band Resaw	1.5
Circular Resaw, Cut-off	1.75
Edger, Head Rig, Hog	2.0
Log Haul	2.0
Planer	1.75
Rolls, Non-Reversing	1.25
Rolls, Reversing	2.0
Sawdust Conveyor	1.25
Slab Conveyour	1.75
Sorting Table	1.5
Trimmer	1.75
METAL ROLLING MILLS	
Coilers (Up or Down) Cold Mills only	1.5
Coilers (Up or Down) Hot Mills only	2.0
Coke Plants	
Pusher Ram Drive	2.5
Door Opener	2.0
Pusher or Larry Car Traction Drive	3.0
Continuous Caster	1.75
Colling Beds	1.5
Drawbench	2.0
Feed Rolls-Blooming Mills	3.0
Furnace Pushers	2.0
Hot and Cold Saws	2.0
Ingot Cars	2.0
Manipulators	3.0
Mill Tables	
Roughing Breakdown Mills	3.0
Hot Bed or Transfer, non-reversing	1.5
Runout, reversing	3.0
Runout, non-reversing, non-plugging	2.0
Reel Drives	1.75
Screwdown	2.0
Seamless Tube Mills	
Piercer	3.0
Thrust Block	2.0
Tube Conveyor Rolls	2.0
Reeler	2.0
Kick Out	2.0
Sideguards	3.0

Industry	Service Factor
Slitters, Steel Mill only	1.75
Lift	1.0
Travel	2.0
Straighteners	2.0
Unscramblers (Billet Bundle Busters)	2.0
Wire Drawing Machinery	1.75
OIL INDUSTRY	
Chiller	1.25
Oilwell Pumping (not over 150% peak torque)	2.0
Paraffin Filter Press	1.5
Rotary Kiln	2.0
PAPER MILLS	
Barker Auxiliary, Hydraulic	2.0
Barker, Mechanical	2.0
Barking Drum	
L.S. shaft of reducer with final drive-Helical or Herringbone Gear	2.0
Machined Spur Gear	2.5
Cast Tooth Spur Gear	3.0
Beater & Pulper	1.75
Bleachers, Coaters	1.0
Calender & Super Calender	1.75
Chipper	2.5
Converting Machine	1.25
Couch	1.75
Cutter, Felt Whipper	2.0
Dryer	1.75
Cylinder	1.75
Felt Stretcher	1.25
Fourdrinier	1.75
Jordan	2.0
Log Haul	2.0
Line Shaft	1.5
Press	1.75
Pulp Grinder	1.75
Reel, Rewinder, Winder	1.5
Stock Chest, Washer, Thickener	1.5
Stock Pumps, Centrifugal	
Constant Speed	1.0
Frequent Speed Changes Under load	1.25
Suction Roll	1.75
Vacuum Pumps	1.25
RUBBER INDUSTRY	
Calender	2.0
Cracker, Plasticator	2.5
Extruder	1.75
Intensive or Banbury Mixer	2.5
Mixing Mill, Refiner or Sheeter	
One or two in line	2.5
Three or four in line	2.0
Five or more in line	1.75
Tire Building Machine	2.5
Tire & Tube Press Opener (Peak Torque)	1.0
Tuber, Strainer, Pelletizer	1.75
Warming Mill	
One or two Mills in line	2.0
Three or more Mills in line	1.75
Washer	2.5
SEWAGE DISPOSAL EQUIPMENT	
Bar Screen, Chemical feeders, Collectors, Dewatering Screen, Grit Collector	1.0
SUGAR INDUSTRY	
Cane Carrier & Leveler	1.75
Cane Knife & Crusher	2.0
Mill Stands, Turbine Driver with all Helical or Herringbone, or Spur Gears with any Prime Mover	1.75
TEXTILE INDUSTRY	
Batcher	1.25
Calender, Card Machine	1.5
Cloth Finishing Machine	1.5
Dry Can, Loom	1.5
Dyeing Machinery	1.25
Mangle, Napper, Soaper	1.25
Spinner, Tenter Frame, Winder	1.5

Service Factors







Standard Selection

Service Factors for engine drives are required for applications where good flywheel regulation prevents torque fluctuations greater than $\pm 20\%$. For drives where torque fluctuations are greater or where the operation is near a serious critical or torsional vibration, a mass elastic study is necessary.

Number of Cylinders	4 or 5					6 or more				
Service Factor	1.5	1.75	2	2.25	2.5	1.5	1.75	2	2.25	2.5
Engine Service Factor	2.5	2.75	3	3.25	3.5	2.5	2.75	3	3.25	3.5

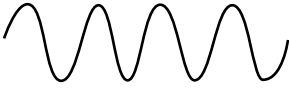
To use Engine Drive Service Factors, first determine application Service Factor from page 5-6. When Service Factor is greater than 2.0, or where 1, 2 or 3 cylinder engines are involved, refer complete application details to Korea Coupling for engineering review.

Service Factors are a guide, based on experience, of the ratio between coupling catalogue rating and system characteristics. The system characteristics are best measured with a torque meter.

Torque Demands Driven Machine	Typical applications for Driven Equipment	Typical Service Factor
	Constant torque such as Centrifugal Pumps, Blowers and Compressors.	1.0
	Continuous duty with some torque variations including Plastic Extruders, Forced Draft Fans.	1.5
	Light shock loads from Metal Extruders, Cooling Towers, Cane Knife, Log Haul.	2.0
	Moderate shock loading as expected from a Car Dumper, Stone Crusher, Vibrating Screen.	2.5
	Heavy shock load with some negative torques from Roughing Mills, Reciprocating Pumps, Compressors, Reversing Runout Talbes.	3.0
	Applications like Reciprocating Compressors with frequent torque reversals, which do not necessarily cause reverse rotations.	Refer to KCP

Tire Couplings



KCP Tire Couplings provide an ideal flexible coupling and include features such as Taper Bush fixing. Tire Couplings create a torsionally elastic coupling and offer a choice of flange combinations to suit most applications. The flanges are available in either Face or hub Taper Bush fitting, or can be bored to size, increasing the versatility for designers and engineers. The couplings can accommodate a standard distance between shaft ends through the addition of a spacer flange. This simple addition can facilitate equipment maintenance.

Tire Couplings are comprised of symmetrical shapes. The symmetry ensures balance and safety while minimizing the existing imbalance in any assembly. Replacing the tire and rubber parts is quick and simple and can be performed without displacing the equipment. This significantly reduces machine downtime. Maintenance costs are also reduced compared to other assemblies because Tire Coupling components do not require lubrication.

The flexible tire provides excellent shock-absorbing properties which reduce vibration and torsional oscillation. By isolating vibrations between machines and motors, workplace noise emissions are considerably reduced, greatly improving the workplace environment. In addition to mechanical isolation, Tire Couplings ensure perfect electrical isolation between shafts, removing a important cause of bearing failure.

Tire Coupling Types



KCS-L Type

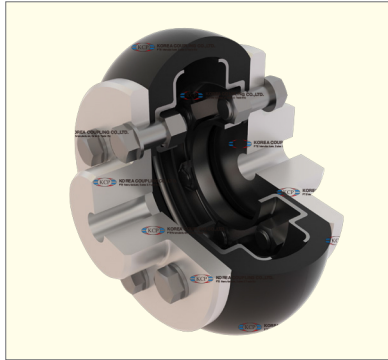

KCS-P Type

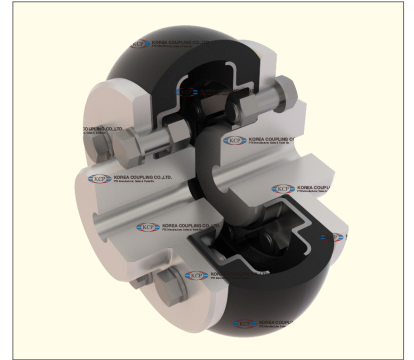

KCS-M Type

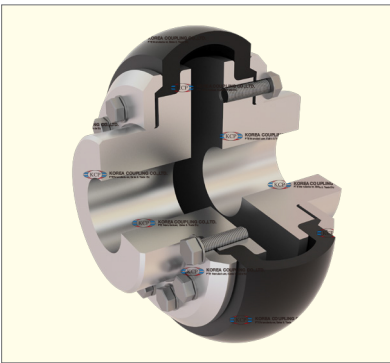

KRB Type



KRF Type

KCS-L Type

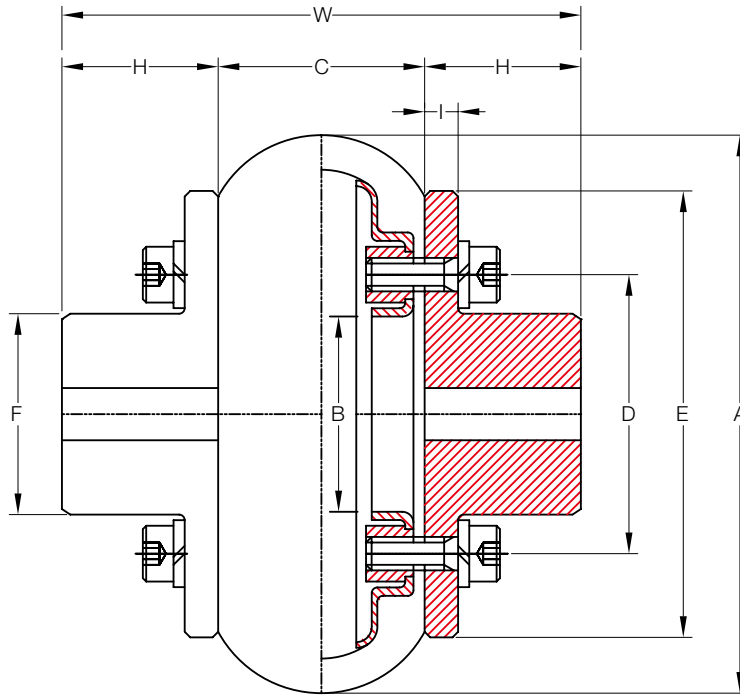

Size	Torque Rating (Nm)	Allow Speed RPM	Max Bore (mm)	Min Bore (mm)	Cplg Weight (Kg)	GD ² (Kg.cm-S ²)	Dimensions (Millimeters)									Hexa Bolt
							A	B	C	D	E	F	H	I	W	
100	50	5,000	22	8	1.1	0.0089	100	35	37	50	82	36	28	6	93	2 x 6 x M6 x 18L
120	98	4,500	28	10	2.0	0.0200	120	45	39	65	106	48	35	6	109	2 x 6 x M8 x 18L
140	147	4,200	35	24	3.0	0.0420	140	52	45	75	118	55	44	7	133	2 x 6 x M10 x 22L
160	216	4,000	42	24	4.5	0.0770	160	62	51	85	132	65	53	8	157	2 x 6 x M24 x 70L
185	294	3,600	48	34	6.6	0.1450	185	74	58	100	154	77	60	10	178	2 x 6 x M10 x 22L
220	490	3,200	55	34	11.8	0.3300	220	84	67	112	180	89	69	12	205	2 x 6 x M12 x 25L
265	980	2,600	75	40	21.7	0.9700	265	112	82	140	214	117	94	14	270	2 x 6 x M12 x 28L
340	1,617	2,100	95	44	46.5	3.2000	340	142	106	180	272	150	120	18	346	2 x 6 x M12 x 32L
445	4,900	1,600	128	54	110.0	12.2000	445	190	139	236	344	202	160	25	459	2 x 6 x M16 x 45L
550	9,800	1,200	170	64	187.0	32.0000	550	230	173	290	430	246	170	26	513	2 x 6 x M18 x 56L
700	19,600	1,000	220	84	394.0	91.0000	700	310	220	370	544	326	220	26	660	2 x 6 x M24 x 70L

* Coupling Weight is without Bore Machining

KCS-P Type

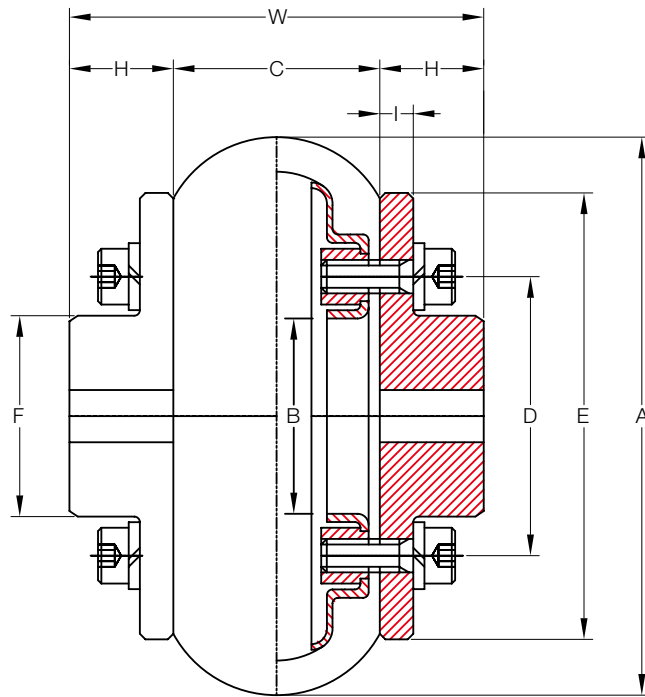

Size	Torque Rating (Nm)	Allow Speed RPM	Max Bore (mm)	Min Bore (mm)	Cplg Weight (Kg)	GD ² (Kg.cm-S ²)	Dimensions (Millimeters)									Hexa Bolt
							A	B	C	D	E	F	H	I	W	
100	50	5,000	22	8	1.0	0.0086	100	35	37	50	82	36	18	6	73	2 x 6 x M18 x 56L
120	98	4,500	28	10	1.9	0.0210	120	45	39	65	106	48	23	6	85	2 x 6 x M24 x 70L
140	147	4,200	35	14	2.8	0.0420	140	52	45	75	118	55	28	7	101	2 x 6 x M24 x 70L
160	216	4,000	42	18	4.3	0.0790	160	62	51	85	132	65	34	8	119	2 x 6 x M16 x 45L
185	294	3,600	48	24	6.5	0.1480	185	74	58	100	154	77	40	10	138	2 x 6 x M6 x 18L
220	490	3,200	55	30	10.4	0.3300	220	84	67	112	180	89	44	12	155	2 x 6 x M8 x 18L
265	980	2,600	75	40	18.8	0.9500	265	112	82	140	214	117	60	14	202	2 x 6 x M10 x 22L
340	1,617	2,100	95	44	41.5	3.4000	340	145	106	180	272	150	76	18	258	2 x 6 x M10 x 22L
445	4,900	1,600	128	54	87.4	11.6000	445	190	139	236	344	202	103	25	345	2 x 6 x M12 x 25L
550	9,800	1,200	170	64	165.0	30.0000	550	230	173	290	430	246	136	26	445	2 x 6 x M12 x 28L
700	19,600	1,000	220	84	355.0	84.0000	700	310	220	370	544	326	176	26	572	2 x 6 x M12 x 32L

* Coupling Weight is without Bore Machining

KCS-M Type

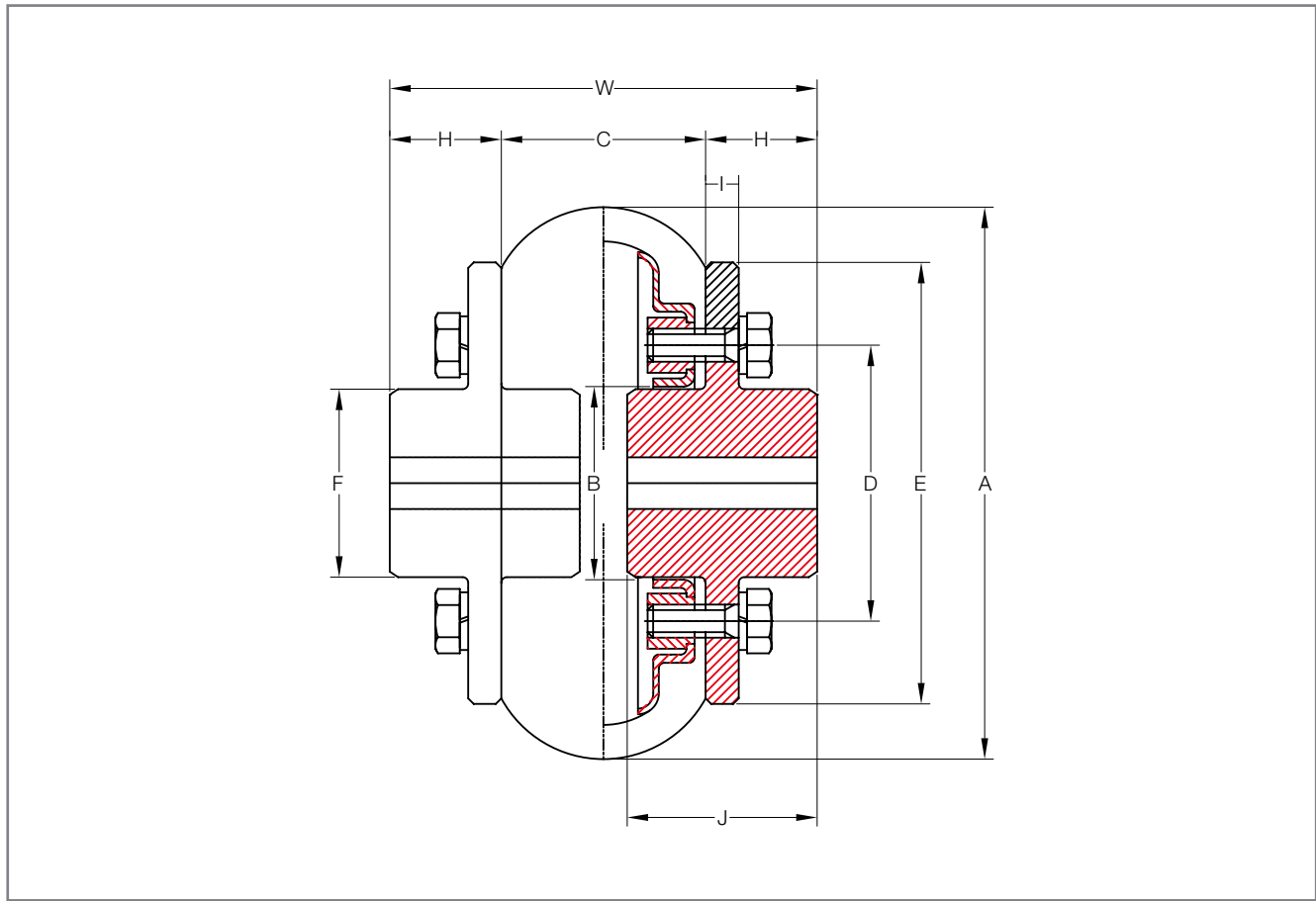

Size	Torque Rating (Nm)	Max Bore (mm)	Min Bore (mm)	Cplg Weight (Kg)	GD ² (Kg.cm-S ²)	Dimensions (Millimeters)											Hexa Bolt
						A	B	C	D	E	F	H	I	J	W		
100	50	20	8	1.0	0.0086	100	35	37	50	82	34	11	6	25	59	2 x 6 x M24 x 71L	
120	98	26	10	1.9	0.0210	120	45	39	65	106	44	18	6	32	75	2 x 6 x M18 x 50L	
140	147	30	14	2.8	0.0420	140	52	45	75	118	51	21	7	37	87	2 x 6 x M24 x 71L	
160	216	36	18	4.3	0.0790	160	62	51	85	132	61	27	8	45	105	2 x 6 x M6 x 18L	
185	294	44	24	6.5	0.1500	185	74	58	100	154	72	34	10	55	126	2 x 6 x M8 x 18L	
220	490	50	30	10.4	0.3200	220	84	67	112	180	82	36	12	60	139	2 x 6 x M10 x 20L	
265	980	66	40	18.8	0.9600	265	112	82	140	214	110	50	14	80	182	2 x 6 x M10 x 22L	
340	1,617	85	44	41.5	3.4000	340	142	106	180	272	140	61	18	100	228	2 x 6 x M12 x 25L	
445	4,900	115	54	87.4	11.4000	445	190	139	236	344	188	69	25	120	277	2 x 6 x M12 x 28L	
550	9,800	160	64	165.0	29.0000	550	230	173	290	430	228	97	26	160	367	2 x 6 x M12 x 28L	
700	19,600	210	84	355.0	83.0000	700	310	220	370	544	308	182	26	210	476	2 x 6 x M16 x 40L	

* Coupling Weight is without Disc and Bore Machining

KRB Type

KRF Type

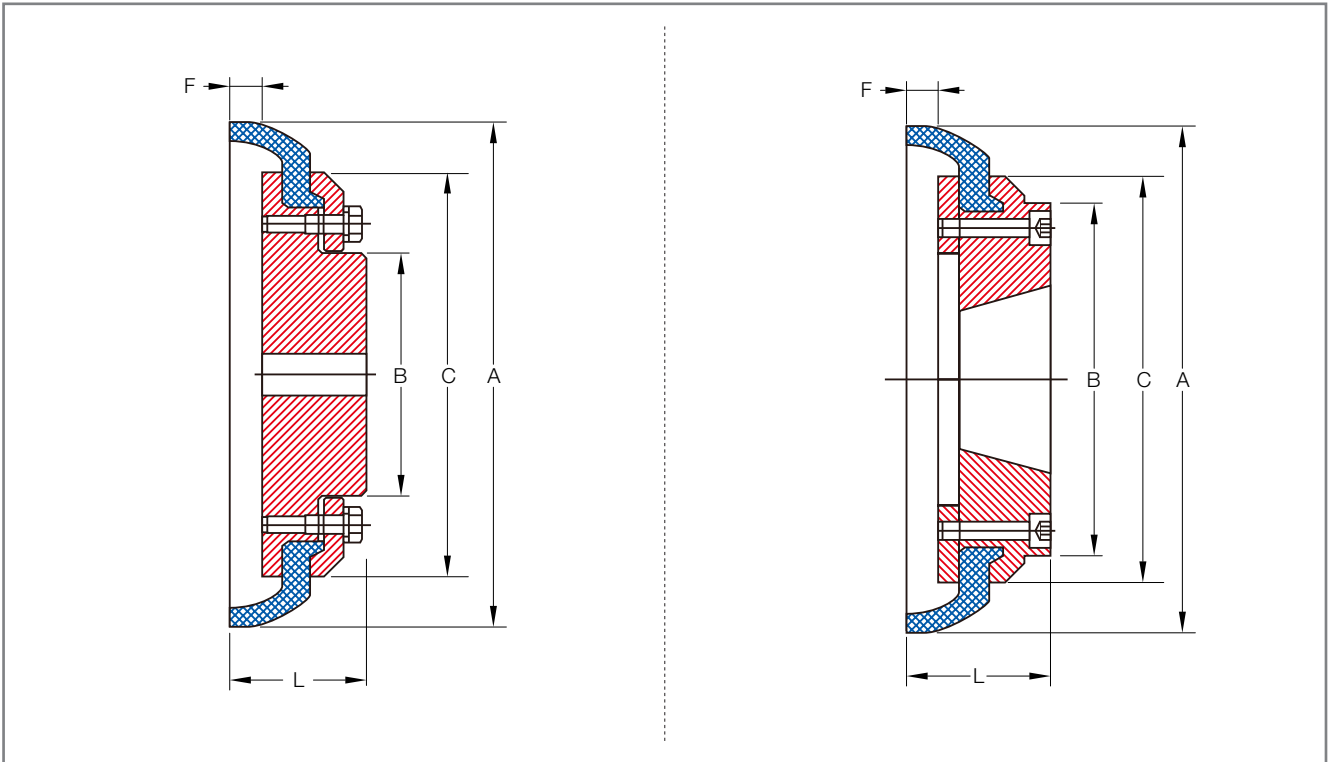

KRB Type

Size	Torque Rating (Nm)	Peak Torque Rating (Nm)	Allow Speed RPM	Max Bore (mm)	Cplg Weight (Kg)	Max. Parallel Misalignment (mm)	Max. End Float (mm)	Wrench Space (mm)	Dimensions (Millimeters)					Busing No.	Flange Fasteners		
									A	B	C	F	L		Size	Torque (Nm)	Per Flange
40	25	65	5,730	32	1.00	1.1	1.3	-	104	-	82	11	33.0	H7	M5	6	4
50	65	160	4,500	38	1.89	1.3	1.7	-	133	79	100	13	45.0	H7	M6	11	4
60	125	320	4,000	45	3.17	1.6	2.0	-	165	70	125	17	55.0	H7	M6	11	10
70	250	490	3,600	50	3.52	1.9	2.3	-	187	80	144	12	47.0	H7	M8	28	10
80	380	760	3,100	60	5.24	2.1	2.6	-	211	98	167	13	55.0	H7	M8	28	12
90	500	1,100	2,800	70	7.53	2.4	3.0	-	235	112	188	14	63.5	H7	M10	55	12
100	670	1,520	2,600	80	10.93	2.6	3.3	-	254	125	216	14	70.5	H7	M10	55	12
110	880	2,140	2,300	90	13.50	2.9	3.7	-	279	128	233	13	75.5	H7	M10	55	12
120	1,330	3,550	2,100	100	19.20	3.2	4.0	-	314	143	264	15	84.5	H7	M12	99	12
140	2,330	5,640	1,840	130	31.81	3.7	4.6	-	359	178	311	16	110.5	H7	M12	99	16
160	3,770	9,340	1,560	140	42.53	4.2	5.3	-	402	187	345	15	117.0	H7	M16	245	16
180	6,270	16,450	1,500	150	57.60	4.8	6.0	-	470	200	398	23	137.0	H7	M16	245	20
200	9,330	23,500	1,300	150	71.50	5.3	6.6	-	508	200	429	24	138.0	H7	M16	245	24
220	11,600	33,120	1,100	160	90.00	5.8	7.3	-	562	218	474	28	154.5	H7	M20	477	24
250	14,680	42,740	1,000	190	112.00	6.6	8.2	-	628	254	532	30	161.5	H7	M20	477	28

KRF Type

Size	Torque Rating (Nm)	Peak Torque Rating (Nm)	Allow Speed RPM	Max Bore (mm)	Cplg Weight (Kg)	Max. Parallel Misalignment (mm)	Max. End Float (mm)	Wrench Space (mm)	Dimensions (Millimeters)					Busing No.	Flange Fasteners		
									A	B	C	F	L		Size	Torque (Nm)	Per Flange
40	25	65	5,730	25	0.93	1.1	1.3	29	104	-	82	11	33.0	1008	M5	6	4
50	65	160	4,500	32	1.36	1.3	1.7	38	133	79	100	13	38.0	1210	M6	11	4
60	125	320	4,000	42	2.28	1.6	2.0	38	165	103	125	17	42.0	1610	M6	11	10
70	250	490	3,600	50	2.55	1.9	2.3	42	187	80	144	12	44.0	2012	M8	28	10
80	380	760	3,100	60	4.15	2.1	2.6	48	211	97	167	13	58.0	2517	M8	28	12
90	500	1,100	2,800	60	6.37	2.4	3.0	48	235	108	188	14	59.5	2517	M10	55	12
100	670	1,520	2,600	75	8.64	2.6	3.3	55	254	120	216	14	65.5	3020	M10	55	12
110	880	2,140	2,300	75	10.86	2.9	3.7	55	279	134	233	13	63.5	3020	M10	55	12
120	1,330	3,550	2,100	100	15.18	3.2	4.0	67	314	140	264	15	79.5	3525	M12	99	12
140	2,330	5,640	1,840	100	25.81	3.7	4.6	67	359	178	311	16	81.5	3525	M12	99	16
160	3,770	9,340	1,560	115	34.26	4.2	5.3	80	402	197	345	15	92.0	4030	M16	245	16
180	6,270	16,450	1,500	125	47.20	4.8	6.0	89	470	205	398	23	112.0	4535	M16	245	20
200	9,330	23,500	1,300	125	61.00	5.3	6.6	89	508	205	429	24	113.0	4535	M16	245	24
220	11,600	33,120	1,100	125	77.00	5.8	7.3	92	562	223	474	28	129.5	5040	M20	477	24



INNOBIZ
INNOBIZCOMPANY

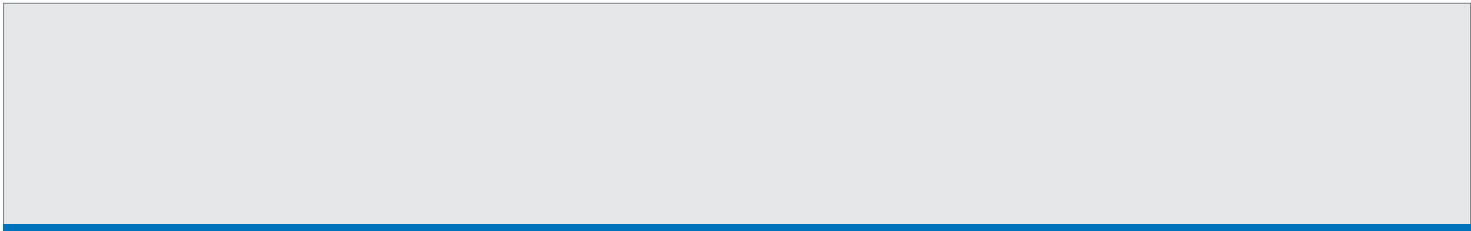

KOREA COUPLING CO., LTD.
PTE Manufacturer, Sales & Trade Biz

WA LOCATIONS

Unit 1 / 45 Inspiration Drive, Wangara WA 6065

(08) 9303 4966

Unit 16 / 51-53 Kewdale Road, Welshpool WA 6106

(08) 6314 1155

support@chainanddrives.com.au

NSW LOCATION

Unit 7 / 70 Holbeche Road, Arndell Park NSW 2148

(02) 9674 8611

salesnsw@chainanddrives.com.au



A Mechanical Equipment Group Company